

electrici

USER MANUAL



HD SMART LED TV

eiQ-32HDT2SM

LED TV

CONTENTS

SAFETY INFORMATION	3
CONNECTION AND PREPARATION OF TV	6
WHAT IS INCLUDED	6
INSTALLATION OF LEGS	6
WALL MOUNTING	7
BUTTONS AND INTERFACE	8
CONNECTING TO EXTERNAL DEVICES	10
REMOTE CONTROL	12
INSTALLATION OF BATTERIES	13
INITIAL SETUP	13
BASIC OPERATION	14
SETTING OF STANDBY MODE	14
SETTING THE INPUT SOURCE	14
TV MENU	15
PICTURE SETUP	15
SOUND SETUP	16
CHANNEL SETUP	17
SETTINGS	18
TIME	19
LOCK	19
LAUNCHER	20
TV	20
APP	20
MEDIA	21
TECHNICAL SPECIFICATION	22
SUPPORTED SIGNAL MODES	23
SIMPLE TROUBLESHOOTING	24
MANUFACTURER SUPPORT	25

SAFETY INFORMATION

- Read these instructions – All the safety and operating instructions should be read before this product is operated.
- Keep these instructions – The safety and operating instructions should be retained for future reference.
- Heed all warnings – All warnings on the appliance and in the operating instructions should be adhered to.
- Follow all instructions – All operating and usage instructions should be followed.
- Do not use this equipment near water – The appliance should not be used near water or moisture e.g. in a wet basement or near a swimming pool.
- Clean only with a dry cloth. Do not use solvents or petroleum-based fluids.
- Do not block any ventilation openings.
- Do not install near any heat sources such as radiators, stoves or other apparatus (including amplifiers) that produce heat.
- Do not tamper with the supplied plug. This plug is a BS1363 standard plug.
- Protect the power cord from being walked on or pinched, particularly at the plug and at the point where they exit from the appliance.
- Only use attachments/accessories specified by the manufacturer.
- Unplug the apparatus during lightning storms or when unused for long periods of time.
- Refer all servicing to qualified personnel. Servicing is required when the apparatus has been damaged in any way, such as power supply cord or plug is damaged, liquid has been spilled or objects have fallen into the apparatus or it has been exposed to rain or moisture, it does not operate normally or has been dropped.
- Please keep the unit in a well-ventilated environment.
- The TV should only be connected to a mains power supply with AC 100-240V~ 50/60Hz
- To prevent overload, do not share the same power supply socket with too many other electronic components.
- Do not place any connecting wires where they may be stepped on or tripped over.
- Do not place heavy items on the cable as this may cause damage.
- Hold the main plug, not the wires, when removing from a socket.
- Unplug immediately and seek professional help if the plug or cable is damaged, liquid has spilt onto the set, if accidentally exposed to water or moisture, if anything accidentally penetrates the ventilation slots or if the set does not work normally.
- Do not remove the safety covers. There are no user serviceable parts inside.
- To avoid battery leakage, remove exhausted batteries from the remote control when not in use for a long period.
- Do not block ventilation slots on the back cover. The TV can be placed in a

cabinet but ensure the guidance on clearances are followed.

- Do not tap or shake the TV screen, this may damage internal components.
- At full volume, prolonged listening may damage the users hearing.
- Diagrams within the manual are for illustrative purposes only, and as such there may be differences to the actual product received.
- This is a CLASS I product and as such requires an earth connection.

WARNING

Never place a television set in an unstable location. A television set may fall, causing serious personal injury or death. Many injuries, particularly to children, can be avoided by taking simple precautions such as:

- Use cabinets or stands recommended by the manufacturer of the television.
- Only use furniture that can safely support the television set.
- Ensure the television is not overhanging the edge of the supporting furniture.
- Do not place the television on tall furniture (for example, cupboards or bookcases) without anchoring both the furniture and the television to a suitable support.
- Do not place the television set on cloth or other materials that may be located between the television set and the supporting furniture.
- Educate children about the dangers of climbing on furniture to reach the television or its controls.

If your existing television set is being retained and relocated, the same considerations as above should be applied.

WARNING

To reduce the risk of fire or electric shock, do not expose this apparatus to rain or moisture. The apparatus shall not be exposed to dripping or splashing and objects filled with liquids, such as vases, shall not be placed on or next to the apparatus.

WARNING

The wall plug socket is used as a disconnection device and should remain readily accessible.

CAUTION

Danger of explosion if the battery is incorrectly replaced.
Replace only with the same or equivalent type.
Batteries shall not be exposed to excessive heat such as direct sunlight, fire or the like. Used batteries should be recycled appropriately.

CAUTION

To reduce the risk of electric shock, DO NOT remove the cover (or back). No user serviceable parts inside. Refer servicing to qualified service personnel.

ATTENTION

- Place the TV on a firm and flat surface, leaving a space of at least 10cm around the set and 30cm from the top of the set to the ceiling or cabinet. Ensure the TV is positioned close to the wall to avoid it falling when pushed.

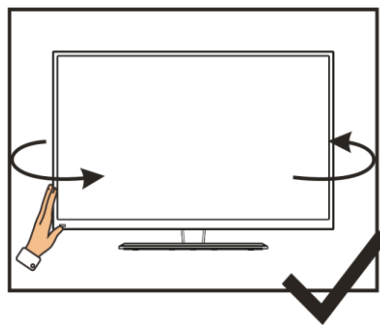
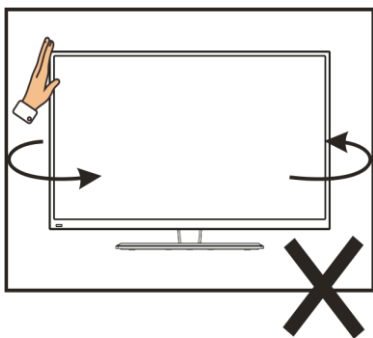
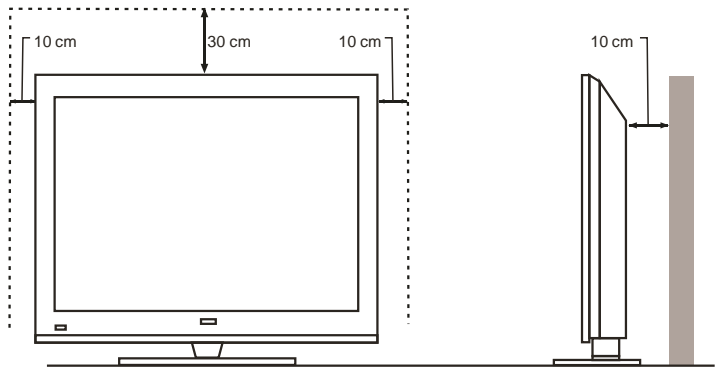

- When twisting the TV set, do not hold the top of the TV, you should twist from the base.

- When lifting the TV, do not use one hand to handle it, you should lift the TV using two hands, ensuring pressure is not put on the screen itself.

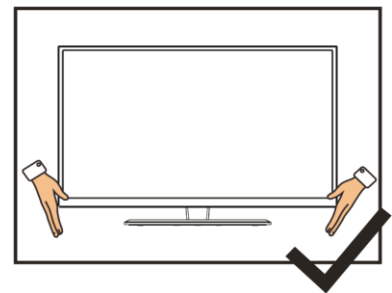
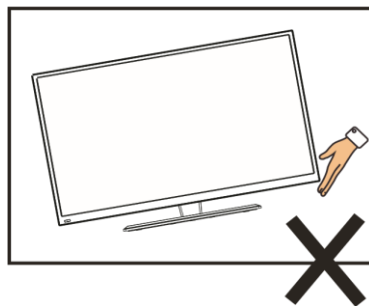

CONNECTION AND PREPARATION OF THE TV

WHAT IS INCLUDED



TV Set



Remote Control
(2 x AAA Batteries)



User Manual



4 Screws

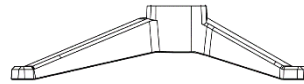

2 Legs

INSTALLATION OF LEGS

- 1 Place the TV with the front facing downwards on a soft cloth pads on a desk.
- 2 Insert the legs into the sockets on the base of the TV.
- 3 Insert the screws into the sockets and tighten them with a screwdriver. Do not use an electric screwdriver, or similar.

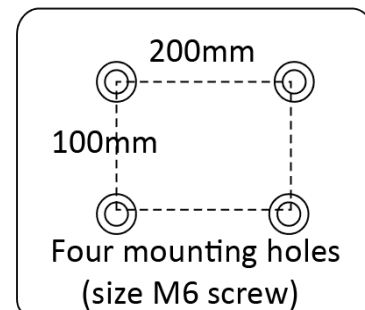
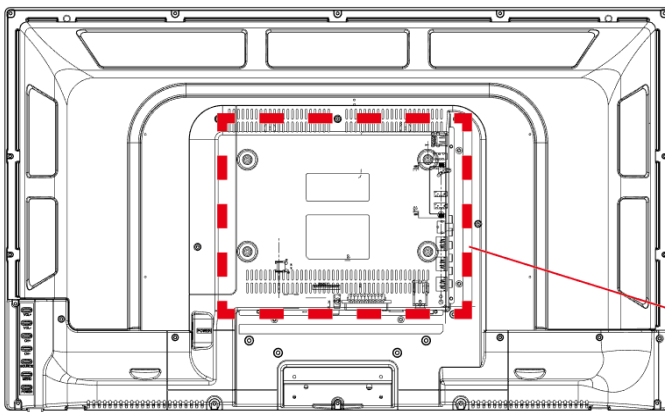

WALL MOUNTING

- The TV is provided with mounting holes for a VESA approved wall mounting bracket (not supplied).
- The VESA mounting pattern is :
200x100mm and the size of the bolts is 4 x M6 x 10(not supplied).
- Do not use bolts longer than the size specified above for your model or damage will occur to the internal components.

NOTES:

- Do not install this product until this manual has been read and understood thoroughly. Please keep these instructions for future reference.
- Due to the heavy weight and dimensions of the LCD screens and their fragile nature, we recommend that they are unpacked and assembled by 2 people and professional installers are used to wall mount them (Wall mounting is optional). If you do not understand the instructions, or are unsure how to install this product, please contact a professional for assembly advice and assistance.
- Careful consideration should be made regarding the location the television is to be wall mounted as some walls are not suitable for installation. If the television is to be mounted on drywall, the mount must be anchored into a wooden stud, concrete block or brick behind the drywall. Installing on drywall alone will not support the weight of the display.
- When drilling holes, it is particularly important to take care of electrical cables, water or gas pipes in the wall. Please follow the instructions provided by the wall bracket manufacturer and ensure that all fixing screws supplied are used.
- electriQ and its distributors and dealers are not liable or responsible for damage or injury caused by improper installation, improper use or failure to observe these safety instructions. In such cases any guarantee will expire.

BUTTON FUNCTIONS

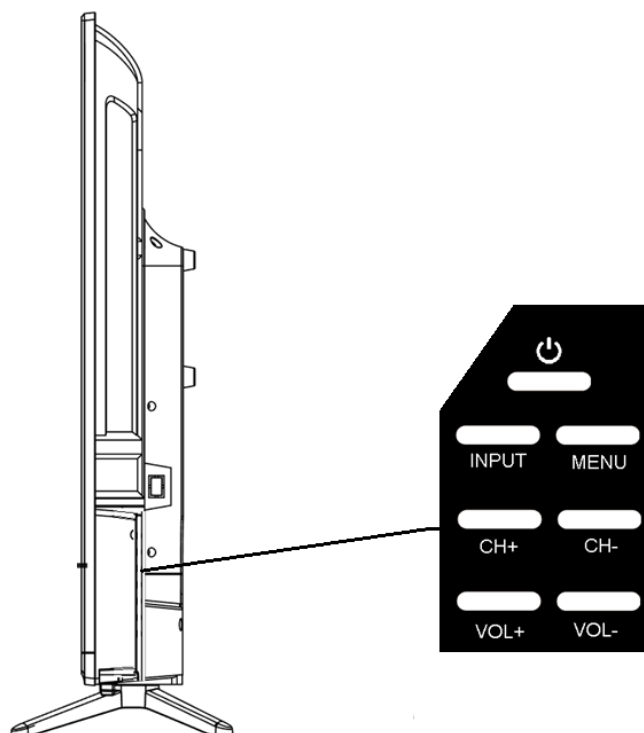

 POWER BUTON	To turn the TV ON/OFF
INPUT BUTTON	To select the input source.
MENU BUTTON	To enter the main menu.
CH+ BUTTON	To select the next channel
CH- BUTTON	To select the previous channel
VOL+ BUTTON	To increase the volume.
VOL- BUTTON	To decrease the volume.

INPUT / OUTPUT TERMINALS

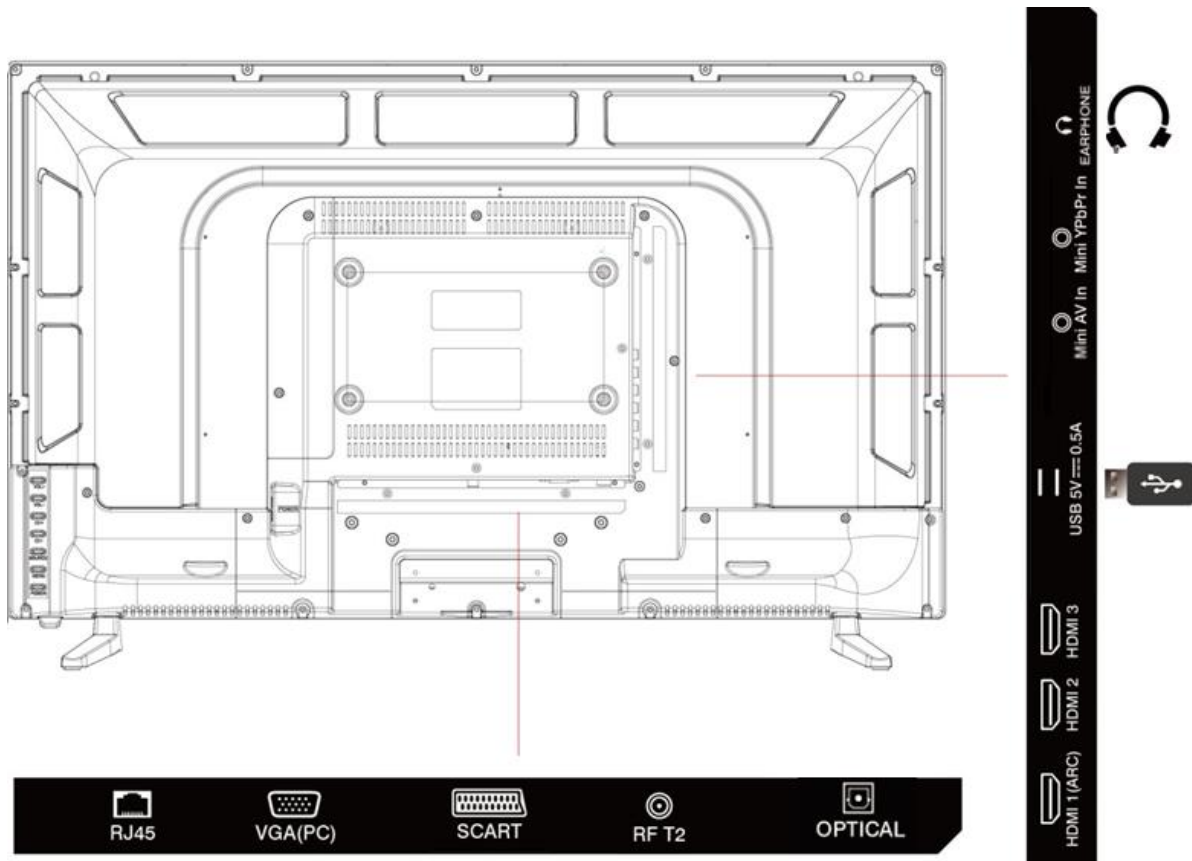

- **RJ45:** Network port
- **VGA:** PC Video input.
- **SCART Socket:** For connecting older equipment using a SCART lead.
- **RF:** Antenna connection.
- **HDMI x3:** For connecting DVD players, set top boxes, games consoles, etc.
- **Optical Digital:** Digital audio output, for use with compatible sound bars / audio equipment.
- **Mini AV Input:** External AV signal input and relevant right/left sound channel input.
- **Mini YPbPr Input:** Connect to the YPbPr video output terminal of the DVD player
- **Headphone Socket:** Connect headphones, or can be used for compatible Soundbars / audio equipment.
- **USB x2:** Provides access to SMART TV. Connect smart remotes, keyboards, gaming accessories or USB flash drive for DTV recording, Timeshift or media playback.

NOTE: Only connect low power USB flash drives or externally powered hard drives to the USB ports as they only provide 0.5 Amps power.

CONNECTING TO EXTERNAL DEVICES

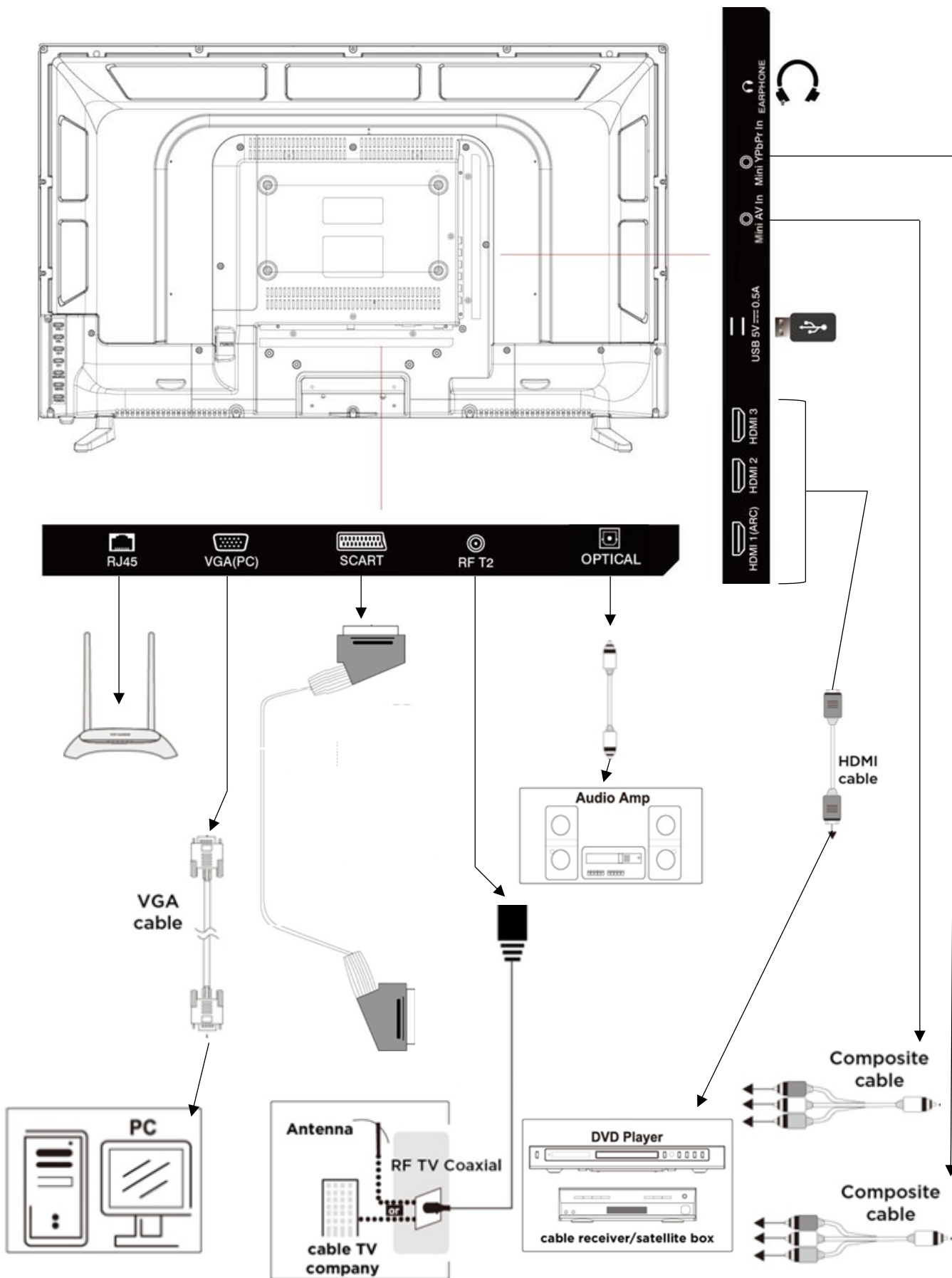

REMOTE CONTROL

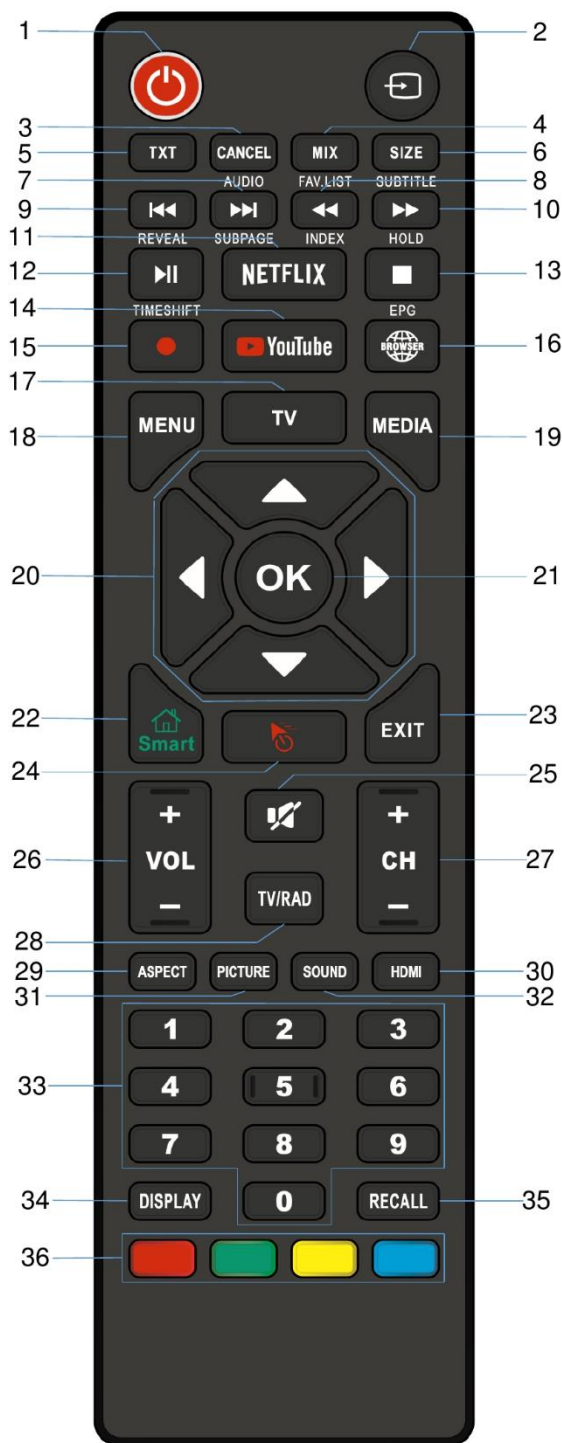

1. STANDBY: Turn the TV ON/OFF
2. SOURCE: Select the signal source
3. CANCEL (within TXT): Cancel the TXT on screen AUDIO: Select TV audio mode between stereo/mono (While playing DVD/multimedia): Switch audio channel.
4. MIX (Within TXT): Set transparency FAV LIST: Favorite channel list.
5. TXT: Enter or exit teletext.
6. SIZE (within TXT): Sets size of the characters. SUBTITLE (DTV mode): Select subtitle mode.
7. ⏮ (MEDIA mode): Next file or chapter. SUBPAGE (within txt): View Subpage
8. ⏪ (MEDIA mode): Fast rewind INDEX: Display the index page.
9. ⏩ (MEDIA mode): Previous file or chapter. REVEAL: Reveal hidden information
10. ⏭ (MEDIA mode): Fast forward. HOLD: Hold the current page.
11. NETFLIX: Open NETFLIX*.
12. ⏸ (MEDIA mode): Press to pause / play. TIMESHIFT (Within DVR): Timeshift
13. ⏹ (MEDIA mode): Press to stop playback. EPG Enter or exit the electronic program guide and access recording functions
14. YOUTUBE: Open YOUTUBE*.
15. RECORD: DTV mode record to USB stick.
16. BROWSER: Launch internet browser.
17. TV: Enter TV Mode
18. MENU: Enter the Main Menu
19. MEDIA: Enter Media playback mode
20. DIRECTION BUTTONS: used for menu navigation.
21. ENTER: Confirm or Enter.
22. SMART: Enter SMART mode.
23. POINTER: Turn the pointer ON/OFF.
24. EXIT: Exit the current Menu.
25. MUTE: Mute the sound.
26. VOL +: Increase the volume VOL -: Decrease the volume
27. CH+: Next Channel CH-: Previous Channel
28. TV/RAD: Change between TV and Radio Modes
29. ASPECT: Press repeatedly to select the desired screen size.
30. HDMI: Set HDMI options
31. PICTURE: Set picture options
32. SOUND: Set sound options
33. 0-9: Press the buttons to select a channel
34. DISPLAY: Display the information for the current video / audio.
35. RECALL: Return to previous channel.
36. RED: Access the red item or page. GREEN: Access the green item or page. YELLOW: Access the yellow item or page. BLUE: Access the blue item or page.

*Availability of Netflix and YouTube features is dependent on the TV model.

HOW TO PROGRAM BUTTONS

1. Press and hold OK and 2 for 3 seconds. The LED will be illuminated.
2. Press the button on the electriQ remote to program. The LED will flash slowly.
3. With the other remote pointing at the end of the electriQ remote, press the button required on the other remote. The LED will flash quickly.
4. Repeat steps 2 and 3 for other buttons.
5. Hold OK for 3 seconds to save the changes.

NOTE: To use the mouse feature of the remote, the dongle should be inserted into one of the USB ports on the side of the television

INSTALLATION OF BATTERIES

- 1 Remove the battery cover from the rear of the remote control.
- 2 Install two AAA 1.5V batteries. (Ensure the correct polarity of the batteries.)
- 3 Replace the battery cover.

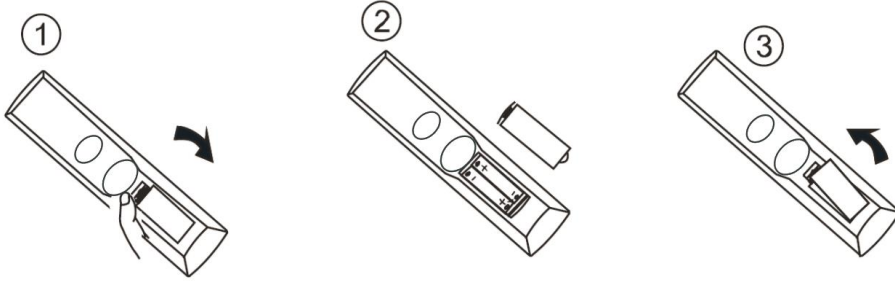

Please take out of the batteries from the remote when it is not going to be used for a long period of time.

If the remote control doesn't work properly, please carry out the following checks.

- Check the TV is turned on.
- Check the polarity of the batteries are correct.
- Check the batteries and replace if necessary
- Check the plug is fully inserted and the socket is switched on.
- Check there are no special fluorescent light or neon light which could interfere with remote signals.

INITIAL SETUP

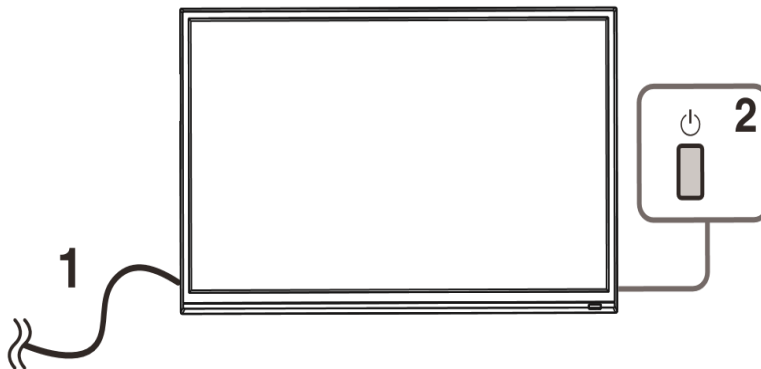

1. Connect your TV to the power outlet.
2. Connect your aerial and/or set top box to the television.
3. Press the POWER button on the remote to turn on the TV.
CAUTION: Always disconnect the TV from the power outlet when the TV will not be used for a long period of time. The POWER button on the television and remote is only used for switching the TV into standby and does not disconnect the device from the mains voltage. To completely disconnect the mains voltage, please remove the plug from the socket.
4. Use the ▼/▲/◀/▶ buttons on the remote to follow the setup guide on screen.
- 5.



NOTE: To use the mouse feature of the remote, the dongle should be inserted into one of the USB ports on the side of the television

SET-UP GUIDE

Press the OK button to initiate the setup.

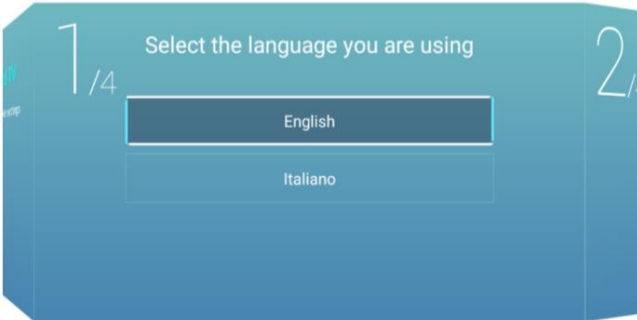
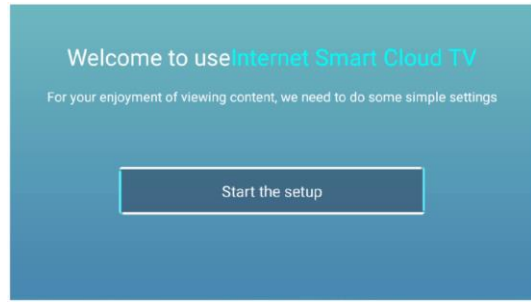

Use the ▼ and ▲ buttons to select the language. Press the OK button to select the highlighted language before pressing the ► button to move to the next screen.

Use the ▼ and ▲ buttons to select the time zone in which the TV is being installed. Press the OK button to select the highlighted time zone before pressing the ► button to move to the next screen.

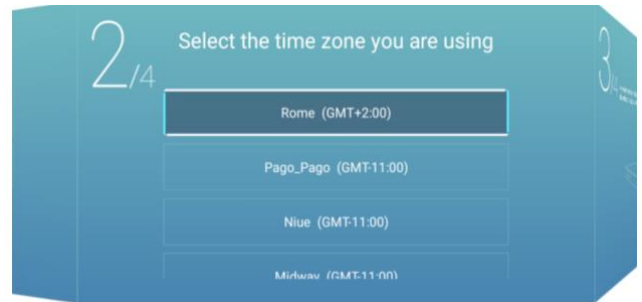

Press the OK button to connect the WIFI/wired network. If connecting to a wireless network, select your router, and enter the router password. Press the ► button to move to the next screen.

Use your mobile phone to scan the 2D code to connect the TV Assistant. (Refer to Eshare document for details)



Your Tv is now ready to use, chose the initial input using the remote navigation.

BASIC OPERATION

STANDBY MODE

- Press the STANDBY button to turn on the television.
- Press the STANDBY button again to return the television to standby mode. The power indicator will turn red.
- Be sure not to set your TV in standby mode for a long period of time.

MAIN MENU

Press the MENU button to enter the main menu for the TV. This is split into 6 separate sections Use the ◀ and ▶ button to select the required section before using the ▼ or ▲ button to enter it.

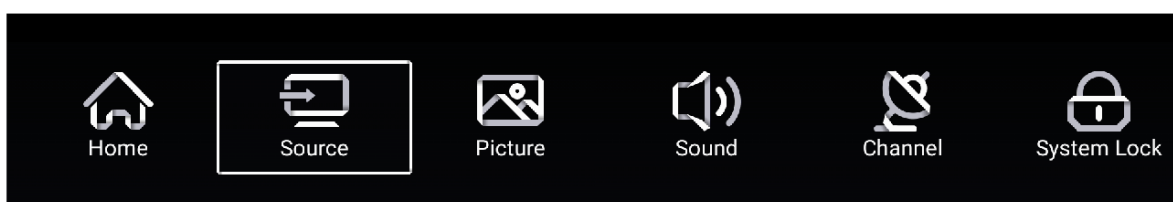

HOME

The home section provides you with options to change the current input source, as well as giving access to the smart functions within the TV. Use the arrow buttons on the remote to navigate the screen, or alternatively press the MOUSE button on the remote to activate the mouse cursor.



APPS

Provides links to the App Store to download apps to your SMART TV. The applications button can also be selected to view all currently installed Apps. Press and hold the “OK” button on the remote when the app is highlighted to delete or re-arrange apps.

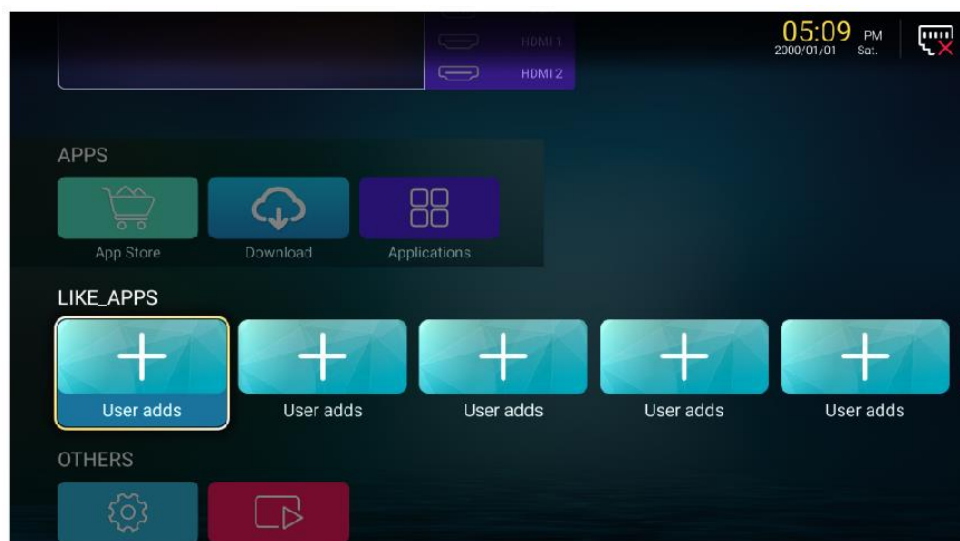

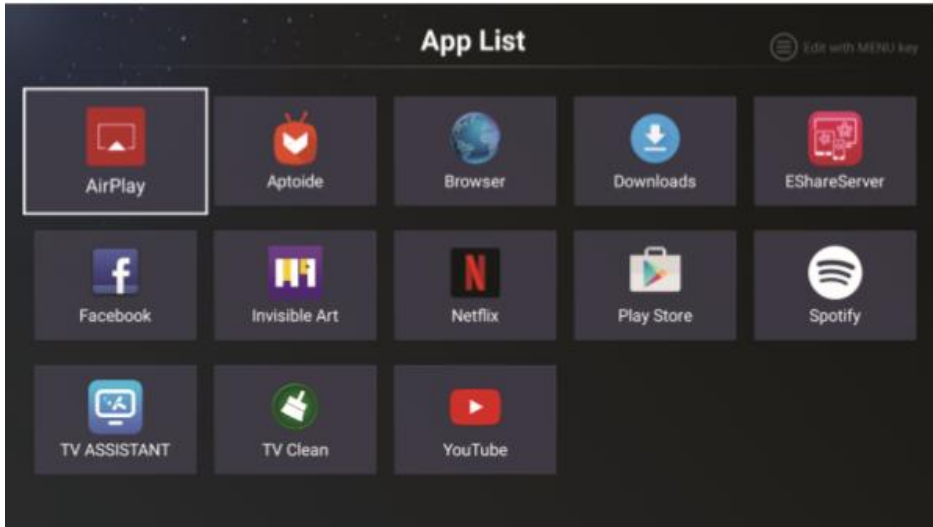

APPLICATIONS / APP List

Within the App List, select the APP to open and press the OK button to launch the application.

LIKE_APPS

This provides quick links to your most commonly used APPS. To add an app to your LIKE_APPS list, select a User Adds button, and then select the App to add from the list of installed apps provided.

SETTINGS

This provides access to the settings for the SMART component of the TV, providing options to update your WIFI connection

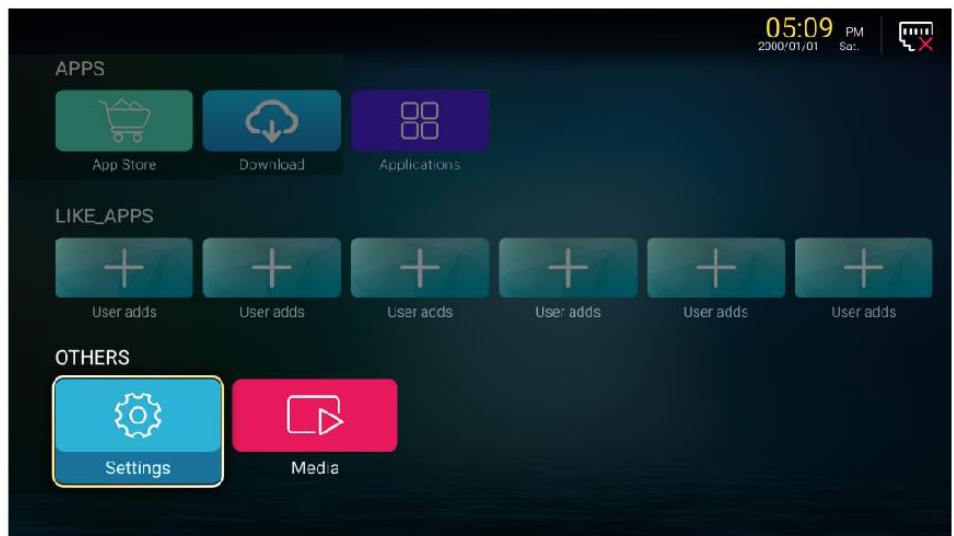





MEDIA

Media allows the playback of videos and music, and the viewing of pictures saved on the TV or memory stick.

VIDEO

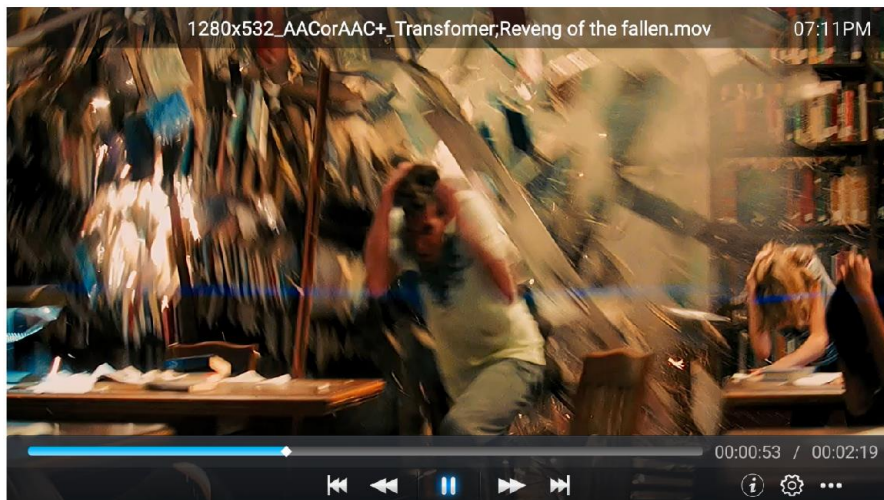
Use the ◀ and ▶ buttons to select the video to play.





 Press to play previous video.

 Press to play fast backward.

 Press to stop/play the video.

 Press to play fast forward.

 Press to play the next video.

 Press to view the information for the video (Resolution/Size/Duration/Bitrate)

 Press to set the Audio Track/Select Subtitle/Region Language/Play Mode/Aspect Ratio.

 Press to select the video to play.

MUSIC

Use the ◀ and ▶ buttons to select the video to play.



Press to play fast backward.



Press to stop/play the music.



Press to play fast forward.



Press to view the information for the music. (Mine Type/Size/Bitrate)



Press to set the Play Mode (Repeat All/Repeat One/Random/None).



Press to select the music to play.

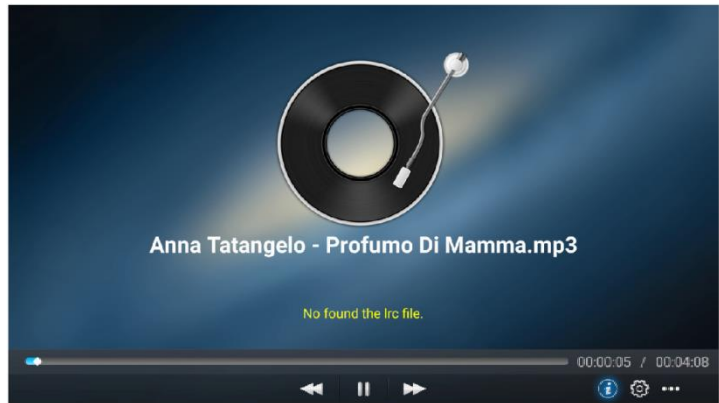

PHOTO

Press ◀ / ▶ to select photo.



Press to rotate the picture anticlockwise.



Press to stop/play the slideshow.



Press to rotate the picture clockwise.



Press to view the information for the picture. (Size/Resolution)



Press to set the Play Mode (Aspect Ratio/Playback duration).



Press to select the photo to display.

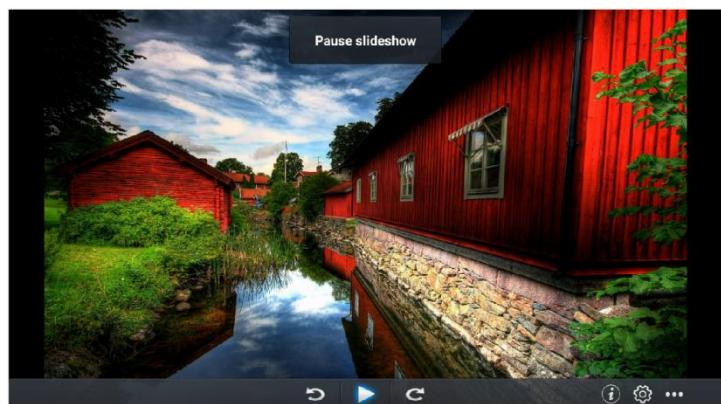



SELECT THE INPUT SOURCE

THROUGH THE MAIN MENU

Select source to show the input source list and use the ▲ and ▼ buttons to select the input.

Press the ENTER button on the remote to confirm

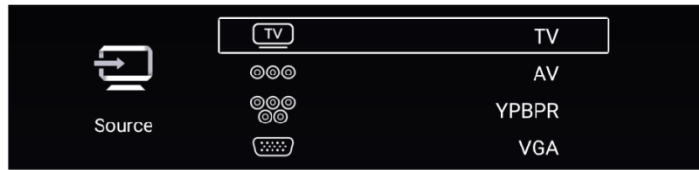

USING THE REMOTE:

Press the SOURCE button to display the input source list.

Use the ▲ and ▼ buttons to select the input.

Press the ENTER button on the remote to confirm

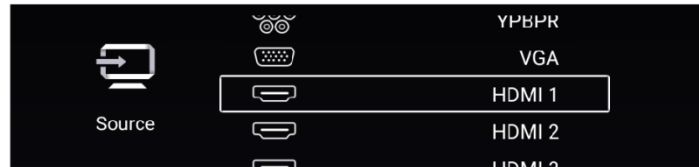

USING THE TV CONTROLS:

Press the SOURCE button repeatedly to scroll through the input source list



PICTURE

The Picture section provides you with the options to change the picture settings, allowing you to modify the display based on its location and your personal preferences.

Navigate the picture section using the ▼ and ▲ buttons, and select or modify the selected line using the ◀ and ▶ buttons: Within this section you can make changes to the: Picture Mode/Contrast/Brightness/Colour/Sharpness/Backlight/Noise Reduction/Colour Temp/More Settings

PICTURE MODE

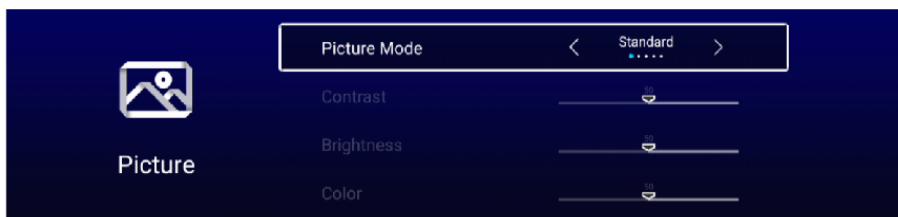

Can be changed between Standard, Movie, Vivid, Energy Saving, User.

Standard	The default mode, to make users experience high-quality images under normal light.
Movie	This mode is more suitable for watching movies.
Vivid	Image colours more beautiful, more vivid picture.
Energy Saving	Reduce screen brightness, improved contrast for energy saving.
User	User-defined picture settings.

CONTRAST/ BRIGHTNESS/ COLOUR/ SHARPNESS/ BACKLIGHT



Contrast	Adjust image contrast.
Brightness	Adjust image brightness.
Colour	Adjust image colour density.
Sharpness	Adjust the image edge sharpness.
Backlight	Adjust the screen backlight brightness

NOISE REDUCTION

Used to eliminate image noise intensity between the option of: Off, Low, Medium, High, Auto

COLOR TEMP

Adjust the overall colour of the image between the following options

Cool	Produces a gentle blue-hued image.
Normal	Produces a vivid image.
Warm	Produces a red-hued image.

MORE SETTINGS

More settings contain the option to adjust the DLC settings.

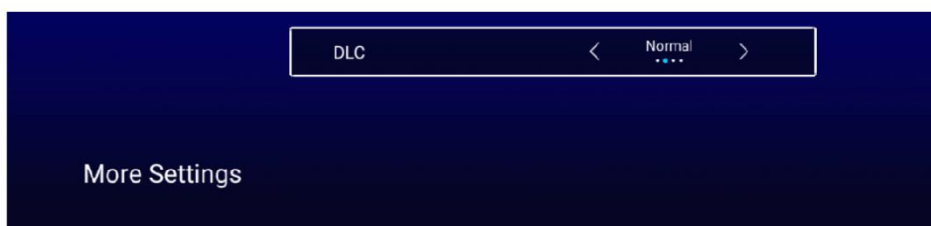

DLC (Dynamic light control)

Can be changed between the options of select Dark/Normal/Bright/Off.

SOUND

The Sound section provides you with the options to change the sound settings, allowing you to modify the output based on your personal preferences.

Navigate the picture section using the ▼ and ▲ buttons, and select or modify the selected line using the ◀ and ▶ buttons: Within this section you can make changes to the: Sound Mode/ Bass/ Treble/ Balance/ AVC/ More settings.

SOUND MODE



Can be changed between: Standard, Music, Theatre, News and User.

Standard	Produces a balanced sound in all environments.	
Music	Preserves the original sound. Good for musical programs.	
Theatre	Enhances treble and bass for a rich sound experience.	
News	Enhanced voice.	
User	Select to customize picture settings.	
	Bass	Adjust the bass.
	Treble	Adjust the treble.
	Balance	Adjust the left and right channel output balance.

AVC

After turning on the AVC, the TV will reduce the impact of difference in the transmission volume of broadcasts, helping to ensure the volume is stable when changing channels.

MORE SETTINGS



SPDIF

Choose between the option of OFF/RAW/PCM.

SPDIF DELAY

Used to adjust the delay time on the SPDIF output.

SURROUND

Use to turn the Surround option On and Off.

AUDIO ONLY

This option will turn off the screen output and only play the sound from the input selected.

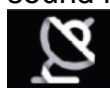
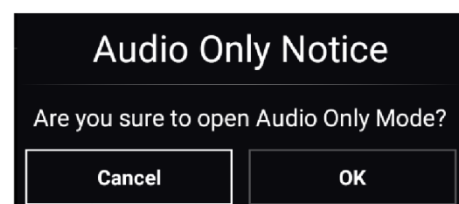

CHANNEL

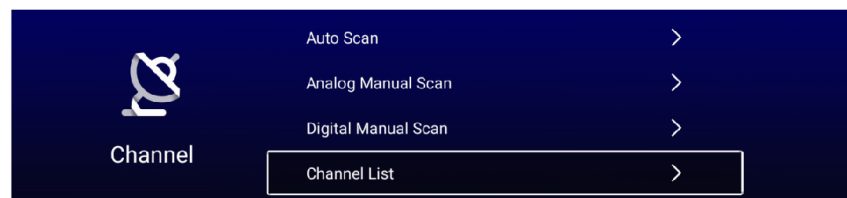
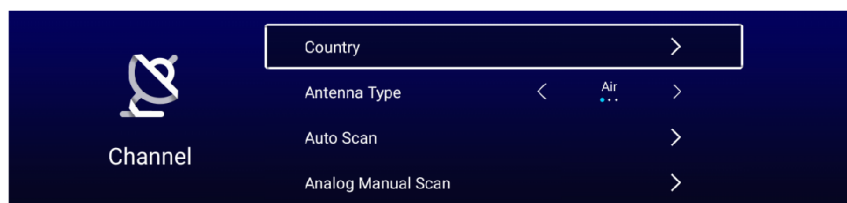

COUNTRY

Allows the country to be changed from the country selected during the initial setup.

ANTENNA TYPE-AIR

Select the Type of input on the RF connection between a standard aerial and cable.

AUTO SCAN

Use to automatically scan for channels

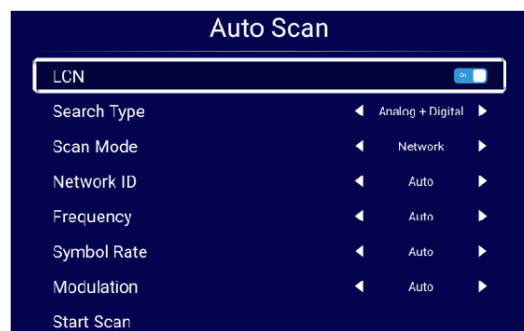

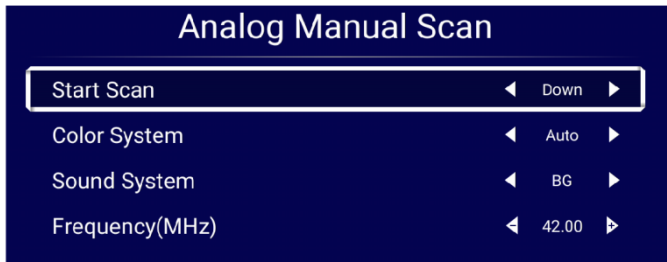

ANALOG MANUAL SCAN

The TV will scan for Analogue channels that are broadcast

DIGITAL MANUAL SCAN

The TV will scan for Digital channels that are broadcast

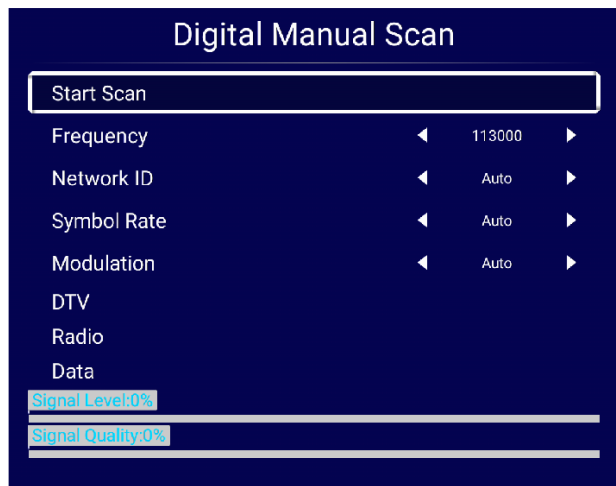

CHANNEL LIST

Press the MENU button edit the channel (Skip /Delete /Fav).

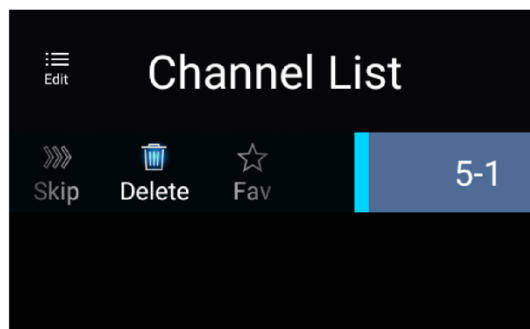

EPG (Electronic Program Guide)







The electronic program guide allows you to browse the channels, and view the current and upcoming programs.

EPG OPERATIONS



In the EPG menu, you will have three options (Shown above), these options control the functions of live TV.

	<p>By pressing the RED button, you will be able to record the programme you are watching (if an external USB or hard drive is connected).</p> <p> Press this button on the remote to stop recording and to exit EPG mode.</p>
	<p>By pressing the YELLOW button, you can view your recording schedule</p>
	<p>The Blue button is used to set a reminder when a TV programme will be recorded</p>

SYSTEM LOCK

The system lock allows you to set both a system lock and a keypad lock for the remote. It also creates a password to administer it.

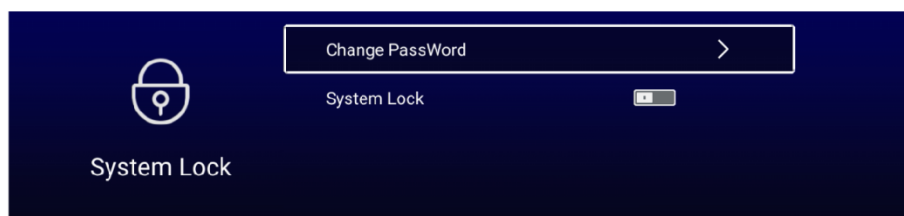

CHANGE PASSWORD

Enter the old password (If set) and the new password twice to set up a password of the system lock.

SYSTEM LOCK

Allows the system lock to be turned On/Off

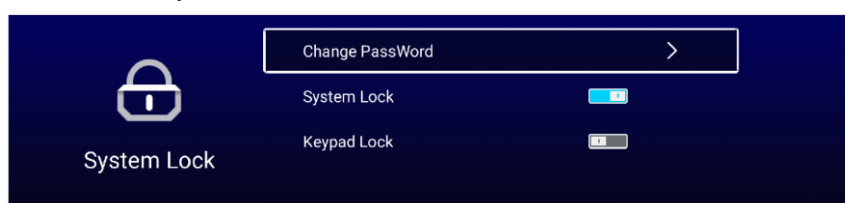

KEYPAD LOCK

Allows the keypad lock to be turned On/Off
(NOTE: This function is only available when the System Lock is on).



TIME SETTING

The Time Setting section provides you with the options to change the Time settings.

Navigate the Time Setting section using the ▼ and ▲ buttons, and select or modify the selected line using the ◀ and ▶ buttons: Within this section you can make changes to the: OSD Timer/Sleep Timer/Auto standby Timer



OSD TIMER

Can be changed between: off,5sec,15sec,30sec.

SLEEP TIMER

Can be changed between: off,15min,30min,45min,60min,90min,120min,240min.

AUTOSTANDBY TIMER

Can be changed between: off,3hour,4hour,5hour.



COMMON

Navigate the Common section using the ▼ and ▲ buttons, and select or modify the selected line using the ◀ and ▶ buttons: Within this section you can make changes to the: Blue Screen/HDMI CEC/Menu Reset

PVR SETTING

Use to select the recording location for the PVR.

BLUE SCREEN

Used to turn blue screen On and Off when the current channel is not receiving a broadcast.

HDMI CEC

Turn the HDMI control On and Off.

MENU RESET

Use this option to return all the settings within the TV menu back to the factory default.

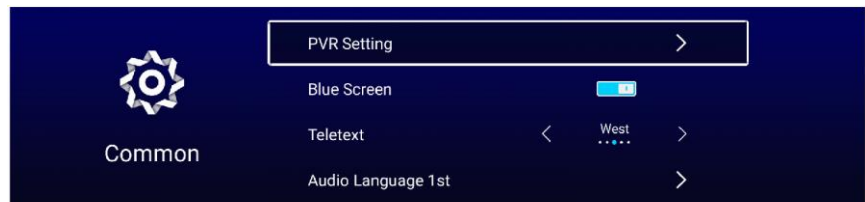

TECHNICAL SPECIFICATION

Product Model		eiQ-32HDT2SM
Screen Size		32" Diagonal
Aspect Ratio		16:9
Power Supply		AC 100-240V, 50/60Hz
Power Consumption		65W
TV System		PAL DVB-T2/T/-C (There is no DVB-C signal in some Countries or Areas.)
Picture	Maximum Resolution	1366x768
	Brightness	200 cd/m ²
	Static Contrast	4000:1
	Response time	8ms
Input Terminal	Antenna Input	X1
	USB Input	X2
	HDMI Input	X3
	VGA Input	X1
	PC AUDIO Input	X1
	Audio Input (L/R)	X1 (Mini AV)
	Video Input	X1 (Mini AV)
	YPbPr Input	X1 (Mini)
	RJ45 Input	X1
	CI card In	X1
	SCART In/Output	X1
	DC In (12V)	NO
	CARD SLOT	NO
Output Terminal	Earphone	X1
	Audio Line Out(L/R)	NO
	Video Output	NO
	Optical	NO
	Coaxial out	X1 (Digital)
Working Temperature		0°C ~40°C
Working Humidity		20% ~ 80% Non-condensing

Due to continued product development the specification shown above may change without notice.

SIMPLE TROUBLESHOOTING

If the display fails or the performance changes dramatically, check the display in accordance with the following instructions. Remember to check the peripherals to pinpoint the source of the failure.

Symptom	Solution
Power cannot be turned on. (Power indicator does not illuminate.)	-Check that both ends of the power cable are plugged into the socket appropriately and the wall socket is operational
No Input Signal message appears.	-Check that the aerial cable is connected properly. -Check that the power of the relevant peripherals is turned on. -Check that the selected source matches the input.
The remote control does not function properly.	-Check the batteries are not drained. (Use new batteries.) -Check that the remote control is within the operating range. -Check that the remote control is pointed to the remote-control window on the display. -Check that there are no obstacles between the remote control and the remote-control window.
Flashing spots or stripes appear on the screen.	-Check that there is no emission (Car, HV cable or Neon lamp) or other possible interference sources.
Image colour or quality deteriorates.	-Check that all the video settings are adjusted appropriately, such as brightness, contrast, colour etc. -For more information about video settings, refer to OSD Functions
Screen position and size are incorrect.	-Check that the screen position and size is adjusted appropriately.
Image or colour is incorrect.	-Check that the signal line is connected properly. -When connecting to a PC, you can change the resolution of the PC to acquire the correct image. The discrepancy of the PC output signal may affect the display of the image.
Display warning message.	-Check that the input signal line is properly fixed. -Select the correct input signal. -For more information, refer to Supported Signal Modes

EU DECLARATION OF CONFORMITY

Hereby, electriQ declares that this television is in compliance with Directive 2014/53/EU. The full text of the EU declaration of conformity is available at the following internet address:

<https://www.electriQ.co.uk/content/declaration-of-conformity>

PRODUCT DISPOSAL



Do not dispose this product as unsorted municipal waste. Collection of such waste must be handled separately as special treatment is necessary.



Recycling facilities are now available for all customers at which you can deposit your old electrical products. Customers will be able to take any old electrical equipment to participating civic amenity sites run by their local councils. Please remember that this equipment will be further handled during the recycling process, so please be considerate when depositing your equipment. Please contact the local council for details of your local household waste recycling centres.

electriQ UK SUPPORT

Complete online support form on:

www.electriQ.co.uk/support

Service Line: 0871 620 1057

Office hours: 9AM - 5PM Monday to Friday

Unit J6, Lowfields Business Park,
Lowfields Way, Elland
West Yorkshire, HX5 9DA