

electric*iq*

49/55/65 inch LED TV



eiq-CV49UHDT2SM

eiq-CV55UHDT2SM

eiq-CV65UHDT2SM

LED TV

CONTENTS

Safety Information.....	3
What's included.....	6
TV Stand Installation/Removal.....	7
Getting Started.....	9
Connecting to External Devices.....	12
Remote Control.....	13
Settings.....	19
Smart TV Setup and Settings.....	52
Troubleshooting	59
Specifications.....	60
Support & Disposal.....	62

SAFETY INFORMATION

- Read these instructions – All the safety and operating instructions should be read before this product is operated.
- Keep these instructions – The safety and operating instructions should be retained for future reference.
- Heed all warnings – All warnings on the appliance and in the operating instructions should be adhered to.
- Follow all instructions – All operating and usage instructions should be followed.
- Do not use this equipment near water – The appliance should not be used near water or moisture e.g. in a wet basement or near a swimming pool.
- Clean only with a dry cloth. Do not use solvents or petroleum based fluids.
- Do not block any ventilation openings.
- Do not install near any heat sources such as radiators, stoves or other apparatus (including amplifiers) that produce heat.
- Do not tamper with the supplied plug. This plug is a BS1363 standard plug.
- Protect the power cord from being walked on or pinched, particularly at the plug and at the point where they exit from the appliance.
- Only use attachments/accessories specified by the manufacturer.
- Use only with a cart, stand, tripod, bracket or table specified by the manufacturer or sold with the apparatus. When a cart or stand is used, use caution when moving it to avoid any injuries or damage from it tipping over.

- Unplug the apparatus during lightning storms or when unused for long periods of time.
- Refer all servicing to qualified personnel. Servicing is required when the apparatus has been damaged in any way, such as power supply cord or plug is damaged, liquid has been spilled or objects have fallen into the apparatus or it has been exposed to rain or moisture, it does not operate normally or has been dropped.
- Please keep the unit in a well-ventilated environment.
- The TV set should only be connected to a mains power supply with 220-240V 50Hz
- To prevent overload, do not share the same power supply socket with too many other electronic components.
- Do not place any connecting wires where they may be stepped on or tripped over.
- Do not place heavy items on the cable as this may cause damage.
- Hold the main plug, not the wires, when removing from a socket.
- Pull the plug out immediately and seek professional help if the main plug or cable is damaged, liquid has spilt onto the set, if accidentally exposed to water or moisture, if anything accidentally penetrates the ventilation slots or if the set does not work normally.
- Do not remove the safety covers. There are no user serviceable parts inside. Trying to service the unit yourself is dangerous and may invalidate the product's warranty. Only qualified personnel should service this apparatus.

- To avoid battery leakage, remove exhausted batteries from the remote control when not in use for a long period.
- Do not block ventilation slots on the back cover. The TV can be placed in a cabinet but ensure at least 5cm (2”) clearance all around.
- Do not tap or shake the TV screen, this may damage internal components.
- **WARNING:** To reduce the risk of fire or electric shock, do not expose this apparatus to rain or moisture. The apparatus shall not be exposed to dripping or splashing and objects filled with liquids, such as vases, shall not be placed on the apparatus.
- **WARNING:** The wall plug socket is used as a disconnection device and should remain readily accessible.
- **WARNING:** The batteries shall not be exposed to excessive heat such as direct sunlight or fire.



This warning sign is to warn of dangerous voltage inside the product.

CAUTION
RISK OF ELECTRIC SHOCK
DO NOT OPEN

CAUTION: To reduce the risk of electric shock, DO NOT remove the cover (or back). No user serviceable parts inside. Refer servicing to qualified service personnel.



This warning sign is to alert you of important instructions accompanying the product.

This equipment is a Class II or double insulated electrical appliance. It does not require a grounded connection.

AT FULL VOLUME, PROLONGED LISTENING MAY DAMAGE THE USER’S HEARING.



WHAT'S INCLUDED



TV Set



Remote Control (2xAAA batteries)

Base Stand

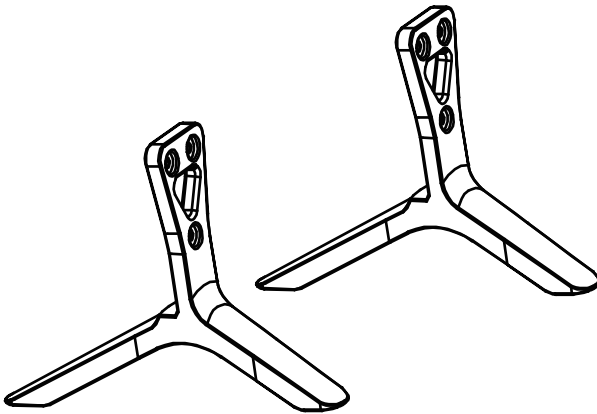

User Manual

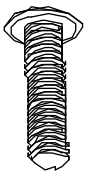

6 Screws

TV STAND INSTALLATION/REMOVAL

49 Inch (eiq-CV49UHDT2SM)

55 Inch (eiq-CV55UHDT2SM)

65 Inch (eiq-CV65UHDT2SM)

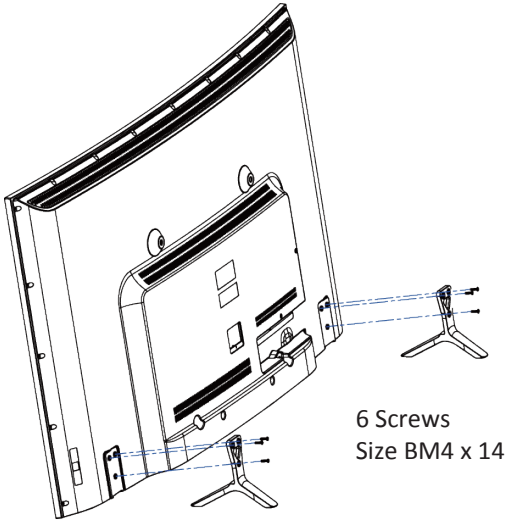

6 Screws
Size BM4 x 14

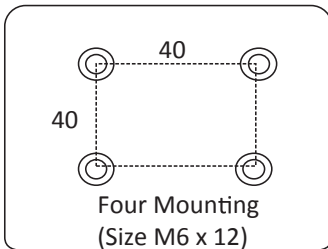

WALL MOUNTING

- The TV is provided with mounting holes for a VESA approved wall mounting bracket (not supplied)
- The VESA mounting pattern is:
 - 49/55/65Inch - 400x400mm and the size of the screws is 4 x M6 x 12 (not supplied)
- Do not use screws longer than 12mm or damage will occur to the internal components.

NOTE: As the TV set is considered heavy, please consult with a professional wall mount installer to perform the installation.

GETTING STARTED

BUTTON FUNCTIONS

1. **MENU** Button: To enter menu setting page.

2. **CH+**: To select next channel

3. **CH-**: To select previous channel

4. **VOL+**: To increase the volume level

5. **VOL-**: To decrease the volume level.

6. **SOURCE** Button: To select the input source.

7. **STANDBY** BUTON: To turn ON/OFF the TV

8. Remote Control Sensor

9. **Power Indicator**: In standby mode the indicator light will display red, when switching on the unit the indicator light will display green.

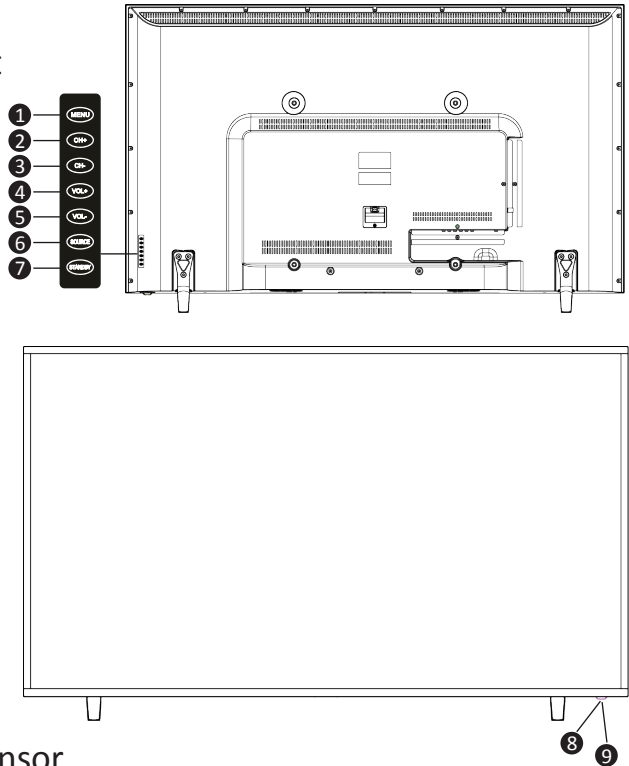

INPUT / OUTPUT TERMINALS

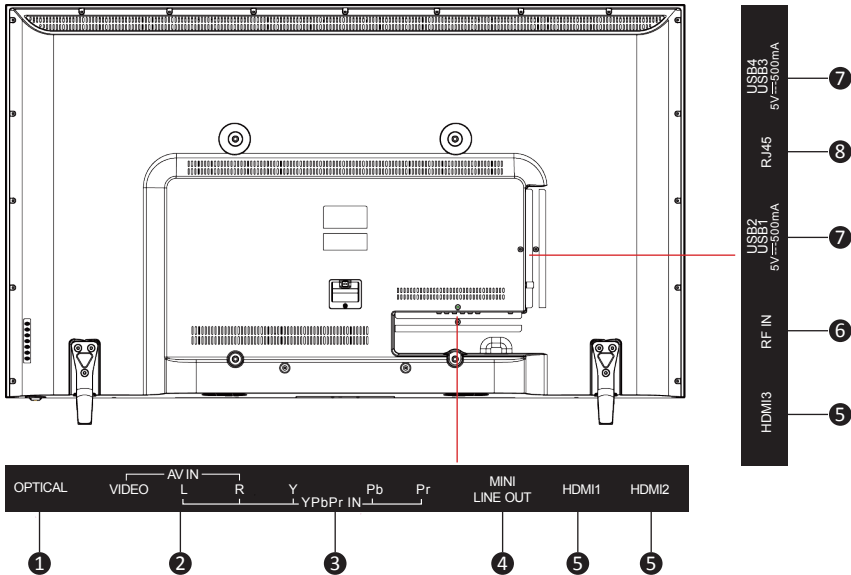

1. OPTICAL terminal
2. AV input terminal
3. YPbPr: Connect to the YPbPr video output terminal of the DVD player
4. Mini Audio Line output terminal
5. HDMI x3
6. RF: Antenna connection

7. Side USB3/4. Provides access to SMART TV. Connect smart remotes, keyboards, gaming accessories or usb flash drive
Side USB1/2 can be used for DTV recording, timeshift or as a media player file.
Note: only connect low power USB flash drives or externally powered hard drives to the 4x USB ports as they only provide 0.5 Amps power
8. RJ45: **Smart TV** Ethernet connection can be used instead of WIFI connection

CONNECTING TO EXTERNAL DEVICES

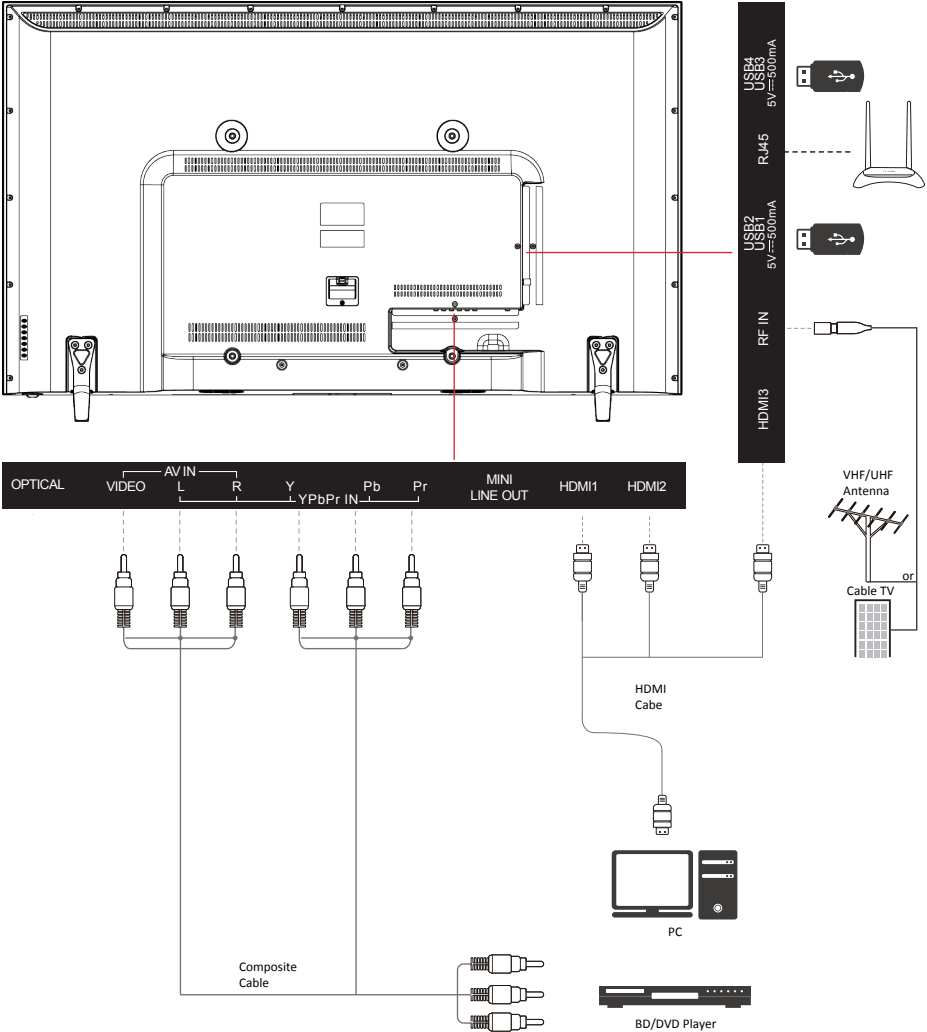

REMOTE CONTROL

1. **STANDBY:** Turn on the TV/Standby
2. **SOURCE:** Press to change the signal source
3. **SEARCH (SMART TV)**
 - **GREEN** Button TXT EPG
4. **REFRESH (SMART TV)**
 - **YELLOW** Button TXT EPG
5. **HOME (SMART TV)**
 - **RED** Button TXT EPG
6. **MOUSE (SMART TV)**
 - **BLUE** Button TXT EPG
7. **S. MODE:** Setting audio options
8. **FREEZE:** Freeze the picture
9. **P. MODE:** Output image/picture mode selection
10. **MENU:**Show Menu
TXT:Turn on and off the Teletext function
11. **FAV.LIST:** Show the list of favourite channels
MIX:Setting transparency
12. **RECORD:**In DTV mode, press REC button to start recording, press ■ button stop recording.

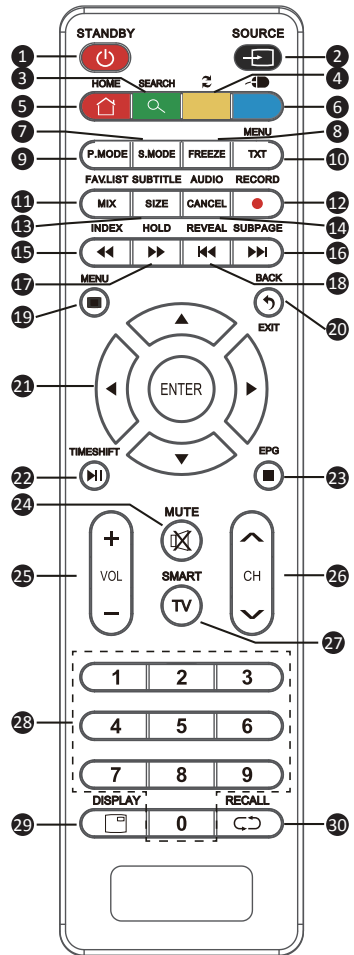

13. SUBTITLE: Select subtitle of media video file (requires the support of disk or file)
P. SIZE: Press to select the different picture size.
14. AUDIO: Switch the audio channel when DVD or multimedia playing.
CANCEL:Cancel the TXT on screen
15. INDEX:Display the index page
◀◀:Rewind playback
16. SUBPAGE:Enter the sub page mode
▶▶:Next file or chapter
17. HOLD:Hold the current page
▶▶ :Fast Forward playback
18. REVEAL:Reveal the hidden information
◀◀:Previous file or chapter
19. MENU:Enter or exit menu
INFO: Show information about the current program
20. EXIT: Exit the Menu
21. NAVIGATION KEYS (Up, Down, Left, Right and ENTER): To move in the menus and confirm settings. Also in smart mode used for navigation or scrolling (with mouse disabled)
22. TIME SHIFT: In DTV mode, press TIME SHIFT button to start the delay function, press the ▶II button to start playing delay program, press the ■ button to terminate the delay function.
▶II :Play/Pause

23. EPG:Enter or exit EPG(Electronic Program.Guide)
 - :Stop Playback
24. MUTE: Mute or restore the sound
25. VOL+/-: Increase / decrease volume
26. CH+/-: Next / previous channel
27. **SMART**:Provides quick access to the smart TV functions
press again (TV) to return to DTV mode
28. NUMBER KEYS: Change the channel
29. DISPLAY:Displays the main index in TELETEXT mode.
30. RECALL:Return to the previous selected channel

SMART CONTROLS

when the TV is in smart mode the following keys are activating android navigations functions

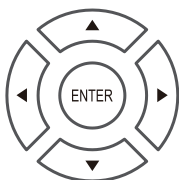

Use arrows to navigate the smart TV menu and ENTER key to select. Basic navigation and text input can be done via those keys. Certain functions will required virtual remote or the optional all-in-one advanced remote. While mouse emulation is off the arrow keys deliver basic scrolling.

 **MENU** contextual menu and options

 **BACK** key navigation

 Turns on / off the mouse emulation. Use the arrows to navigate and OK to select. To return to keys navigation press mouse key again.

 **SEARCH** function enable quick text search



HOME function returns to the main SMARTTV menu

The smart navigation on standard TV remote control provides basic Smart TV navigation and flawless Kodi operation.

How to use mouse emulation button from remote: Press the yellow **MOUSE** key. You will get an arrow cursor on the screen. Press the arrow keys to control the cursor up/down/right/left. Use “**ENTER**” button to confirm as left mouse click. Use “**Back**” button to confirm as right mouse click.

For an enhanced experience, when you play games or operating other complex apps we recommend using virtual smart phone remotes or the optional extended gyroscopic all-in-one remote with keyboard. If using a hardware standard USB mouse the following functions are mapped: Left click – confirm; Right click – Back navigation; mouse wheel: scroll, page up and down; Middle click – Menu.

BATTERY INSTALLATION

1. Open the battery cover.
2. Insert 2 AAA batteries in the battery compartment, matching the polarities correctly.
3. Replace the battery cover.

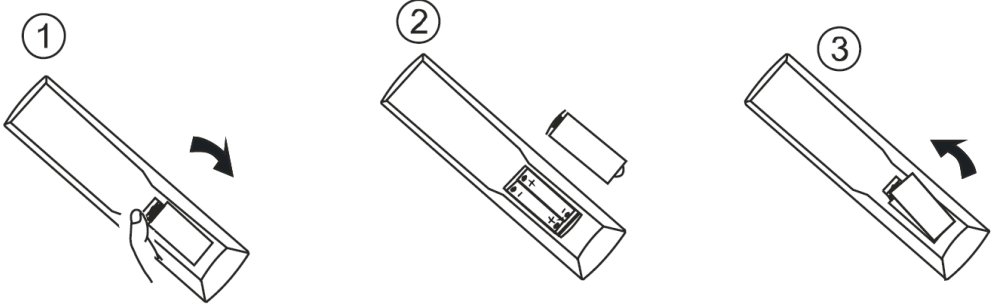

SETTINGS

INITIAL SETUP



1. Connect the TV set to a power outlet.
2. Press the POWER button on the remote or on the TV set to turn on the TV (the indicator will be lit green)

NOTE: Pressing the power button on the remote or TV set will place the TV into standby mode only. If the TV set is expected to be not in use for a long period of time, please disconnect it from the power source.

SELECT INPUT SOURCE



Press INPUT button to display the input source list

Press ▼ / ▲ or OK button to select the input source you want to

Press OK button to enter the input source

Press EXIT button to quit.

First Time Installation

Connect an RF cable from the Tv's input called "RF-In" and to your TV Aerial socket.

Select Language

Press ◀ / ▶ button to select the language to be used for menus and message.

Select Country

Press ▼ / ▲ button to highlight country menu.

Press ◀ / ▶ button to select the country you want to.

Auto Tuning



First tuning ATV, press Menu and left arrow button to skip ATV tuning, Second tuning DTV, press Menu and left arrow button to skip DTV tuning.

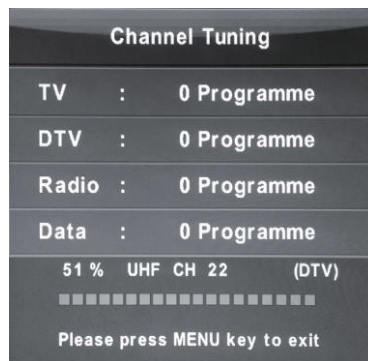

Main Menu Operation

Channel Menu

Press MENU button to display the main menu.

Press ◀ / ▶ button to select CHANNEL in the main menu.



1. Press ▼ / ▲ button to select the option that you want to adjust in the CHANNEL menu.
2. Press Enter button to adjust.
3. After finishing your adjustment, Press Enter button to save and return to the previous menu.

Auto Tuning

Press ▼ / ▲ button to select Auto Tuning, then press Enter/▶ button to enter.

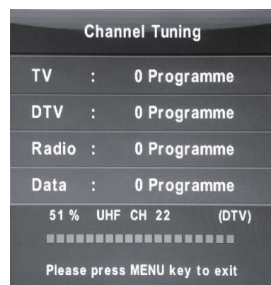
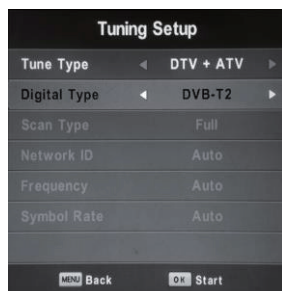

ATV Manual Tuning

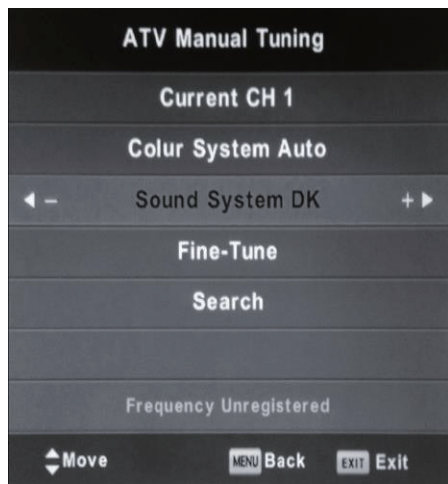

Current CH

Set the channel number.

Colour System

Select the colour system

Sound System

Select the Sound system

Fine-Tune

Adjust the frequency of the channel finely.

(Available System: AUTO, PAL, SECAM)

Search

Start searching channel

DTV Manual Tuning

Press ▼ / ▲ button to select DTV Manual Tuning, then press Enter button to enter sub-menu.

Press ◀ / ▶ button to select channel, then press Enter button to search program.



Program Edit



Press ▼ / ▲ button to select Programme Edit, then press Enter button to enter sub-menu.



The three coloured keys are the shortcut keys for programming the channel.

First press ▼ / ▲ to highlight the channel you want to select, then: Press the Red button to delete the program in the list. Press the Yellow button to move the channel in favorite list. Press the Blue button to skip the selected channel.

Press Fav button to add or remove the channel to your favorite list. (Your TV set will skip the channel automatically when using

CH+/- to view the channels.)

Schedule List

Press ▼ / ▲ button to select Schedule List, then press Enter button to enter sub-menu. It is available in source.

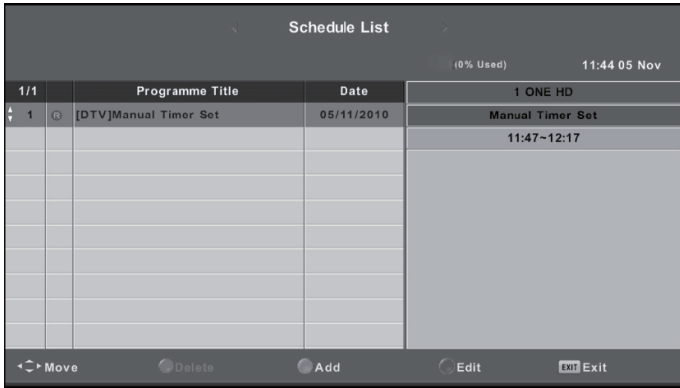

Press the YELLOW button to enter the interface below.

When the time scheduled is in conflict with other event, it will produce a warning message.



Signal Information

Signal Information	
Channel: 25 (506.00MHz)	
Network Digita Finland	
Modulation 256QAM	
Quality 100	(Good)
Strength 75	(Strong)

Press ▼ / ▲ button to select Signal Information, press the Enter button to see the detail information about the signal. Only available when there is signal in DTV.

Picture Menu

Press MENU button to display the main menu.

Press ◀ / ▶ button to select PICTURE in the main menu.

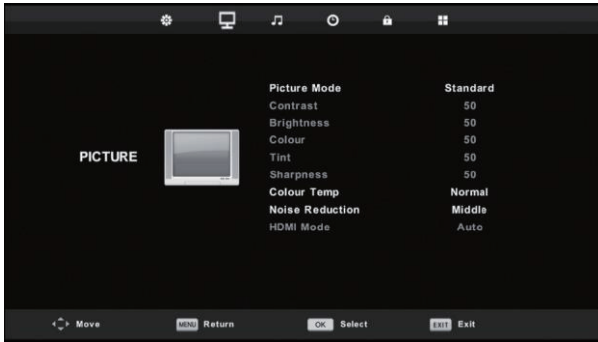

1. Press ▼ / ▲ button to select the option that you want to adjust in the PICTURE menu.
2. Press OK button to adjust.
3. After finishing your adjustment, Press MENU button to save and return back to the previous menu.

Picture Mode

Press ▼ / ▲ button to select Picture Mode, then press OK button to enter sub-menu. You can change the value of contrast, brightness, colour, sharpness and tint when the picture is in Personal mode.

TIPS: You can press PMODE button to change the Picture Mode directly.

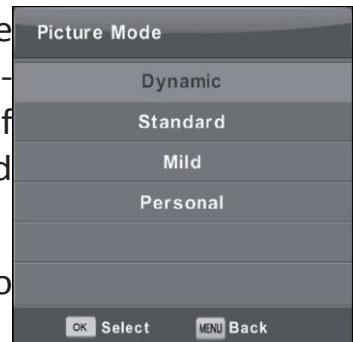

Contrast/ Brightness/ Colour/ Tint / Sharpness

Press ▼ / ▲ button to select option, then press ◀ / ▶ button to adjust.

Contrast Adjust the highlight intensity of the picture, but the shadow of the picture is invariable.

Brightness Adjust the optical fiber output of the entire picture, it will effect the dark region of the picture.

Colour Adjust the saturation of the colour based on your own like.

Tint Use in compensating colour changed with the transmission in the NTSC code.

Sharpness Adjust the sharpness in the detail of the picture.

Colour Temp

Press ▼ / ▲ button to select Colour Temperature , then press OK button to enter sub-menu. Press ◀ / ▶ button to select. (Available Picture mode: Cool, Medium, Warm).

You can change the value of red, green and blue when the colour temperature is in User mode

Cold Increases the blue tone or the white. **Normal** Set to default colour temperature. **Warm** increases the red colour for the white.

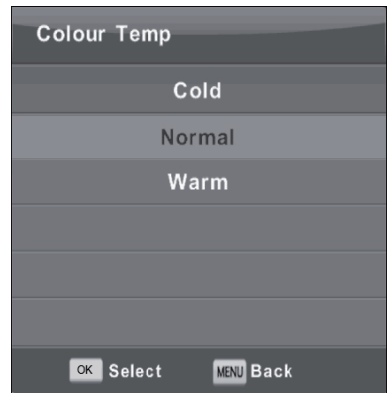

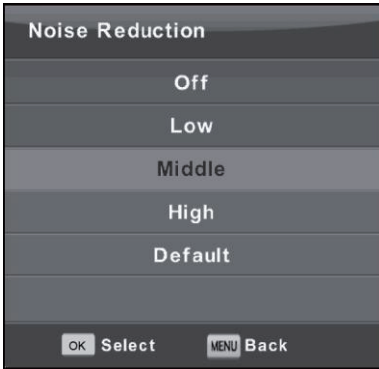

Noise Reduction

To filter out and reduces the image noise and improve picture quality. Press ▼ / ▲ button to select Noise reduction, then press OK button to enter sub-menu

Off Select to turn off video noise detection.
Low Detect and reduce low video noise. **Middle** Detect and reduce moderate video noise. **High** Detect and reduce enhanced video noise. **Default** set as Default.

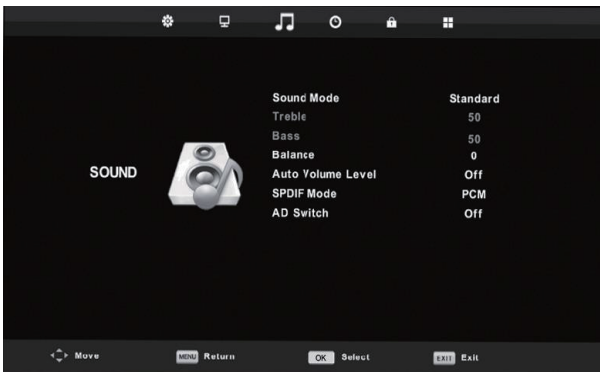

Sound Menu

1. Press ▼ / ▲ button to select the option that you want to adjust in the SOUND menu.
2. Press Enter button to adjust.
3. After finishing your adjustment, Press Enter button to save and return to the previous menu.

Sound Mode

Press ▼ / ▲ button to select Sound Mode, then press Enter button to enter sub-menu. Press ▼ / ▲ button to select.

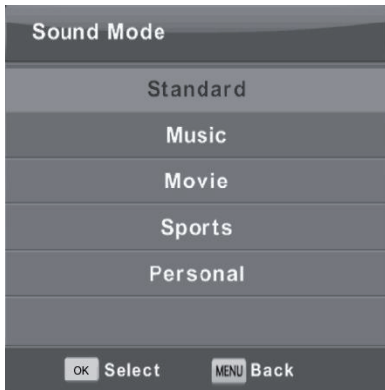

You can change the value of Treble and Bass when the sound is in Personal mode. TIPS: You can press SMODE button on the remote control to change the Sound Mode directly.

Standard Produces a balanced sound in all environments.

Music Preserves the original sound. Good for musical programs.

Movie Enhances treble and bass for a rich sound experience.

Sports Enhances vocals for sports.

Personal Select to customize sound settings.

Note :The treble and bass are only available in User mode,you can adjust them as you like.

Balance

Press ▼ / ▲ button to select option, Press ◀ / ▶ button to adjust.

You can change the value of Treble and Bass when the sound is in Personal mode. TIPS: You can press SMODE button on the remote control to change the Sound Mode directly.

Auto Volume level

Press ▼ / ▲ button to select Auto Volume Level, then press ◀ / ▶ button to select On or Off.

SPDIF Mode

Press ▼ / ▲ button to select SPDIF Mode, then press ◀ / ▶ button to select Off / PCM / Auto.

AD Switch

Press ▼ / ▲ button to select AD Switch, then press ◀ / ▶ button to select On or Off. Amblyopia function for the blind, the tracks will be mixed describe the current screen . It need code stream to support.

NOTE:

Balance: This item can adjust the speaker's output, it enables you to listen to best at your position.

Auto Volume: This item is used for reducing the difference between channel and program's volume automatically.

Time Menu

Press MENU button to display the main menu .

Press ◀ / ▶ button to select TIME in the main menu.



1. Press ▼ / ▲ button to select the option that you want to adjust in the TIME menu.
2. Press Enter button I to adjust.
3. After finishing your adjustment, Press Enter button to save and return to the previous menu.

Time Zone

Press ▼ / ▲ button to select Sleep Timer, then press Enter button to enter sub-menu.



Press ▼ / ▲ / ◀ / ▶ button to select time zone.

Sleep Timer



Press ▼ / ▲ button to select Sleep Timer, then press Enter button to enter sub-menu. Press ▼ / ▲ button to select.

(Available options are:

Off,15min,30min,45min,60min,90min,120min,240min).

Auto Standby



Press ▼ / ▲ button to select Auto Standby, then press Enter button to enter sub-menu. Press ▼ / ▲ button to select.

Tips: The remote control does not make any operation in the hypothesis time, it will close down automatically. If you do any operation, it will reset the time.

OSD Timer

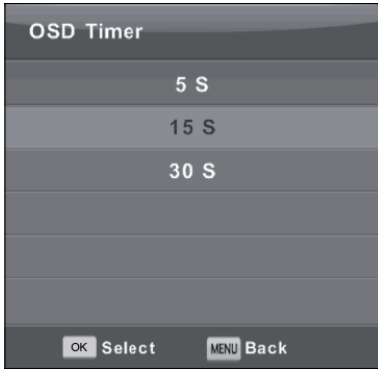

Press ▼ / ▲ button to select OSD Timer, then press Enter button to enter sub-menu. Press ◀ / ▶ button to select.

Lock Menu

Press MENU button to display the main menu.

Press ◀ / ▶ button to select Lock in the main menu.

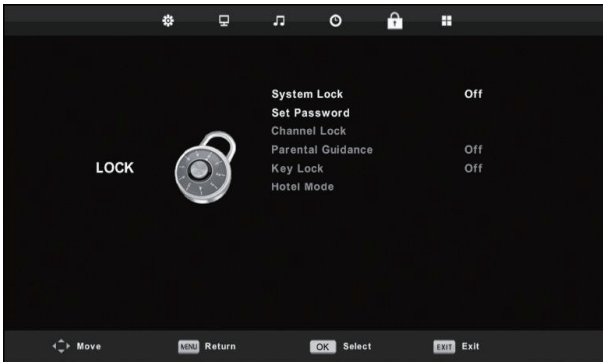

1. Press ▼ / ▲ button to select the option that you want to adjust in the LOCK SYSTEM menu.
2. Press Enter/◀ / ▶ button to adjust.
3. After finishing your adjustment, Press MENU button to return back to the previous menu

Lock System



Press ▼ / ▲ button to select Lock System, then press Enter button to make the following 3 options valid. Default password is 0000

Set Password



Press ▼ / ▲ button to select Set Password, then press Enter button to enter sub-menu to set new password.

Channel Lock



Press ▼ / ▲ button to select Channel Lock then press Enter button to enter sub-menu to select. Press button to lock or unlock the channel Green

Parental Guidance

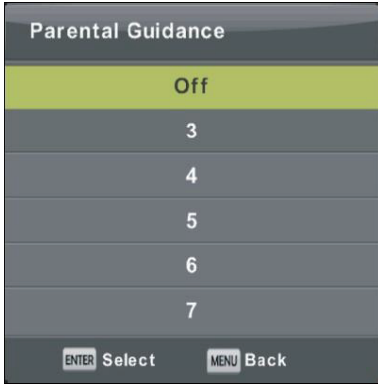

Press ▼ / ▲ button to select Parental Guidance, then press Enter button to enter sub-menu to select the number of age which is suitable for your children.

Key Lock

Press ▼ / ▲ button to select Key Lock, then press ◀ / ▶ button to select Off or On. When Key Lock's statue is on, you can't use the Key panel button.

Hotel Mode



1. Press ▼ / ▲ button on the remote control to select hotel mode in the Lock menu.

2. Press Enter button on the remote control to enter the sub-menu.
3. After finishing your adjustment, Press MENU button to save and return back to the previous menu.

Hotel Mode

Press ▼ / ▲ button to select Hotel Mode, then press ◀ / ▶ button to select on or off.

Source Lock

Press ▼ / ▲ button to select Source lock, then press Enter button to enter sub-menu to select.

Default Source

Press ▼ / ▲ button to select Default Source, then press Enter button to enter sub-menu to select.

Default Prog

Press ▼ / ▲ button to select Default Prog, then press ◀ / ▶ button to adjust. It is available when the default source is TV.

Max Volume

Press ▼ / ▲ button to select Max Volume, then press ◀ / ▶ button to adjust.

Import Database

We can import parameter of Audio/Channel/Lock/Setup from USB disk. Insert USB disk, choose “Import Database” and press enter to import.

Export Database

We can export parameter of Audio/Channel/Lock/Setup to USB disk. Insert USB disk, choose “Export Database ” and press Enter to Export .

Clear Lock

Press ▼ / ▲ button to select Clear Lock, then press Enter button to clear the setting you have done before.

Setup Menu

Press MENU button to display the main menu .

Press ◀ / ▶ button to select SETUP in the main menu.



1. Press ▼ / ▲ button to select the option that you want to adjust in the SETUP menu
2. Press Enter button to adjust.
3. After finishing your adjustment, Press Enter button to save and return to the previous menu.

OSD Language

Select an OSD menu language can be displayed. Default English is selected as menu language.

Press ▼ / ▲ / ◀ / ▶ button to select Menu Language.



TT Language

Press ▼ / ▲ button to select TT Language, then press Enter button to enter sub-menu. Press ▼ / ▲ / ◀ / ▶ button to select TT language.

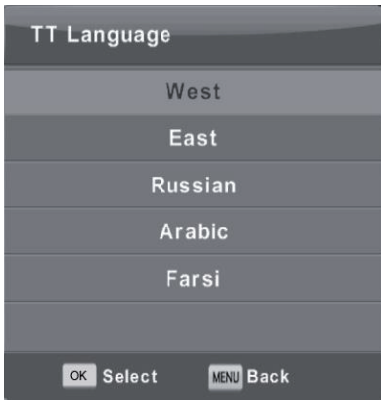

Audio Languages

Press ▼ / ▲ button to select Audio Languages, then press Enter button to enter sub-menu. Press ◀ / ▶ button to select the primary of Audio Languages. Press ▼ / ▲ / ◀ / ▶ button to select the Audio Languages.



Subtitle Language

Press ▼ / ▲ button to select Subtitle Language, then press Enter button to enter sub-menu.

Press ◀ / ▶ button to select the primary of Subtitle Language. Press ▼ / ▲ / ◀ / ▶ button to select the Subtitle Language.



Hearing Impaired

Press ▼ / ▲ button to select Hearing Impaired, then press Enter button to select On or Off.

PVR File System

Press ▼ / ▲ button to select PVR File System, then press Enter button to enter sub-menu. Press ▼ / ▲ button to select Check PVR File System, then press Enter button to enter. Then it will check the USB speed



Aspect Ratio

Press ▼ / ▲ button to select Aspect Ratio, then press Enter button to enter sub-menu. Press ▼ / ▲ button to select aspect ratio. (Available options are: Auto, 4:3,16:9, Zoom1, Zoom2).



Blue Screen

Press ▼ / ▲ button to select Blue Screen, then press Enter button to select On or Off.

First Time Installation

Press ▼ / ▲ button to select First time installation, then press Enter button to enter.

Reset

Press ▼ / ▲ button to select Reset, then press Enter button to enter sub-menu.

Software Update(USB)

Press ▼ / ▲ button to select Software Update (USB), plug your USB device in the USB slot, then press Enter button to update the right software.

HDMI CEC

Press ▼ / ▲ button to select HDMI CEC, then press Enter button to enter the sub-menu.



CEC Control

Press ◀ / ▶ button to turn the CEC Control on or off.

Audio Receiver

Press ◀ / ▶ button to turn the Audio

Receiver on or off.

Device Auto Power Off

Press ◀ / ▶

button to turn the Device Auto Power on or off.

TV Auto Power On

Press ◀ / ▶ button to turn the TV Auto

Power On on or off.

Device List

Press Enter button to show

list of device.

Device Menu Press Enter button to enter the menu of device.

EPG

Press EPG button on remote control to enter EPG menu page.

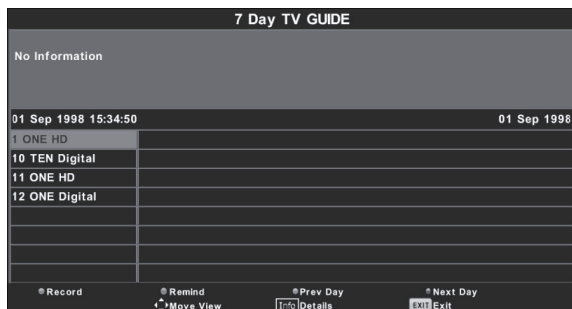

Press UP/DOWN navigation button to select preferred program.

Press LEFT/RIGHT navigation button to switch between left column and right column. When a program is highlighted (cursor moved to Right column):

Press RED button to record program.

Press GREEN button repeatedly to set a reminder.

Press YELLOW button to display program guide of previous day. Press BLUE button to display program guide of next day.



FAVORITE LIST

When viewing an available channel press FAV button on remote control to enter Favorite List menu page.

Press UP or DOWN navigation buttons to select preferred channel.

Press OK button to confirm the selection.

NOTE: To add a favorite channel, please refer to the operations of “DTV Mode > Channel > Programme Edit”

Quick select

When viewing an available channel, press OK button on remote control to enter Channel List menu page.

Press UP or DOWN navigation buttons to select preferred channel.

Press LEFT/RIGHT navigation buttons to select a channel group.



Press OK button to confirm the selection.

Screen Menu

Press MENU button to display the main menu .

Press ◀ / ▶ button to select SCREEN in the main menu.



Press Enter button to start adjusting H-Offset/V-Offset/Size/Phase automatically.

H-Offset

Adjust the horizontal position of the picture.

Press ▼ / ▲ button to select H-Offset, then press Enter button to enter sub-menu.

V-Offset

Adjust the vertical position of the picture.

Press ▼ / ▲ button to select V-Offset, then press Enter button to enter sub-menu

Size

Adjust the display size.

Press ▼ / ▲ button to select Size, then press Enter button to enter sub-menu.

Phase

Adjust the horizontal interfering lines.

Press ▼ / ▲ button to select Phase, then press Enter button to enter sub-menu.

Position Reset

Press ▼ / ▲ button to select Position Reset, then press Enter button to enter.

Media OPERATION

Note: Before operating Media menu, Plug in USB device, then press INPUT button to set the Input Source to Media . Press ▼ / ▲ button to select Media in the Source menu,

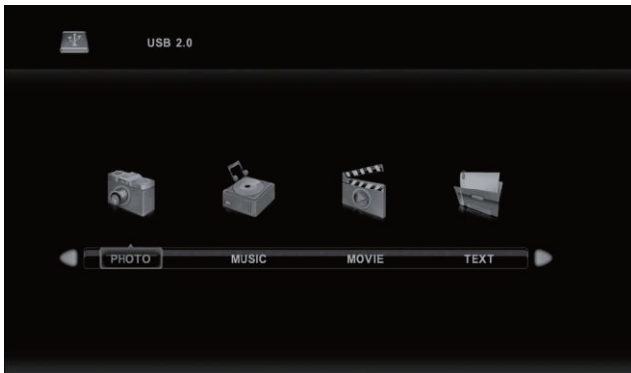

then press Enter button to enter.

Press ◀ / ▶ button to select the option you want to adjust in the main Media menu, Media then press Enter button to enter.

Photo Menu

Press ◀ / ▶ button to select PHOTO in the main menu, then press Enter button to enter. Press Exit button to return to the previous menu and exit menu to quit.

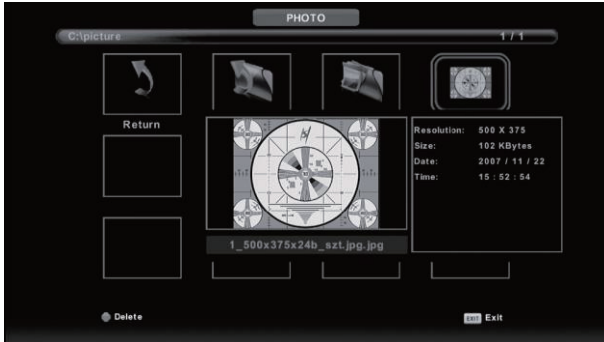

Press ◀ / ▶ button to select the file you want to watch in the file selecting menu, then press media button to display picture.

When highlighting the option you select, the file information will appear on the right and picture will be previewed in the center.

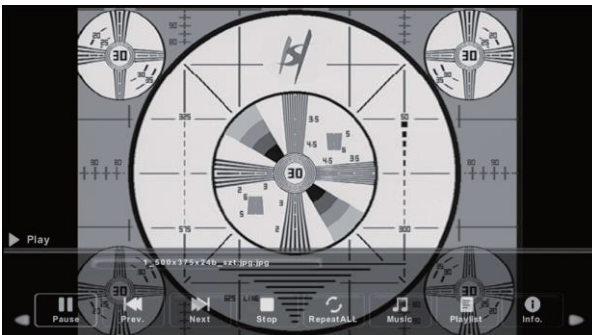

Music Menu

Press ◀/▶ button to select MUSIC in the main menu, then press Enter button to enter. Press Exit button to return to the previous menu and exit menu to quit.

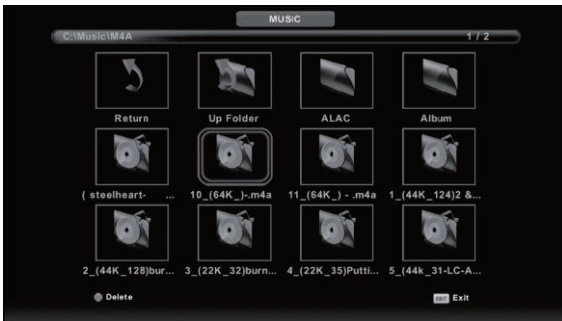
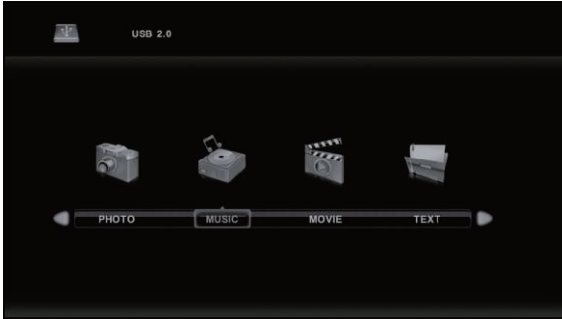

Press ◀/▶ button to select drive disk you want to watch, then press Enter button to enter. Press ◀/▶ button to select

return option to the previous menu.



Movie Menu

Press ◀ / ▶ button to select MOVIE in the main menu, then press Enter button to enter. Press Exit button to return to the previous menu and exit menu to quit.



Press ◀ / ▶ button to select drive disk you want to watch, then press Enter button to enter.

Press media button to play the selected movie.

Press display button to select menu in the bottom you want to run, then press Enter button to operate.

Press Exit button to back to the previous menu and exit button to quit the entire menu.

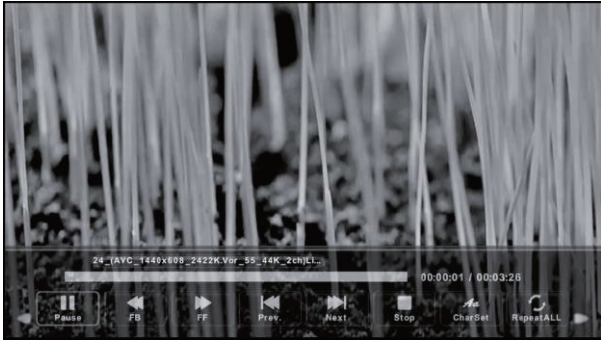

Text Menu

Press ◀ / ▶ button to select TEXT in the main menu, then press Enter button to enter. Press Exit button to return to the previous menu and exit menu to quit.

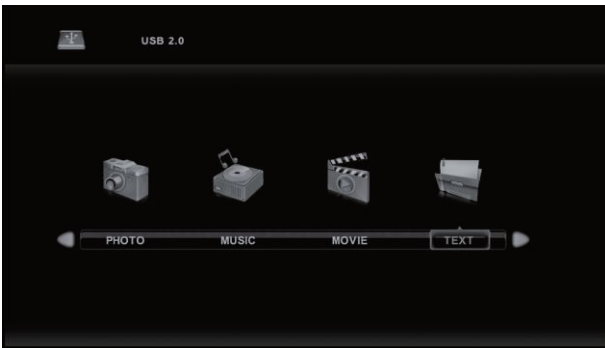

Press ◀ / ▶ button to select drive disk you want to watch, then press Enter button to enter. Press ◀ / ▶ button to select return option to back to the previous menu.

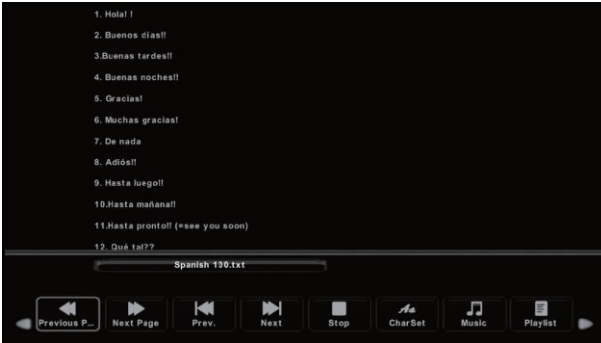

Multimedia Playback Format

Multimedia Categories	File Extension
Video	*.avi/MPEG(*.mpeg,*.dat,*.vob) / MPEG-4(*.mp4) / TS(*.ts,*.trp,*.tp) / MKV(*.mkv) / *.flv / VC-1 / WMV9(*.wmv,*.asf) / RMVB(*.rm,*.rmvb)
Music	*.mp3/AAC(*.aac,*.m4a)/*.wav
Photo	*.jpg/*.jpeg
Text	*.txt

SMART TV

Welcome Page

When the Android Box is first powered up, Welcome Page will be shown. It will help you to configure the device.



If you want to skip this wizard, press “HOME” key
If you have finished this wizard once, it will not auto-open again.

Setup page

1.1 Select Language:
Select network type:

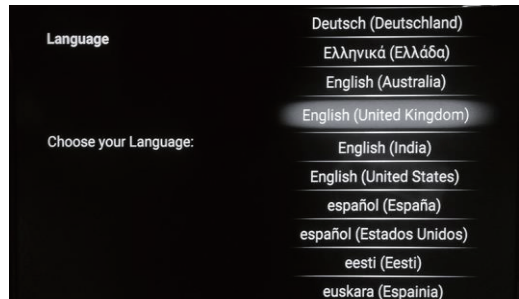
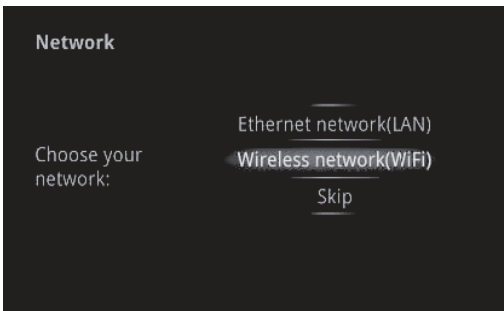

if you do not want to choose your network you can skip this step by press “Skip”
You will also find the network settings in function “Settings”

Select Wireless network(Wi-Fi)

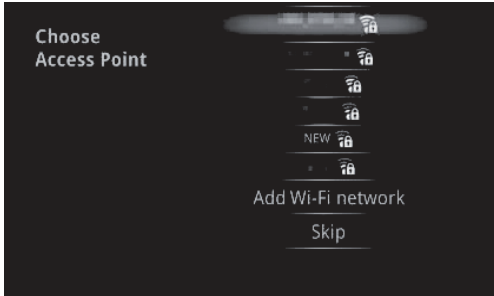

If choose ' Wi-Fi', select a Wi-Fi Access Point If choose 'Ethernet', the screen will show Ethernet connection status

Select Ethernet network (LAN) Configure Ethernet manually

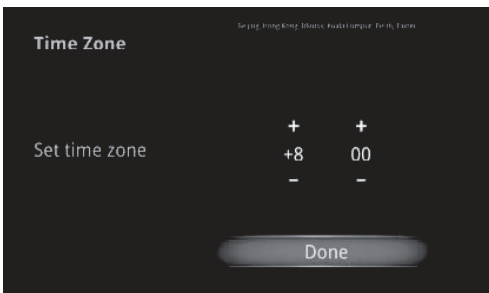
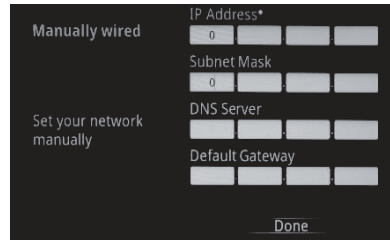
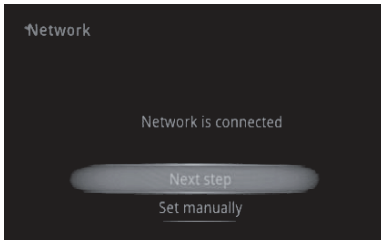

Set up the correct Time Zone If network is not connected, setup the date and time manually

Setup Date/time manually

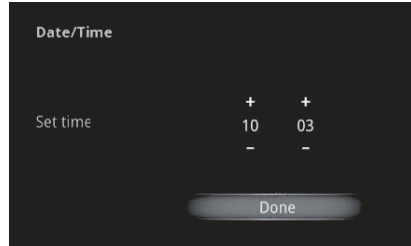
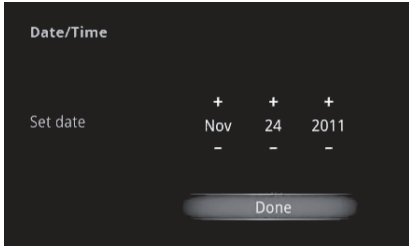

Configuration

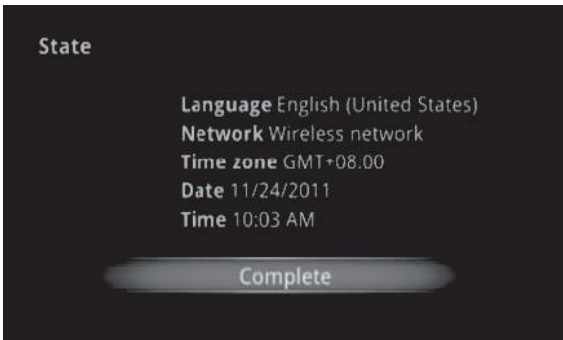

Adjust screen size, using the arrow buttons on remote control

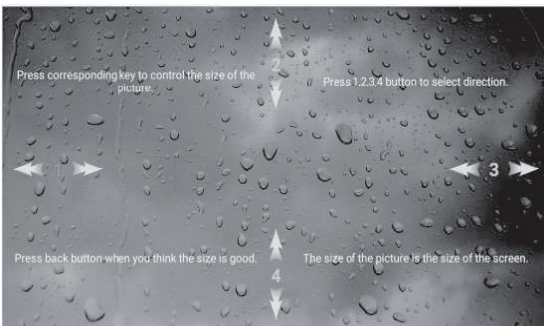

User can setup the Language, Network, Time Zone, Data/Time and adjust screen size in this part.

Main Launcher



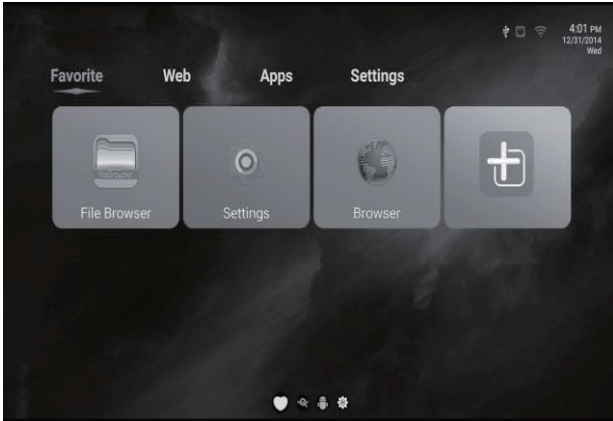



Press the arrow buttons ◀ / ▶ to select the sub-screen



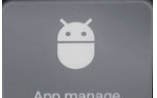

and press ▼ into sub-screen.

FUNCTION	DESCRIPTION
	Main Launcher tab contains : Time information(You can set time information at settings) ; USB/Ethernet/ Wifi function status(White for working, gray for standby)
	All App menu can view and select more apps.
	The Browser tab contains bookmarks and search bar. It allows you enjoy your time on surfing Internet. You can search for information and watch online TV etc.
	Add you favorite APP to this directory.
	The Settings screen contains most of the customizing and configuration options, such as language and network settings.
	Create necessary APP shortcuts to the main launcher.

Settings

FUNCTION	DESCRIPTION
<p>Wifi-settings</p> 	<p>Check to turn on Wi-Fi so can connect to Wi-Fi networks Check to receive an alert when an open Wi-Fi networks becomes available</p>
<p>Ethernet</p> 	<p>Turn on/off the Ethernet Ethernet settings: IP address , Subnet Mask, DNS Server, Default Gateway and etc</p>
<p>Advance settings</p> 	<p>Contains all of the settings</p>
<p>Factory reset</p> 	<p>Restore factory default</p>
<p>App manage</p> 	<p>Management application</p>
<p>Language & input</p> 	<p>Select language Android keyboard</p>
<p>System updates</p> 	<p>Local update Update system via update.zip from USB flash drive or micro SD card Net update OTA network upgrade</p>

<p>Date & Time</p> 	<p>Automatic date & time (Need network) Set date Set time Select time zone User 24-hour format Select date format : dd/mm/yyyy ; mm/dd/yyyy ; yyyy/mm/dd</p>
<p>About device</p> 	<p>Android version Build number</p>

Install from USB Flash Drive

1. Open the "File Browsers"
2. Choose your USB flash drive or any other mass storage's folder
3. Find you application, and press it
4. Press the install button
5. You can find the application in tab "Apps" after installation

2.1 Application

Download & install from Browser

1. Open the Browser.
2. Press search key and input your website address
3. Download the APK file which you like if there is a link for download
(If you have problems with downloading, please make sure there is, enough space in your internal storage)

Install from AppInstaller

1. Open the AppInstaller
2. Find the icon of the application, and enter it
3. Press the install button
4. You can find the application in tab after in stallation.

Note:

Software is provided "as is," and in no event we warrant that the software is error free or that customer will be able to operate the software without problems or interruptions. Apps downloaded from App Stores or side loaded may be incompatible with this device. Certain apps may be specifically written for mobile devices and optimised for certain CPUs or they depend upon additional sensors or hardware not present within this device. Please be advised that we cannot guarantee that any downloaded and installed software will be compatible with this device even if it previous versions run well as the various software developers may change their code and requirements regularly.

Playing certain games or apps may require additional USB or WIFI peripherals as keyboards, gyroscope remotes, game controllers etc. Warranty does not include software updates.

All trademarks mentioned belong to their owners, third party brands, product names, trade names, corporate names and company names mentioned may be trademarks of their respective owners or registered trademarks of other companies and are used for purposes of explanation and to the owner's benefit, without implying a violation of copyright law.

Operating system provided with this smart TV is a fork of Android Open Source Project.

TROUBLESHOOTING

Problem	Solution
No power	Insert the power plug securely into the power outlet.
No picture	Ensure that the equipment is connected properly.
Distorted or no sound	<ul style="list-style-type: none"> • Ensure the equipment is connected properly • Ensure that the input setting for the TV and stereo system are correct. • Adjust the master volume to a suitable volume by pressing V+/V- button. • Check audio settings are correct. • Check set isn't muted. • Unplug headphones • Check the antenna connection.
Remote control not working	<ul style="list-style-type: none"> • Check the batteries are installed with the correct polarities. • Replace the batteries with new, fully charged ones. • Point directly at the remote sensor on the TV and try again. • Operate at a distance of no more than 6m. • Remove any obstacles between the remote control and the sensor.
Buttons on the TV don't do anything	Disconnect the power plug and then reconnect it. (The unit may not be operating properly due to lightning, static, or other factors.)
Poor picture or no picture	<ul style="list-style-type: none"> • Adjust the indoor aerial, use an amplified aerial or external digital antenna. • Have the DTV antenna checked or installed by a professional installer • Move anything that may cause interference. • Retry Auto tuning the unit. • Try another channel.
Noise or other interference	Electronic equipment near the unit may be causing interference. Relocate the unit or move the equipment.
Smart TV not working	Perform factory reset

SPECIFICATIONS

eiq-CV49UHDT2SM

TV System	PAL DVB-T2
Maximum	3840x2160
Brightness	300 CD/m ²
Static Contrast	3000:1
Response Time	6.5ms
Consumption	<120W
Power Supply	AC100-240V – 50/60Hz
Connectivity	Composite Video Input Component Video Input HDMI input x 3 RF Antenna Input RJ45 input Optical
Data Interface	USBx4
Supported System Files	FAT32 and FAT16

eiq-CV55UHDT2SM

TV System	PAL DVB-T2
Maximum	3840x2160
Brightness	300 CD/m ²
Static Contrast	3000:1
Response Time	6.5ms
Consumption	<160W
Power Supply	AC100-240V – 50/60Hz

Connectivity	Composite Video Input Component Video Input HDMI input x 3 RF Antenna Input RJ45 input Optical
Data Interface	USBx4
Supported System Files	FAT32 and FAT16

eiq-CV65UHDT2SM

TV System	PAL DVB-T2
Maximum	3840x2160
Brightness	300 CD/m ²
Static Contrast	3000:1
Response Time	6.5ms
Consumption	<220 W
Power Supply	AC100-240V – 50/60Hz
Connectivity	Composite Video Input Component Video Input HDMI input x 3 RF Antenna Input RJ45 input Optical
Data Interface	USBx4
Supported System Files	FAT32 and FAT16

Multimedia Playback Format

Multimedia Categories	File Extension
Video	*.avi/MPEG(*.mpeg,*.dat,*.vob) / MPEG-4(*.mp4) / TS(*.ts,*.trp,*.tp) / MKV(*.mkv) / *.flv / VC-1 / WMV9(*.wmv,*.asf) / RMVB(*.rm,*.rmvb)
Music	*.mp3/AAC(*.aac,*.m4a)/*.wav
Photo	*.jpg/*.jpeg
Text	*.txt

Remote Control

Signal Type	Infrared
Control Distance	8 meters
Control Angle	30° (Horizontal)
Power Supply	AAA 1.5V x 2

PRODUCT DISPOSAL

Do not dispose this product as unsorted waste. Collection of such waste must be handled separately as special treatment is necessary.

Recycling facilities are now available for all customers at which you can deposit your old electrical products. Customers will be able to take any old electrical equipment to participating civic amenity sites run by their local councils. Please remember that this equipment will be further handled during the recycling process, so please be considerate when depositing your equipment. Please contact the local council for details of your local household waste recycling centres.



