



Wall Mounted Inverter Multi Split Air Conditioner with Heat Pump

User and Installation Manual

eiQ-3MS9K9K9K



Thank you for choosing ElectriQ

Please read this user manual before using this innovative

Air Conditioner and keep it safe for future reference.

Visit our page www.electriQ.co.uk for our entire range of Intelligent Electricals

CONTENTS

SAFETY INSTRUCTIONS	3
OPERATION	4
REMOTE CONTROL	5
FILTERS	8
END OF SEASON	8
START OF SEASON	8
REPLACING THE BATTERIES	8
INSTALLATION GUIDE	9
INSTALLATION OF THE OUTDOOR UNIT	15
PIPELINES CONNECTION & AIR PURGING	16
ELECTRICAL CONNECTION OF THE AIR CONDITIONER	19
TROUBLESHOOTING AND SELF DIAGNOSIS	20
TECHNICAL SPECIFICATIONS	22
APPENDIX	23

IMPORTANT NOTE:

This air conditioner is supplied in multiple boxes. Before an engineer visit is confirmed, ensure that all the boxes required have been received in good condition and the codes on each box matches your model on the table below:

Model	Outdoor		Indoor		Pipekit	
		QTY		QTY		QTY
eiQ-3MS9K9K9K	eiq-3MSC2XWINSOUT	1	eiq-9wminv3MSIN	3	Eiq-9wminvIN5m*	3

The retailer and manufacturer will not be liable for failed installation, or problems occurring due to the above not been checked prior to arranging installation.

*PIPEKIT12K-5M may also be supplied, which is the same specification. A range of pipe kits and pipes are available from the retailer. Longer pipes will require the addition of refrigerant by an F-gas registered engineer.

SAFETY INSTRUCTIONS

Important!

- Carefully read the instructions before operating the unit
- This appliance comprises of three indoor units and an outdoor unit. The slim wall mounted evaporators are designed exclusively for indoor installations while the external condenser should be installed outside, ensuring it is kept away from flood water or snow lines.
- Rating: This unit must be only connected to a 220-240 V / 50 Hz earthed power source.
- Installation must be in accordance with the regulations of the country where the unit is used.
- These air conditioners are supplied with refrigeration pipes and electrical cables. European Union regulations requires for an F-Gas trained engineer to handle any operation where non-qualified intervention could case fluorinated gas to escape. A commissioning certificate must be issued with any installation.
- If you are in any doubt about the suitability of your electrical supply have it checked and, if necessary, modified by a qualified electrician.
- This air conditioner has been tested and is safe to use. However, as with any electrical appliance - use it with care.
- Disconnect the power before dismantling, assembling or cleaning.
- Avoid touching any moving parts within the appliance.
- Never insert fingers, pencils or any other objects through the guard
- This appliance is not intended for use by persons (including children) with reduced physical, sensory or mental capabilities. It is also not intended for use by those with a lack of experience and knowledge, unless they have been given supervision or instruction concerning the use of the appliance by a person responsible for their safety. Do not leave children unsupervised with this appliance.
- Do not clean the unit by spraying it or immersing it in water.
- Never connect the unit to an electrical outlet using an extension cord. The outdoor must be hardwired by a qualified electrician.
- Never operate this appliance if the cord is damaged. Ensure the power cord is not stretched or exposed to sharp objects or edges.
- A damaged supply cord should be replaced by the manufacturer or a qualified electrician in order to avoid a hazard.
- Any service other than regular cleaning or filter replacement should be performed by an authorized service representative or a qualified air conditioning engineer. Failure to comply could result in a voided warranty.
- Do not use the appliance for any purpose other than its intended use.
- The outdoor part of the air conditioner unit must always be stored and transported upright, otherwise irreparable damage may be caused to the compressor; if in doubt we suggest waiting at least 24 hours before starting the unit.
- Avoid restarting the air conditioning unit unless 3 minutes have passed since being turned off. This prevents damage to the compressor.
- Never use the mains as a switch to start and stop the air conditioning unit. Use the provided ON/OFF button located on the remote control.
- Always place the unit on a dry and stable surface. Install the outdoor unit on a wall using wall mounting brackets or fix to a floor slab with special floor mounting fittings away from flood or snow lines.
- The indoor unit should not be installed in damp environments such as laundry or wet rooms

Energy Saving and Unit Safety Protection Tips

- Do not cover or restrict the airflow from the outlet or inlet grills.
- For maximum performance the minimum distance from a wall or other objects should be 50cm.
- Keep the filters clean. Under normal conditions, filters should only need cleaning once every four weeks (approximately). Since the filters remove airborne particles, the frequency of cleaning is dependant on the air quality.
- During the initial start up set the fan speed to maximum and the thermostat to 4-5 degrees lower than the current temperature. After, set the fan speed to low and set the thermostat to your desired setting.
- To protect the unit we recommend not using the cooling function when the ambient indoor temperature is higher than 35°C.
- To protect the unit we recommend not using the heating function when the indoor ambient temperature is lower than 7°C.
- Note the manufacturer operating temperature ranges at the end of this user manual.

OPERATION

Cooling

The compressor (6) in the exterior unit compresses the refrigerant into a high-temperature, high-pressure gas. When this gas flows along the cooling fins of the condenser (7), heat is exuded and the gas condenses into a liquid, which is led to the evaporator (1) within the indoor unit. The liquid expands into a gas at a low temperature and low pressure is converted. This gas absorbs the warmth from the air in the room, the cooled air is blown back into the room and the heat is moved to the compressor along with the gas.

A fan (3) draws the air over the filter and blows the cooled air back into the room. A fan (8) draws air over the condenser and blows warm air away.

1. Evaporator
2. Filter
3. Evaporator Fan
4. Gas Line
5. Liquid line
6. Compressor
7. Condenser
8. Condenser Fan

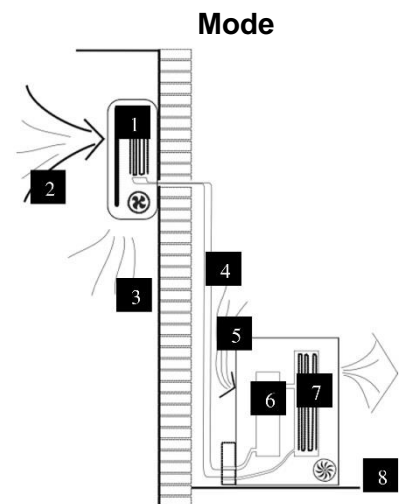

Heat Pump Mode

The system operates in reverse: the condenser works as an evaporator, the evaporator as a condenser: warm air is blown into the room. It is ideal as a maintenance heating when outside temperatures are not too low and when the indoor temperature is above 7°C.

Dehumidifying

As with cooling, the moisture in the air condenses on the cold evaporator at room temperature acting as a powerful dehumidifier.

NOTE:

This is a multisplit system and multiple indoor units are connected to a single outdoor compressor. Please make sure that the indoor units are set to operate in same mode. Multiple indoor units connected to the same compressor cannot operate in different modes at the same time although you are able to set different target room temperatures for each unit. Fan only mode can be operated while other units are in heating or cooling.dd

REMOTE CONTROL

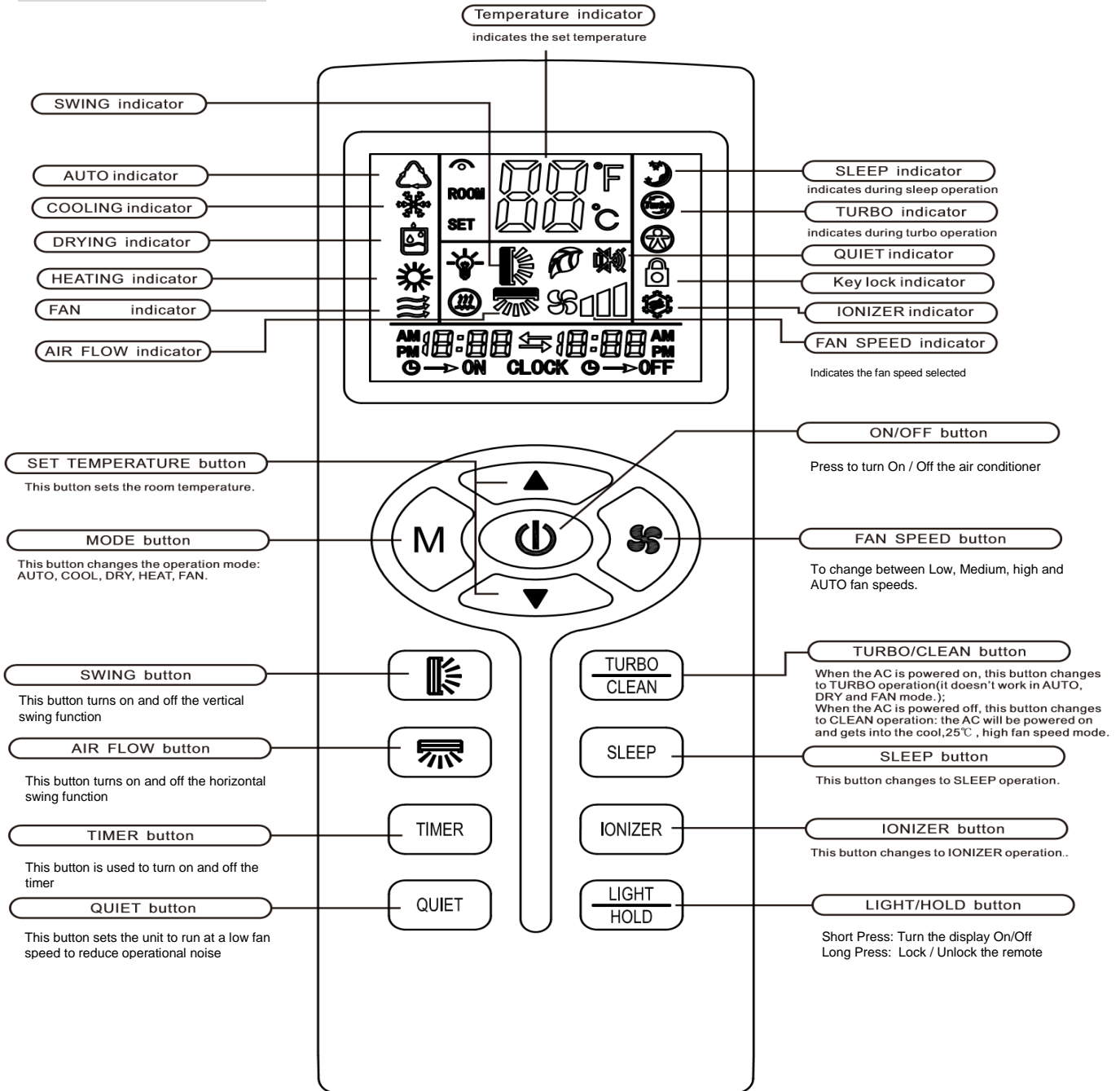

The remote control has a range of up to 8m. Point the remote control at the receiver in the indoor unit. A beep confirms that the remote control signal has been received.

NOTE: The LIGHT, IONISER and CLEAN functions may not be available on all models

REMOTE OPERATION

Turn the appliance on with the **ON/OFF** button. This starts the unit with the last used settings. The ON/OFF button will also turn off the air conditioner.

TEMPERATURE

The desired temperature is set using the up and down buttons, within the range of 16°C – 32°C.

FAN SPEED

Use this button to set the fan speed between low, medium, high and automatic (the corresponding symbol on the display will flash). The fan speed in the automatic setting is determined by the difference between the desired temperature set and the room temperature.

COOLING MODE

1. Repeatedly press the **MODE** button until the **COOL** indicator appears.
2. Set the desired temperature using the **TEMPERATURE** up and down buttons.
3. Use the **FAN SPEED** button to set the fan speed.

HEATING MODE

1. Repeatedly press the **MODE** button until the **HEAT** indicator appears
2. Set the desired temperature using the **TEMPERATURE** up and down buttons.
3. Use the **FAN SPEED** button to set the fan speed.

FAN MODE

1. Repeatedly press the **MODE** button until the **FAN** indicator appears.
2. The temperature settings will not affect the fan operation
3. Use the **FAN SPEED** button to set the fan speed.

DEHUMIDIFY MODE

1. Repeatedly press the **MODE** button until the **DEHUMIDIFY** indicator appears.
2. The **FAN** button does not work in dehumidify mode. The fan speed will always be low in this mode. Also temperature cannot be adjusted in dehumidifying mode

AUTO MODE

1. Repeatedly press the **MODE** button until the **AUTO** indicator appears. Set the desired temperature under auto mode to the required level between 16~32 °C
2. The difference between the set temperature and the room temperature determines how the air conditioner operates: cooling, heating or fan.
3. Once the temperature is set in auto mode it is not possible to amend it. If the desired temperature requires changing, change the unit out of Auto mode before changing it back.
4. The unit will operate in the auto selected mode until set temperature is reached then switches the compressor off. Mode is locked until reset via mode button.
5. You can use the FAN button to set the fan speed while in Auto mode.
6. All indoor units must be operating in the same mode, otherwise a mode mismatch error will show.

SLEEP MODE

During sleep mode the unit will operate with a low fan speed to minimise the operational noise of the unit.

1. Press the **SLEEP** button
2. Set the desired temperature.
3. Press the **SLEEP** button; **SLEEP** indicator will appear on the display. Cancel the sleep mode by pressing this button again.

CLEAN (Not available on all models)

When pressed while the unit is in standby mode, the unit will power on in high speed fan mode, and run through the cleaning mode, before returning to standby mode.

TURBO (Not available on all models)

When pressed the unit will operate at maximum fan speed and maximum cooling for 15 minutes.

1. Set the air conditioner to run with the settings required after Turbo has completed.
2. Press the TURBO button.

TIMER

OFF FUNCTION (While the air conditioner is on)

1. Ensure the air conditioner is turned on and running with your desired settings
2. Press the **TIMER** button to turn on the timer.
3. Use the up and down button to set the timer between 1 and 24 hours.
4. Once the time you have set has elapsed, the appliance will switch itself off.
5. To cancel the timer function before the set time has elapsed, press the **TIMER** button again.

ON FUNCTION (while air conditioner is in standby)

1. Ensure the air conditioner is in standby mode.
2. Press the **TIMER** button to turn on the timer.
3. Use the up and down button to choose from 1-24 hours timer setting.
4. Set the desired operation, temperature, fan speed, etc.
5. Once the time you have set has elapsed, the appliance will switch itself on.
6. To turn off the timer function before the set time has elapsed, press the **TIMER** on button again.

IONISER (Not available on all models)

When turned on the ioniser uses an electrical charge to remove particles from the air, improving air quality.

QUIET BUTTON (Not available on all models)

When activated the air conditioner will operate with settings such as low fan speed to minimise the operational noise.

IMPORTANT

AUTO RESTART: The air conditioner will automatically restart when electricity is restored after a power cut. If in doubt, check the settings.

RANGE OF THE INTERNAL THERMOSTAT: The internal thermostat can be set at a desired temperature between 16 and 32°C. Note that whether the desired value can be achieved depends on a number of factors including the units power, room size, temperature and insulation of the room.

RANGE OF HEAT PUMP FUNCTION: The heat function can be used when the external ambient temperature is 5°C or higher. The performance of the heat pump will degrade as the external temperature reduces.

CAPACITY: The required cooling or heating capacity depends greatly on the location and/or use of the room where the air conditioner is installed. Strong sunlight and the presence of people, lights or equipment create an additional heat load. Normal living spaces require about 100 W per square metre of floor surface. In strong sunlight or if other sources of heat are present, this may be as much as 350 W/sqm.

Tip: On warm days, let the air conditioner cool the room as much as possible during the night and set the temperature constant from night to daytime.

EMERGENCY START: In the event of a problem, the air conditioner can be operated using the emergency button under the panel in the indoor unit. Open the front panel and press the button, the air conditioner will:

-heat if the room temperature is 20 °C or less, cool if the room temperature is 25 °C or more and for values in between will dehumidify.

FILTERS

Turn off the appliance from the consumer unit before attempting to service the filters.

Opening the front panel: at the A recesses, pull the front part up with both hands. The front panel will stay horizontal (at around 90°).



Closing the front panel: press the front part down at the sides at B and in the middle at. Make sure it is properly closed (click).

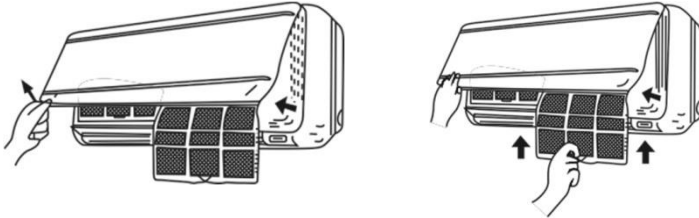
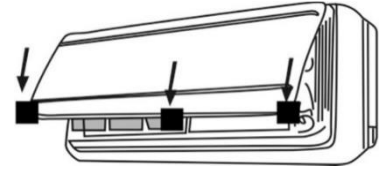

1. Hold the front panel open (or put it in horizontal position) and remove the filter(s).
2. Use a vacuum cleaner to remove dirt. If the dust filter is very dirty, it may be washed in lukewarm water with a very small amount of neutral detergent. Rinse well and allow to dry completely (not in direct sunlight or near a source of heat).
3. Keep the grid panel open and reinstall the filter(s). Press the panel shut; a click indicates it is closed properly.
4. Restore the power from the consumer unit and turn the air conditioner on.

Indoor Unit: While the unit is disconnected from power dust regularly with a dry cloth or slightly damp paper towel. Never use chemicals or solvents. Never spray a liquid in or over the appliance.

Exterior unit: While the unit is disconnected from power. Remove dirt and keep the air intake and exhaust openings free of debris, etc. Cleaning with chemicals may cause damage.

END OF SEASON

If the air conditioner is not going to be used for an extended period:

- Set in fan mode on a warm day so that the inside of the appliance fully dries out.
- Switch off the power from fuse box and remove the batteries from the remote control.
- Clean the filters

START OF SEASON

If the air conditioner is to be used again after an extended period:

- Check that the air intake and exhaust openings of the indoor and exterior units are not blocked. Remove any dirt and debris.
- Check that the filters are installed and are clean.
- Check that the condensation outlet drains properly and there is no dirt or organic blockage (otherwise leakage may occur)
- Install 2 AAA batteries in the remote control.
- Turn the appliance on, set the time and desired settings.

REPLACING THE BATTERIES

- Remove the battery cover.
- Replace the AAA batteries, following the markings for the polarity
- Replace the battery cover.
- Press the on/off button; if no symbols appear on the display, the batteries are empty or have been incorrectly installed.

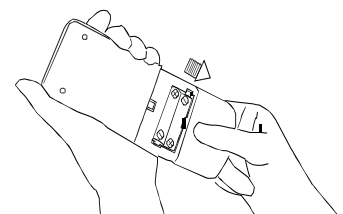

INSTALATION GUIDE

SAFETY

- Only qualified personnel should install this appliance.
- This installation manual is intended for use by individuals possessing adequate backgrounds and qualifications in electrical, electronic, refrigerant and mechanical fields.
- Any attempt to install or repair the appliance may result in personal injury and/or property damage.
- The manufacturer and retailer cannot be held responsible for the interpretation of this information, nor can it assume any liability in connection with its use.
- The units are designed for permanent installation.
- The equipment is designed for domestic or office use and we are not making any endorsements for its use in industrial or maritime environments.
- Do not place near sources of heat, vapours, industrial machine oil or other flammable gases.
- High frequency waves generated by radio equipment, welders and medical equipment will interfere with the normal operation of the unit.
- Install this device only when it complies with local/national legislation, ordinances and standards. Check the mains voltage and frequency. This unit is only suitable for an earthed electrical supply, connection voltage 230 V~ / 50 Hz.
- The information, specifications and parameter are subject to change due to technical modifications or improvement without any prior notice. The accurate specifications are presented on the nameplate label.
- Please read this installation manual completely before installing the product.
- When the power cord is damaged, replacement work shall be performed by authorized personnel only.
- Installation work must be performed in accordance with all European, national and / or local directives and standards and must be done by authorized personnel only.
- Always make sure to wear the correct personal safety protections such as protective eyewear, gloves, ear protection etc.
- This air conditioner contains a refrigerant and can be classified as pressurized equipment. Therefore always contact a qualified air conditioning engineer for installation and maintenance of the air conditioner. The air conditioner must be inspected and serviced on an annual basis by a qualified air conditioning engineer.
- For your convenience you can download the latest version of the user / installation manual from www.electriq.co.uk

INDOOR UNIT POSITION

- The air inlet and outlet vents should be away from any obstruction, ensuring that there is a good airflow through the whole air-conditioned space.
- Select a position where the condensing water can be easily drained out, and the indoor unit can be easily connected to outdoor unit.
- The wall where the unit is fixed should be strong enough to withstand the full weight and vibration of the unit.
- The unit should be accessible for service and maintenance.
- The height of the installed unit should be ideally more than 200cm from floor.
- The air conditioner must not be installed in a wet environment such as a bathroom, shower or swimming pool etc.

OUTDOOR UNIT POSITION

- A convenient position, dry and well ventilated, outside of direct sunlight or strong winds, which is not on flood line and where noise and airflow does not cause interference or inconvenience.
- Select a location where there should be no obstructions to the inlet and outlet vents.
- The location should be able to withstand the full weight and vibration of the outdoor unit and permit safe installation.
- Make sure that the outdoor unit installation is made in respect to installation dimension diagram with easy maintenance access.
- Select a place where it is out of reach of children.
- Do not block utilities access or fire escapes.
- The external unit must be lifted and put in place by two people or by specialised equipment.

NOTES:

- Only use the correct power supply voltage making sure the correct sized power cables are used
- The appliance shall be installed in accordance with standard wiring regulations by qualified personnel.
- Only replace fuses according to their printed rating or corresponding pcb boards.

RECOMMENDED INSTALLATION SPACING DIAGRAM

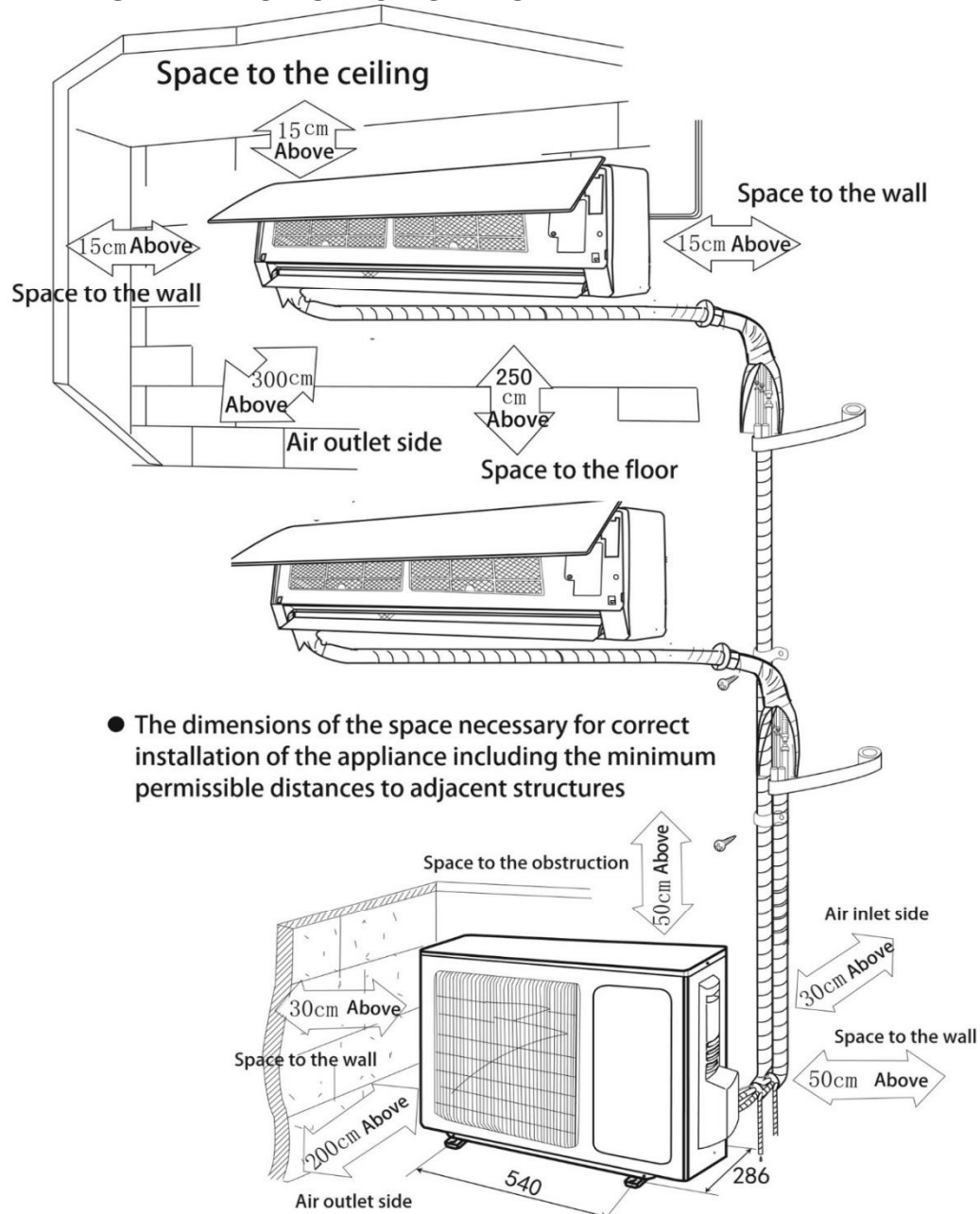

TOOLS RECOMMENDED FOR INSTALLATION



Electric drill



Hammer



Screwdrivers



Tape measure



Core hole cutter



Spirit level



Number 14 (7mm)
Masonry drill bit

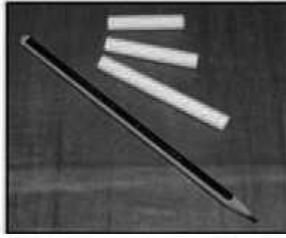

Pencil and chalk



1.5 inch number
10 screws
(Roundhead slotted)



Small Step ladder



7mm Wall plugs



Protective glasses
and mask



Pipe & cable detector

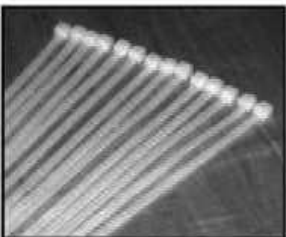

4 inch plastic ties

Also the following



2 inch Pipe clips



Circuit breaker when drilling inside and out



Garden gloves when lifting the outdoor unit



Dustsheets



Foam Filler



Silicone sealant and gun



1. Check the area for any hidden wires or pipes.



2. Mark the right hand backplate screw position.



3. Remove the backplate and drill a 7mm hole.

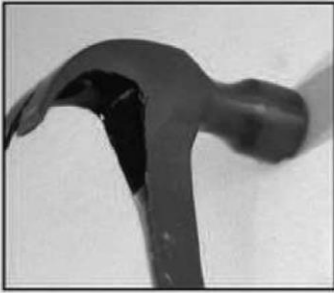

4. Tap home a 7mm wallplug.

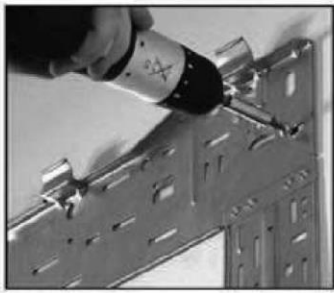

5. Screw the backplate to the wall using 1.5 inch number 10 screws.



6. Check level, mark the other holes and swing the backplate away.



7. Drill the rest of the holes and tap in wallplugs

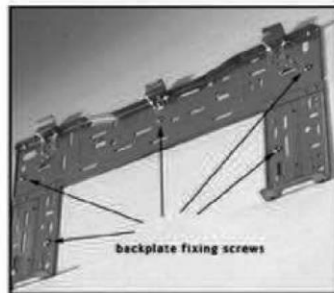

8. Fix the backplate to the wall.

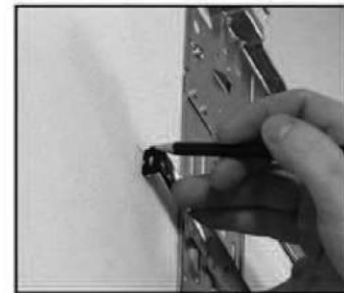

9. Mark the hole centre make sure the 3.5 inch cutter will clear the backplate.



10 Drill the hole at a slight downward angle. When you feel the pilot drill exit the outside wall stop



11. Finish the hole from the outside to keep it clean



12 Feed the cord and drain hose carefully through the wall

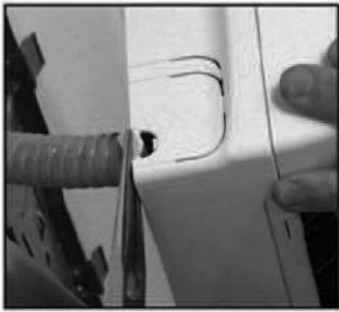

13. Undo the power lead and break out the plastic lead tab.

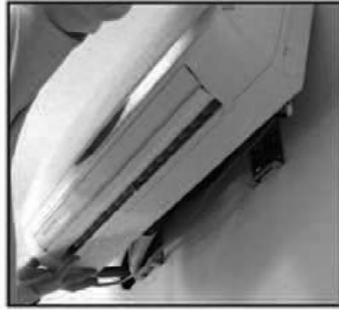

14. Hook the indoor unit onto the top of the backplate.



15. Lock the bottom of the unit onto the base of the backplate.

Notes:

Install the rear panel

1. Always install the rear bracket horizontally. The pipes in the unit can be installed to the left (default) or can be changed to exit on the right side. If the drain pipe needs to be changed from left to right then the rubber bung on the right side needs to be moved to the left outlet to avoid leakage. The outlet of the water tray needs adjusting down so the water follows the gravity fall. If the drains is running against gravity at any stage, goes above the tray level or the run is longer than 5 meters, an inline water pump must be used.
2. Fix the rear bracket to the wall using screws and suitable wall plugs.
3. Be sure to use the correct screws and fixings for the type of wall where the bracket is installed, and that the mounted bracket can withstand at least 60 kgs of weight. The weight should be equally distributed between each screw.

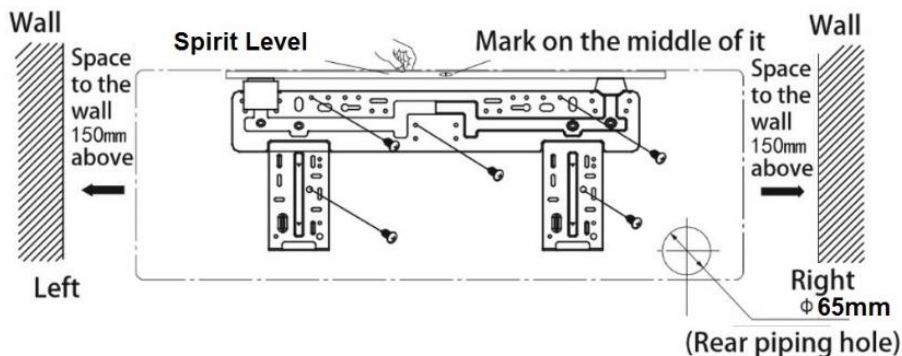

Install the piping hole

1. Drill a piping hole (90mm) through the external wall at a slight downwards angle
2. Insert the piping sleeve in to the hole to prevent damage to the connecting copper pipes and wiring when they are passed through the opening.

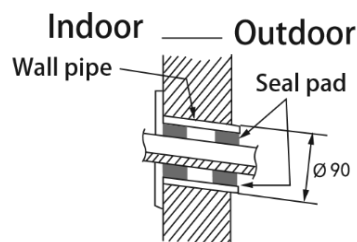

The pipework can be fed out of either the right or the left of the indoor unit as seen in fig. 1. Please cut off the pipe hole guards if you are changing the pipe position. The unit also features alternative guards for more pipe positioning.

Make sure that the drain pipe is routed under the pipework. (Fig.3) (When the drain pipe passes through the room interior, some condensed water might occur to its surfaces if the humidity is very high).

Tidy up the copper pipes, electrical cables and water drains and pass them through the piping wall hole drilled earlier (fig.2).

Hang the mounting slots of the indoor unit on the wall mounting bracket making sure it is tight in place (fig.3), so that the hooks at the bottom of the indoor unit match the hooks of the wall mounting bracket (fig.4)

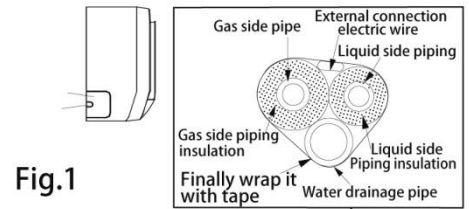

Fig.1

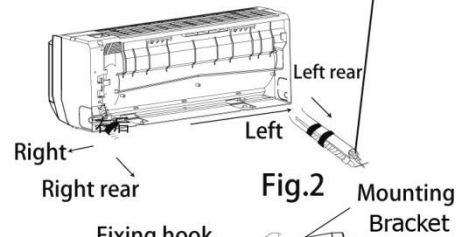

Fig.2

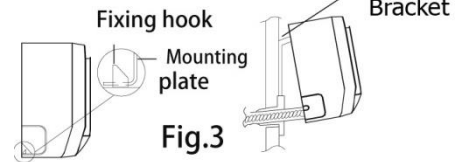
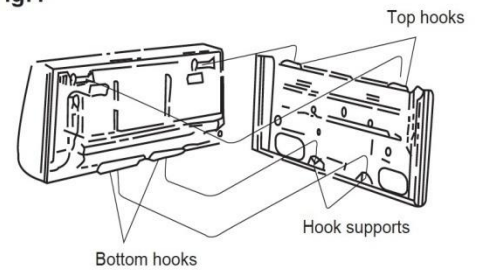

Fig.3

Notes:

1. The height of the installed unit is recommended to be > 200 cm.
2. Either the indoor unit or the outdoor unit can be higher, but the height difference must comply with a max. 5 metres level difference.
3. Try to avoid the bending of the pipes as much as possible so as to prevent possible negative impacts upon the performance of the unit.

Fig.4



INSTALLATION OF THE OUTDOOR UNIT

Try to move the product to the installation location in its original packaging to prevent damage. As the gravity centre of the unit is not at the installation centre, special caution should be taken when using hoisting cables to lift the unit. During transport, the outdoor unit must not be tilted in excess of 45 degrees (also do not store the unit horizontally). Use expansion bolts to fix the mounting supports to the wall; Use bolts and nuts to fix the outdoor unit firmly on the support, ensuring the installation is level; if the unit is installed on a wall or a rooftop, the supports have to be firmly fixed so as to resist earthquake or strong wind.

Dimensions for parallel indoor units installations

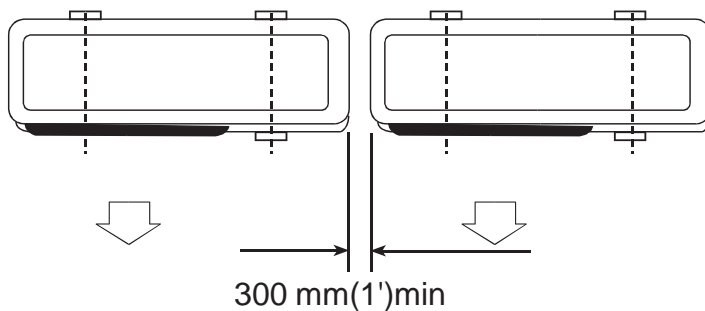

PIPELINES CONNECTION & AIR PURGING

No dust or any other particles, air or moisture should be allowed to enter the air conditioning system. Careful attention should be paid when the pipeline connection of the units are made. Try to avoid repeated curves as much as possible; otherwise damage to the copper pipes may occur. Suitable wrenches should be used when the pipeline connection is done so as to ensure the appropriate torque is applied (refer to following torque table). Excessive torque action might damage the joints while too little torque might lead to leakage.

Torque based upon the wrench to be used

Copper pipe diam.	Tightening torque	Strengthened tightening torque
6.35(1/4")	160kgf.cm(63kgf.inch)	200kgf.cm(79kgf.inch)
9.52(3/8")	300kgf.cm(118kgf.inch)	350kgf.cm(138kgf.inch)
12.7(1/2")	500kgf.cm(197kgf.inch)	550kgf.cm(216kgf.inch)
15.88(5/8")	750kgf.cm(295kgf.inch)	800kgf.cm(315kgf.inch)
19.05(3/4")	200kgf.cm(472kgf.inch)	1400kgf.cm(551kgf.inch)

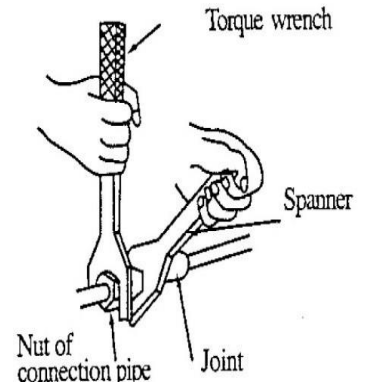

If you are installing a multisplit system with easy fit connectors follow the procedures below:

1. Remove the dust caps from the indoor and outdoor units and the connecting pipe.
2. Align the joint of the connecting pipe between the indoor and outdoor and tighten the connecting nut by hand to prevent cross threading. Secure them with a wrench, applying the maximum torque as shown in the table above.
3. Pressure test and vacuum pump the pipework.
4. Remove the two valve core caps from the outdoor unit and turn on the high and low pressure valve cores with a socket wrench, then tighten the two valve core caps of the outdoor unit. Finally you can wrap hot insulating tape around the joints of indoor and outdoor units

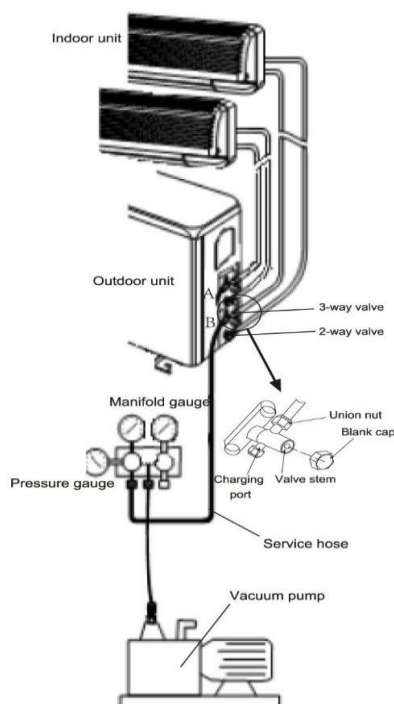
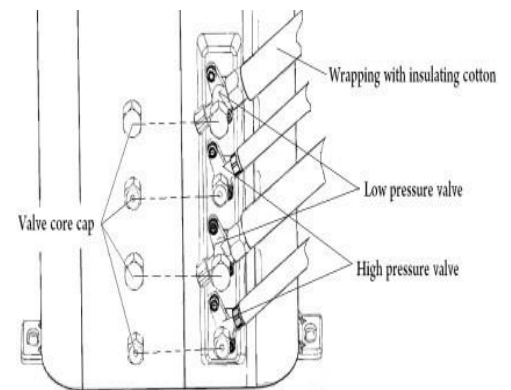

AIR PURGING WITH VACUUM PUMP

1. Check that pipelines connection have been properly connected, remove the charging port cap, and connect the manifold gauge and the vacuum pump to the charging valve using service hoses as shown
2. Open the valve on the low-pressure side of the manifold gauge, then run the vacuum pump. Vacuum the indoor unit and the connecting pipes until the pressure in them lowers to below 1.5mmHG (The operation time for vacuuming is about 10 minutes). When the desired vacuum is reached, close the low pressure valve on the manifold and stop the vacuum pump.
3. Disconnect the service hoses and fit the cap to the charging valve.
4. Remove the blank caps, and fully opens the spindles of the 2-way and 3-ways valves with a service valve wrench.
5. Tighten the blank caps of the 2-way and 3-ways valves, applying the torque listed in the table above.

ADDING REFRIGERANT

Refrigerant must be added if the pipework measures more than 5 metres (16'5") in length. This operation can only be performed by a professional F-Gas engineer, for the additional refrigerant quantity, please refer to the table.

ADDITIONAL REFRIGERANT AMOUNT
Liquid pipe diameter 6.35 (1/4")
(pipework length - 5)m x 30g









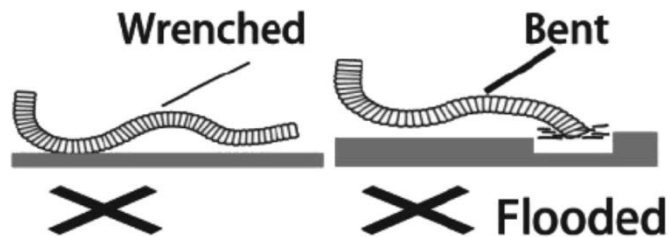

GAS LEAKAGE INSPECTION

After the pipeline connection is done, use a leakage inspection device to carefully check if there is any leakage at the joints. This is an important step to ensure the quality of installation. Once a leak is detected, proper action should be taken immediately.

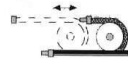
Install the water drainage pipe

1. For good drainage, the drain hose should be angled downwards.
2. Do not pull on or bend the drain hose or flood its end with water.
3. When the long drainage hose passes through indoor areas, it should be wrapped in insulation to prevent condensation building.



<p>To avoid damaging the pipework during unrolling. Ensure the packed soft pipes are vertical before extending</p>			<p>Please do not extend only one side of the pipework, as this could kink or damage the pipework</p>
<p>Please make use of a semicircle pulley to keep the allowed bending angle</p>			<p>Ensure the bends are not too severe, as this could restrict refrigerant flow, reducing performance or preventing operation.</p>
<p>Please use a twisting wheel to avoid improper bending.</p>			<p>Over bent soft pipes will lead to irregular bending</p>
<p>Please use a rigid elbow to maintain the bending angle while soft pipes operating.</p>			
<p>Avoid bending the pipe where possible, where bends are necessary their radius should be kept as large as possible.</p>			<p>Do not use short sharp angle bends.</p>

Notes: Please ensure you use the protective plastic tube and sleeves before passing the copper pipes through the wall in order to avoid pipe damage.

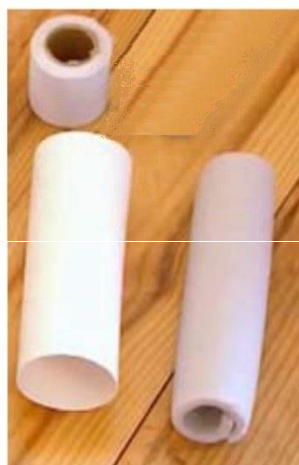

ELECTRICAL CONNECTION OF THE AIR CONDITIONER

- The electrical connections can be found under the protective plastic cover. Remove this from the side of the outdoor unit to gain access to the electrical connections.
- Connect the indoor power and control wires with the matching outdoor wire as per the electrical diagram.
- Do not attempt to connect the wires in a different way to the diagram on the air conditioner as this could damage the unit and invalidate the warranty.
- Secure the wires and replace the cover before operating the unit.
- The appliance should be installed in accordance with national wiring regulations.
- If the supply cord is damaged, it must be replaced by the manufacturer, its service agent or a suitably qualified person in order to avoid a hazard.
- The unit is designed to be hard wired and a suitable switch with a contact separation of at least 3mm in all poles must be added to the fixed wiring.
- Note: in some models you may connect the indoor wire connector with an optional outdoor defrost probe. The air conditioner electrical wiring must follow the specific country regulations. If power cord is damaged must be replaced by a qualified electrician.
- There are only three thread buckles on the electric box connection plate,
 - The left one is for the power line.
 - The middle one is for the cables for both Unit-A and Unit-B.
 - The right one is be used for Unit-C'.

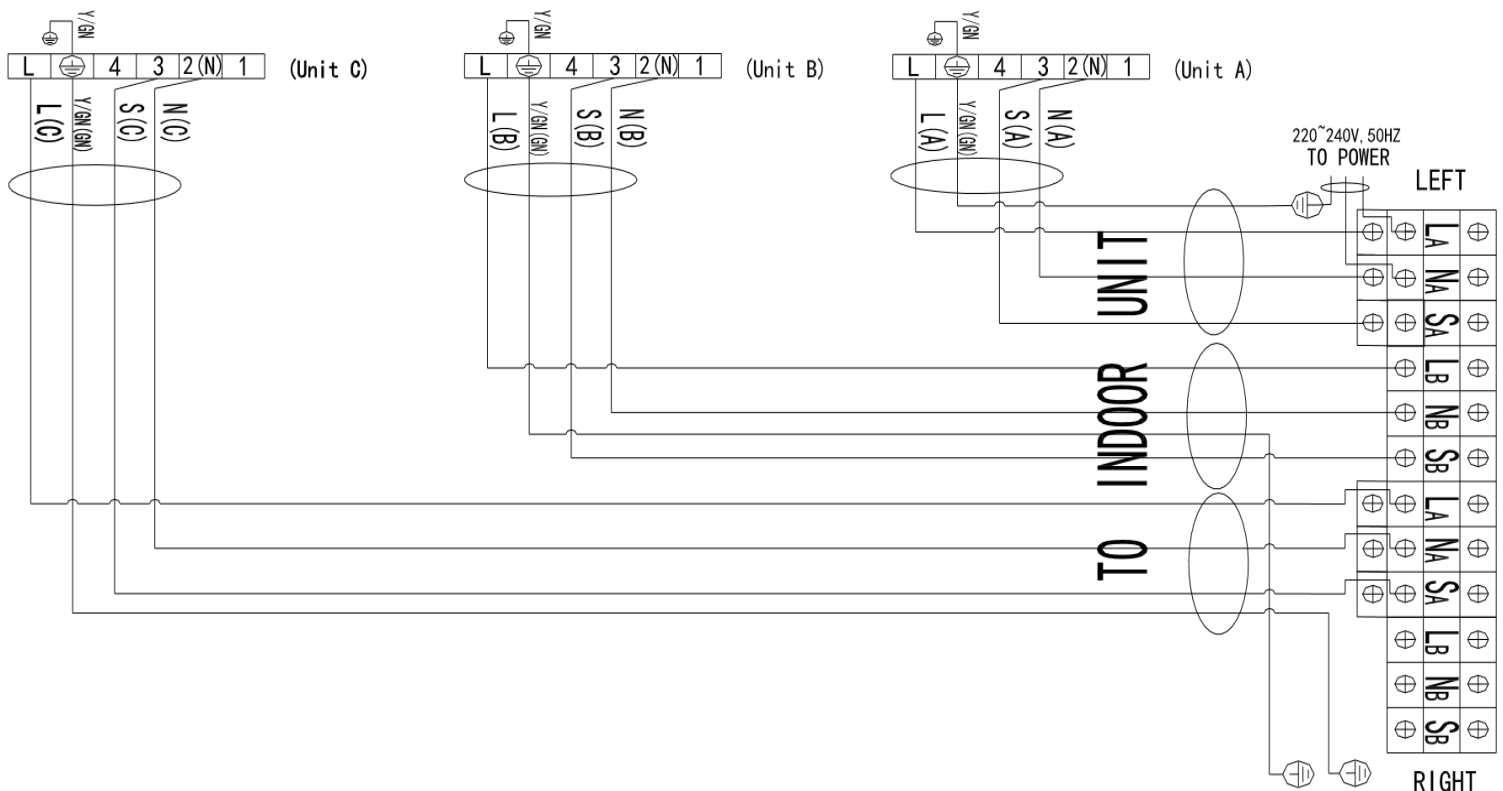

TROUBLESHOOTING AND SELF DIAGNOSIS

ElectriQ air conditioners have an advanced self-diagnosis system allowing them to display the service information

Protection and Fault Codes for Indoor Unit Board

Fault/Protection	Fault cause	Indoor Display
Zero passage fault of PG motor	Abnormal zero passage of PG motor	F0
Indoor and outdoor communication fault	Abnormal communication between indoor unit and outdoor unit	F1
Tr sensor fault	Open circuit or short circuit of Tr sensor	F2
Tp sensor fault	Open circuit or short circuit of Tp sensor	F3
Indoor fan fault	Malfunction of indoor fan	F4
PM 2.5 sensor fault(the function is not available for multi-split air conditioning system)	Open circuit or short circuit of PM 2.5 sensor(the function is not available for multi-split air conditioning system)	E9
Outdoor module fault	Malfunction of outdoor module	F5
Outdoor ambient temperature sensor fault	Open circuit or short circuit of outdoor temp sensor	F6
Outdoor coil temperature sensor fault	Open circuit or short circuit of outdoor coil temp sensor	F7
Compressor suction temperature sensor fault	Open circuit or short circuit of compressor suction temp sensor	F8
Compressor exhaust temperature sensor fault	Open circuit or short circuit of compressor extraction temp sensor	F9
Current and Potential transformer fault	Malfunction of current and potential transformer	FA
Compressor drive fault	Malfunction of compressor drive	FC
Power phase sequence fault or open phase fault	Power phase sequence fault or open phase fault	FD
Air return sensor fault	Open circuit or short circuit of air return sensor	FE
Outdoor DC fan fault	Malfunction of outdoor DC fan	FH
Multi-split mode conflict protection	Multi-split mode conflict protection	Fb

OUTDOOR BOARD FAULT CODES

Displayed Content	Fault Definition	Fault Cause
EEA	EEPROM fault	Fault of EEPROM on coordination board
EEB	EEPROM fault	Fault of EEPROM on outdoor board
E0	Fault of communication between coordination board and driver board	No communication or communication fault between coordination board and driver board
EC	Fault of communication between variable frequency module and outdoor unit	Communication fault between the outdoor unit power board and module
E0A	1# indoor communication fault	No communication or communication fault between 1# indoor and outdoor
E0B	2# indoor communication fault	No communication or communication fault between 2# indoor and outdoor
E0C	3# indoor communication fault	No communication or communication fault between 3# indoor and outdoor
E0D	4# indoor communication fault	No communication or communication fault between 4# indoor and outdoor
E0E	5# indoor communication fault	No communication or communication fault between 5# indoor and outdoor
E10	Weak current communication fault	Communication fault of coordination board and outdoor unit board
E9	Variable frequency drive/module fault	Driving occurs 3 times within 30 minutes or module protection
EP	Compressor shell roof switch fault	Too high temperature or the shell top of compressor or temperature switch is broken
EU	Voltage sensor fault	The system is unable to sense voltage
E3	T3 temperature sensor fault	Short circuit or open circuit of outdoor coil temperature sensor
E7	T4 temperature sensor fault	Short circuit or open circuit of outdoor ambient temperature sensor
E8	Exhaust temperature sensor fault	Short circuit or open circuit of exhaust temperature sensor
EH	Air return temperature sensor fault	Short circuit or open circuit of air return temperature sensor
EtA	1#T2B1 temperature sensor fault	Short circuit or open circuit of outlet temperature sensor of 1# outdoor coil
EtB	2#T2B2 temperature sensor fault	Short circuit or open circuit of outlet temperature sensor of 2# outdoor coil
EtC	3#T2B3 temperature sensor fault	Short circuit or open circuit of outlet temperature sensor of 3# outdoor coil
EtD	4#T2B4 temperature sensor fault	Short circuit or open circuit of outlet temperature sensor of 4# outdoor coil
EtE	5#T2B5 temperature sensor fault	Short circuit or open circuit of outlet temperature sensor of 5# outdoor coil
P0	IPM module protection	Compressor drive module is in abnormal status
P9	Compressor drive fault protection	Compressor drive is in abnormal status or unable to star
P9	HP dial setting fault	The type of driver board does not match that of compressor
P1	Low-voltage protection	Input voltage is lower than 160V±5V
P2	Compressor current protection	Running current exceeds the set value
P4	Exhaust gas high temperature protection	Exhaust temperature exceeds the shutdown protection value
H1	High-voltage switch protection	High-voltage switch is in abnormal status
H2	Low-voltage switch protection	Low-voltage switch is in abnormal status
P6	Refrigerator T3 overheat protection	Outdoor pipe temperature of refrigerator exceeds the set value

TECHNICAL SPECIFICATION

Model		9K+9K+9K	
(Ph-V-Hz) Rated volt and frequency		220-240V~50Hz,1Ph	
Recommended Circuit Breaker Size		27A	
Mode		Cooling	Heating
Rated capacity (W)	Single	1240W~3840W	1400W~4000W
	Triple	3000W~8500W	2500W~9000W
Cooling power input (W)	Single	320W~1470W	300W~1420W
	Triple	620W~3950W	580W~3900W
Heating current input (A)	Single	1.4~6.4A	1.3~6.2A
	Triple	2.8~18A	2.7~17.7A
SEER/SCOP(W/W)		6.5/A++	4/A+
Design load (W)		7000	6300
T biv. (°C) Heating balance point temperature		/	-7
T ol. (°C) Heating limit operating temperature		/	-10
thermostat-off mode (W)		cooling: 92W heating: 13W	
Stand by mode (W)		0.5	
Throttle type		EEV	
Annual Consumption (KW)		377	2205
Compressor	Model	ATL232SDNC9AUJ	
	Type (Rotary/Piston /scroll)	Rotary	
	Brand	Highly	
	Capacity (W)	6535	
	Power input (A)	2075	
	RLA (A)	10.7	
	Refrigerant oil	α68HES-H or equivalent 880±20ml	
Outdoor	Dimension (L*W*H) (mm)	970x370x790	
	Packing (L*W*H) (mm)	1120x485x890	
	Net/Gross weight (kg)	66/69	
	noise sound pressure level (dB/A)	60	
	Sound power noise (dB/A)	70	
	Refrigerant type/weight	R410A/2800g	
	Defrost mode	Automatic defrosting	
INDOOR UNIT:			
Model		Indoor unit	
Rated volt and frequency (Ph-V-Hz)		220-240V~/50Hz	
Cooling capacity (W)		2600W(1240~3840W)	2700W(1400~4000W)
Cooling power input (W)		810W(320~1470W)	790W(300~1420W)
Cooling current input (A)		3.5A(1.5~6.7A)	3.4A(1.4~6.6A)
Indoor	Indoor Air Circulation (m3/h)	≥550m3/h	
	Dimension (L*W*H) (mm)	780x276x202	
	Packing (L*W*H) (mm)	930x367x295	
	Net/Gross weight (kg)	10/12	
	noise sound pressure level (dB/A)	30~38	
	Sound power noise (dB/A)	40~48	
Refrigerant piping	Liquid side/ Gas side/Length (mm)	(φ6.35+φ9.52)×5000	
	Max. refrigerant pipe length /Max. difference in level	20m/10m	

Due to continuous product development process specification may change.

These units contain a gas governed by F-Gas regulations. The gas must be handled by qualified F-Gas engineers.

APPENDIX



Disposal: Do not dispose this product as unsorted municipal waste. Collection of such waste must be handled separately as special treatment is necessary.

Recycling facilities are now available for all customers at which you can deposit your old electrical products. Customers will be able to take any old electrical equipment to participating sites run by their local councils. Please remember that this equipment will be further handled during the recycling process, so please be considerate when depositing your equipment. Please contact the local council for details of your local household waste recycling centres.

WARRANTY INFORMATION

The **ElectriQ** guarantee provides cover against material or manufacturing faults. This means that if your air conditioner develops a fault during the guarantee period, we will arrange for it to be repaired or replaced.

Faults arising from a faulty installation are specifically excluded.

The system must be serviced annually by qualified personnel.

This unit must be operated under conditions as recommended in this user manual, at voltages indicated on the unit. Any attempts made to service or modify the unit by unqualified person, will render this WARRANTY VOID. This warranty is in addition to, and does not affect, your statutory rights.

Our warranty is RTB warranty and cover parts and labour only.

We recommend that you note the details of your purchase below and retain your original proof of purchase receipt with this manual. Keep these documents safe in the event of a warranty claim.

Purchase Date: _____

Retailer name: _____

Model number: _____

Serial number: _____

Installation Date: _____

Installer name: _____

Service Date: _____

Engineer/ Company name: _____

ElectrIQ UK SUPPORT

www.ElectrIQ.co.uk/support

Please, for your own convenience, check the troubleshooting guide before calling the service line.

If the unit still fails to operate call: 0871 620 1057 or complete the online form

Office hours: 9AM - 5PM Monday to Friday

www.ElectrIQ.co.uk

Unit J6, Lowfields Business Park
Lowfields Way, Elland
West Yorkshire, HX5 9DA