

electric*Q*

USER MANUAL



27 INCH LED MONITOR

eiQ-274K144IFSGHUCA

Thank you for choosing electricQ

Please read the user manual before using this monitor and keep it safe for future reference

Visit www.electriQ.co.uk to view our entire range of Intelligent Electricals

SETTLING IN OK?

We hope this has been helpful to you.

We would love to see how you're getting on with your new purchase, so please share any snaps you have on the platform of your choice below.

Our community awaits your uploads - Snap, tag and hashtag away!



@electriQUK
#electriQUK

WE'RE HERE TO HELP

Should you have any problems or questions with your purchase, please contact a member of our customer service team.

☎ 0330 390 3061

✉ support@electriQ.co.uk

Mon-Fri | 9am to 5pm

Unit J6, Lowfields Business Park,
Lowfields Way, Elland
West Yorkshire, HX5 9DA

CONTENTS



SAFETY	4
WHATS INCLUDED	6
STAND INSTALLATION	6
CONNECTIONS	8
GETTING STARTED	8
MONITOR CONTROLS	8
INDICATOR LIGHT	9
MENU OPTIONS	9
OSD MENU	10
INPUT	10
BRIGHTNESS/CONTRAST	10
COLOUR	11
PICTURE QUALITY	11
DISPLAY	12
AUDIO	12
MULTI-WINDOW	13
OSD	13
OTHER	14
TECHNICAL SPECIFICATION	15
TROUBLESHOOTING	16
SUPPORT	16

SAFETY INFORMATION

- Read these instructions - All the safety and operating instructions should be read before this product is operated.
- Keep these instructions - The safety and operating instructions should be retained for future reference.
- Heed all warnings - All warnings on the appliance and in the operating instructions should be adhered to.
- Follow all instructions - All operating and usage instructions should be followed.
- Do not use this equipment near water, or in humid environments - The appliance should not be used near water or moisture e.g. in a wet basement or near a swimming pool.
- Clean only with a dry cloth. Do not use solvents or petroleum-based fluids.
- Do not block any ventilation openings.
- Do not install near any heat sources such as radiators, stoves or other apparatus (including amplifiers) that produce heat.
- Do not tamper with the supplied plug. This plug is a BS1363 standard plug.
- Protect the power cord from being walked on or trapped, particularly at the plug and at the point where it exits from the appliance.
- Only use attachments/accessories specified by the manufacturer.
- Use only with a cart, stand, tripod, bracket or table specified by the manufacturer or sold with the apparatus. When a cart or stand is used, use caution when moving it to avoid any injuries or damage from it tipping over.
- Unplug the apparatus during lightning storms or when unused for long periods of time.
- Refer all servicing to qualified personnel. Servicing is required when the apparatus has been damaged in any way, such as if the power supply cord or plug is damaged, liquid has been spilled or objects have fallen into the apparatus or it has been exposed to rain or moisture, it does not operate normally or has been dropped.
- Please keep the unit in a well-ventilated environment.
- The monitor should only be connected to a mains power supply as rated on the back of the equipment.
- To prevent overload, do not share the same power supply socket with too many other electronic components.
- Do not place any connecting wires where they may be stepped on or tripped over.
- Do not place heavy items on the cable as this may cause damage.
- When removing from a socket hold by the plug and not the wires.
- Disconnect the power immediately and seek professional help if the plug or cable is damaged, liquid has spilt onto the unit, if accidentally exposed to water or moisture, if anything accidentally penetrates the ventilation slots or if the unit does not work normally.
- Do not remove the safety covers. There are no user serviceable parts

inside. Trying to service the unit yourself is dangerous and may invalidate the product's warranty. Only qualified personnel should service this apparatus.

- Do not block ventilation slots on the back cover. The monitor can be placed in a cabinet but ensure at least 5cm (2") clearance all around. Do not tap or shake the screen, this may damage internal components.
- **WARNING:** To reduce the risk of fire or electric shock, do not expose this apparatus to rain or moisture. The apparatus shall not be exposed to dripping or splashing and objects filled with liquids, such as vases, shall not be placed on the apparatus.
- **WARNING:** The wall plug socket is used as a disconnection device and should remain readily accessible.
- **WARNING:** The batteries shall not be exposed to excessive heat such as direct sunlight or fire.
- Although every effort is made to maintain the accuracy of the manual, due to continuous product development, some variation from the manual is possible.
- The availability of features and settings may vary depending on the input source and method of connection.
- Although every effort is made to maintain the accuracy of the manual, due to continuous product development, some variation from the manual is possible.
- The availability of features and settings may vary depending on the input source and method of connection.
- The available resolutions and refresh rates may be limited by the capabilities and/or settings of the source device.

 AT FULL VOLUME, PROLONGED LISTENING MAY DAMAGE THE USER'S HEARING.		
 <p>This warning sign is to warn of dangerous voltage inside the product.</p>	<div style="border: 2px solid black; padding: 5px; text-align: center;"> CAUTION <small>RISK OF ELECTRIC SHOCK, DO NOT OPEN</small> </div> <p>CAUTION: To reduce the risk of electric shock, DO NOT remove the cover (or back). No user serviceable parts inside. Refer servicing to qualified service personnel.</p>	 <p>This warning sign is to alert you of important instructions accompanying the product.</p>

WHAT'S INCLUDED



MONITOR

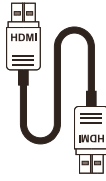

HDMI



Screws (CM4*26) x 5

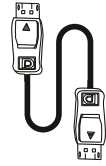

DP CABLE

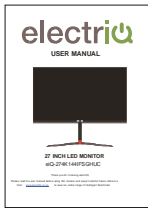

TYPE-C CABLE

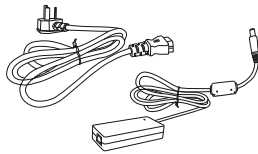

POWER SUPPLY



Screws (KM4*12) x 3

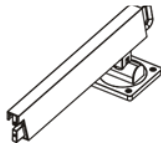

STAND (UPRIGHT SECTION)



STAND BASE

STAND INSTALLATION

1. Open the package, take out the Styrofoam and place it on a horizontal table.

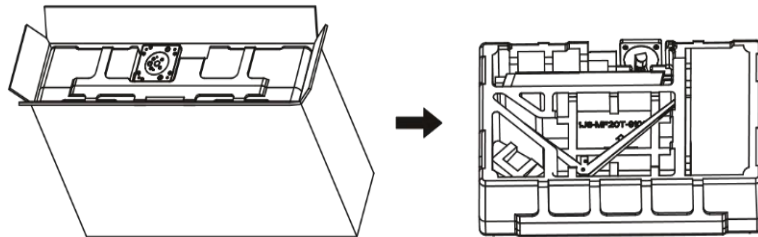

2. Remove the upper foam, remove the monitor from the film bag, and place the display on the lower foam.

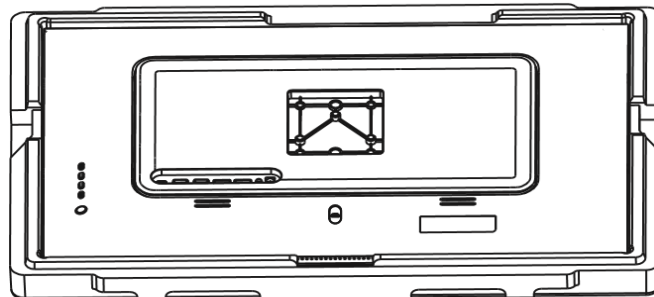

3. Take out stem and base, Lock them with 2pcs KM4*12mm screws.
(Screws are in the accessory bag, 1pcs buffer)

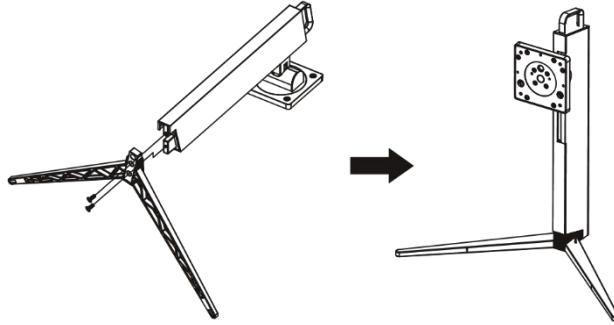

4. Insert the stem to the slot of back cover, them lock them with 4pcs CM4*26mm screws.
(Screws are in the accessory bag, 1pcs buffer)

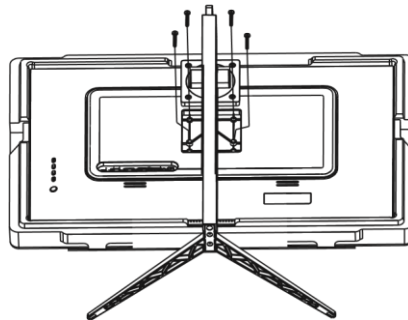

5. Hold the stand by hand and stand up the machine (Note: During the process of standing up the monitor, please do not pinch the screen directly with your hand to prevent the screen from breaking)

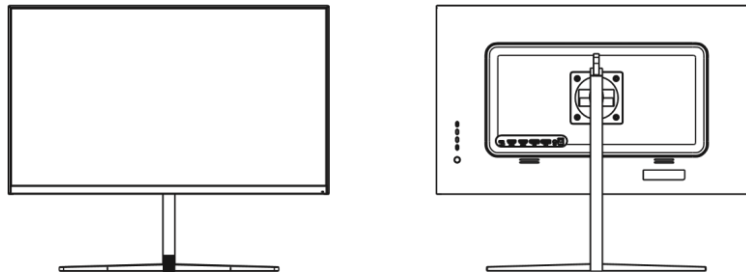

NOTES:

- Due to the heavy weight and dimensions of the LCD screens and their fragile nature, we recommend that they are unpacked and assembled by 2 people.
- electriQ and its distributors and dealers are not liable or responsible for damage or injury caused by improper installation, improper use or failure to observe these safety instructions. In such cases any guarantee will expire.
- The stand can be removed from the rear of the monitor by pressing the quick release button on the rear of the monitor.

CONNECTIONS AVAILABLE ON THE MONITOR

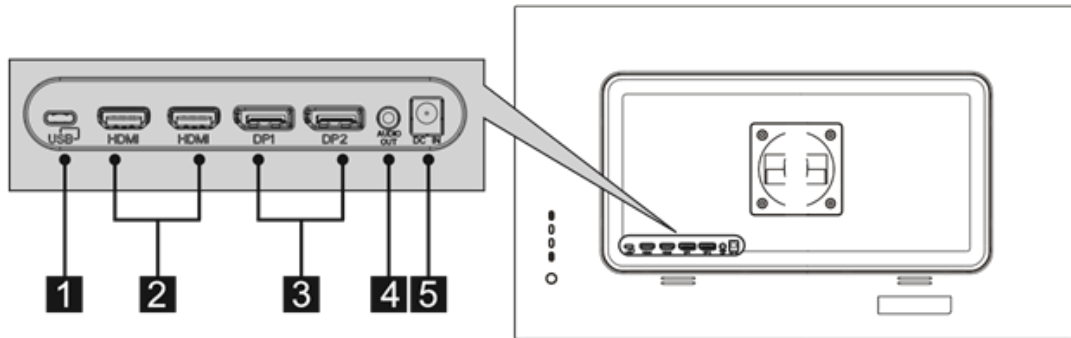

1. TYPE-C
2. HDMI 2.0 x 2
3. DISPLAY PORT 1.4
4. AUDIO OUT
5. POWER

GETTING STARTED

MONITOR CONTROLS

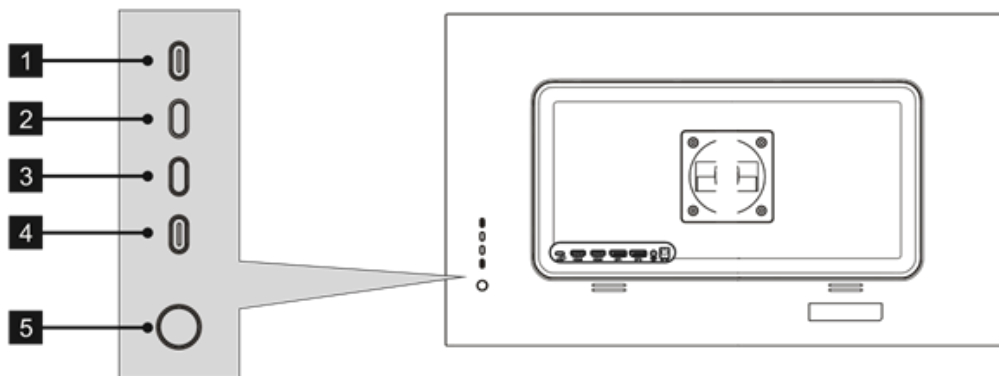

M Select signal source or Exit the menu

▲ Go Up within the Main Menu or increase the value of the selected item

▼ Go Down within the Main Menu or decrease the value of the selected item

E Enter the Main OSD Menu and Select submenu

⏻ Turn the monitor on or Off

INDICATOR LIGHT

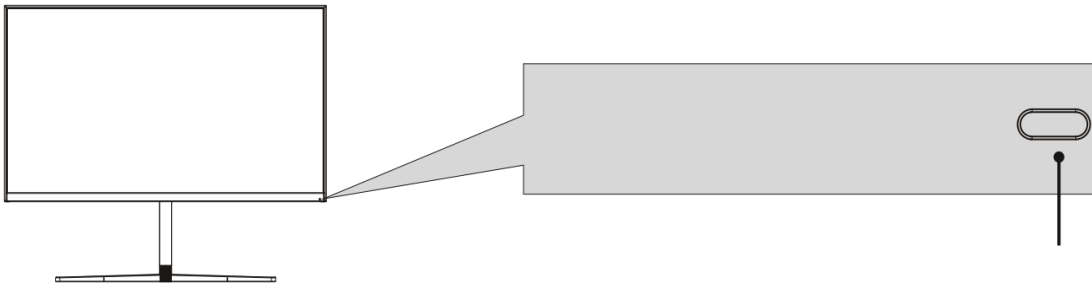

Solid White light indicates power is on and the monitor is operating normally. Flashing White light indicates no video source, no horizontal or vertical signal has been detected. Please ensure your computer is on and all video cables are fully inserted and/or connected.

SHORTCUT BUTTONS

The monitor includes one touch options to access common settings.

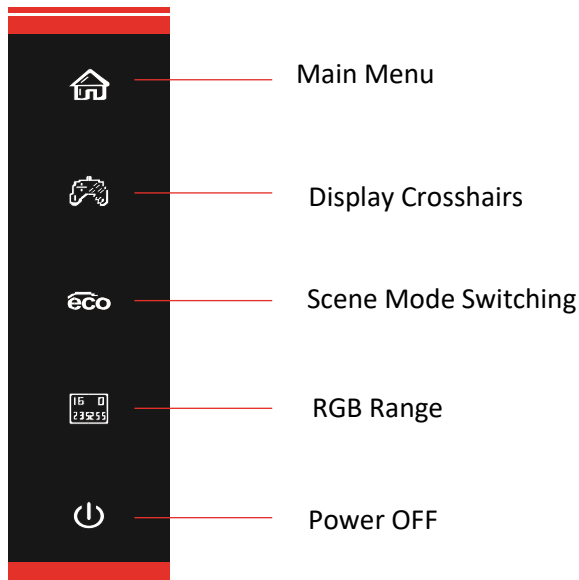

MENU OPTIONS

The menu for the monitor can be accessed by pressing the menu button on the control panel. This menu is separated into the following sub menus: Input source, Brightness/Contrast, Colour Settings, Picture Quality Settings, Display, Audio, Multi-Window, OSD (On screen display), and other. Details of each menu can be found in the following section.

OSD MENU INPUT SOURCE

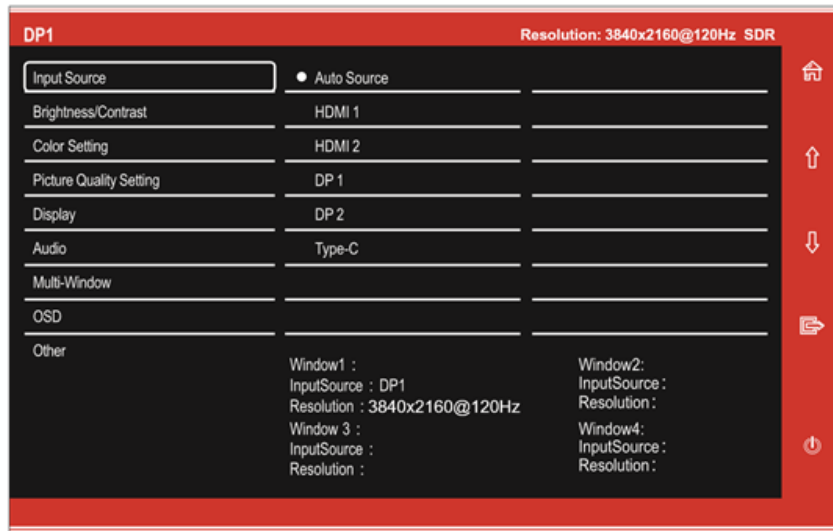

Signal | Switch the signal input or select the source. HDMI1, HDMI2, DP1, DP2, Type-C.

BRIGHTNESS/CONTRAST

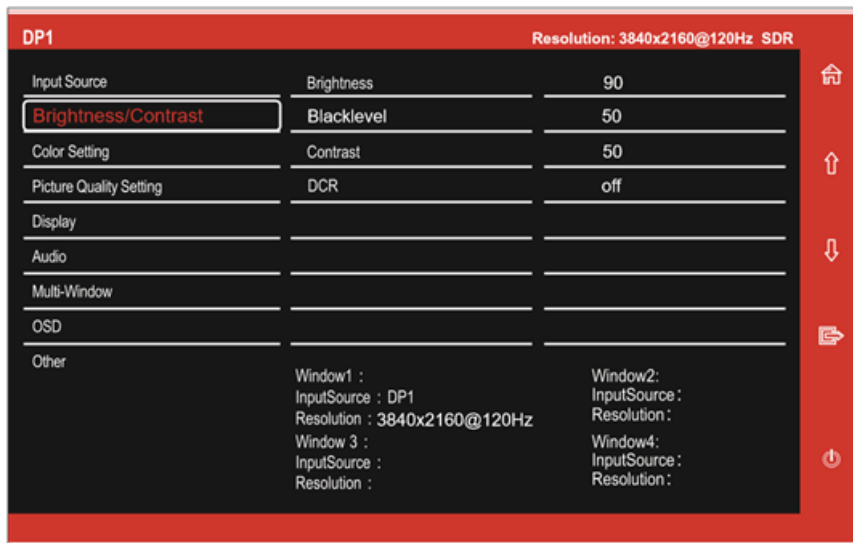

Brightness	Adjust the brightness of the display between 0 and 100.
Black level	Adjust the black level of the display between 0 and 100.
Contrast	Adjust the contrast of the display between 0 and 100.
DCR	Turn the Dynamic Contrast Ratio Feature On or Off.

COLOUR SETTINGS

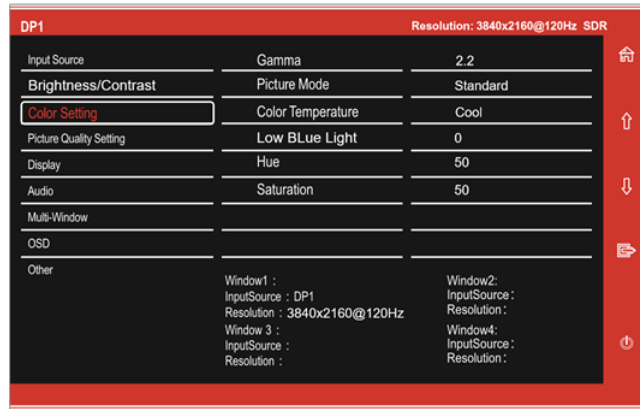

Gamma	Change the Gamma value for the display between 1.8, 2.0, 2.2, 2.4, 2.6
Picture Mode	Change the picture mode between Standard, Photo, Movie, Game, FPS and RTS.
Colour Temperature	Change the Colour Temperature of the display to Normal, Warm, Cool or User. When the User Mode is selected, the Red, Green, and Blue values can be adjusted independently between 0 and 100.
Low Blue Light	Change the blue light emitted by the display between 0 and 100.
Hue	Change the Hue value between 0 and 100.
Saturation	Change the Saturation of the display between 0 and 100.

PICTURE QUALITY SETTINGS



Sharpness	Change the display Sharpness between 0 and 100.
Response Time	Turn the Response Over Drive feature between Off, High, Middle or low
Noise Reduction	Adjust the level of Noise Reduction between Low, Medium, High, or Off.
Dynamic Luminance Control	Turn the Dynamic Luminance Control feature On or Off.
MPRT	Turn the motion blur on or off.

DISPLAY

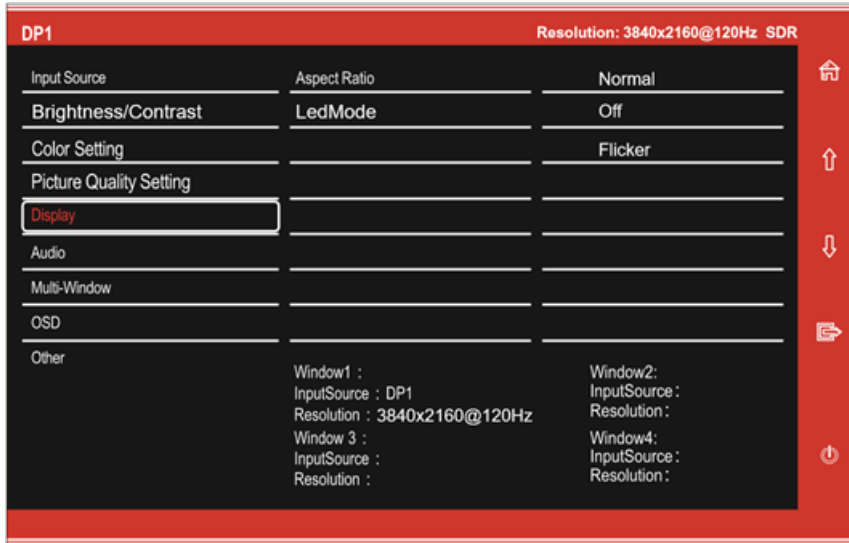

Aspect Ratio	Change the image aspect ratio to Wide Screen. 4:3 Auto. 1:1
LED Mode	Turn on the LED backlight. Normal, Off, Flicker.

AUDIO

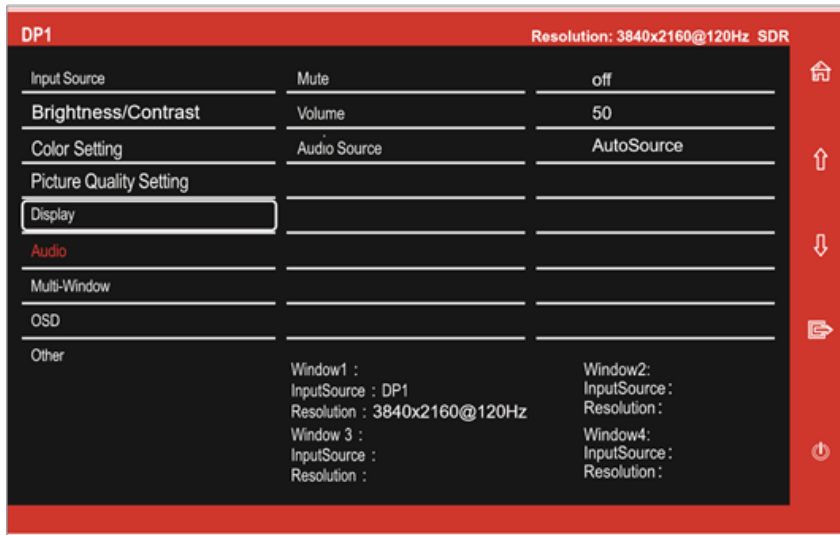

Mute	Turn On and off to mute and unmute the audio output.
Volume	Adjust the output volume between 0 and 100.
Audio Source	Choose which source the audio is output from Type-C, DP, or HDMI.

MULTI-WINDOW

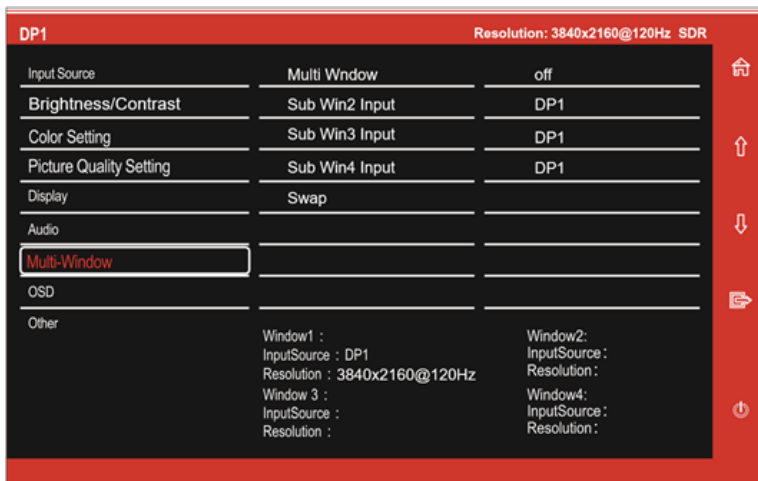

Multi-Window	Choose the different formats of multi window display between Off, Picture in Picture (PIP) and Picture by Picture (PBP 2Win)
Sub Win2 Input	Choose the source of the second window between DP1, DP2 and HDMI 1 HDMI 2.
Sub Win3 Input	Choose the source of the second window between DP1, DP2 and HDMI 1 HDMI 2.
Sub Win4 Input	Choose the source of the second window between DP1,DP2 and HDMI 1 HDMI 2.
SWAP	Swap the Primary and Secondary inputs on screen.

OSD



Language	Change the OSD Menu display language between English, Chinese, Korean, Russian, Spanish, Japanese and French.
OSD H Position	Change the horizontal position of the OSD Menu between 0 and 100.
OSD V Position	Change the vertical position of the OSD Menu between 0 and 100.
OSD Transparency	Change the transparency value of the OSD Menu between 0 and 100.
OSD Time Out	Change how long the OSD Menu is on before it atomically exits.
OSD Rotation	Change the OSD Rotation Normal,90,180,270

OTHER

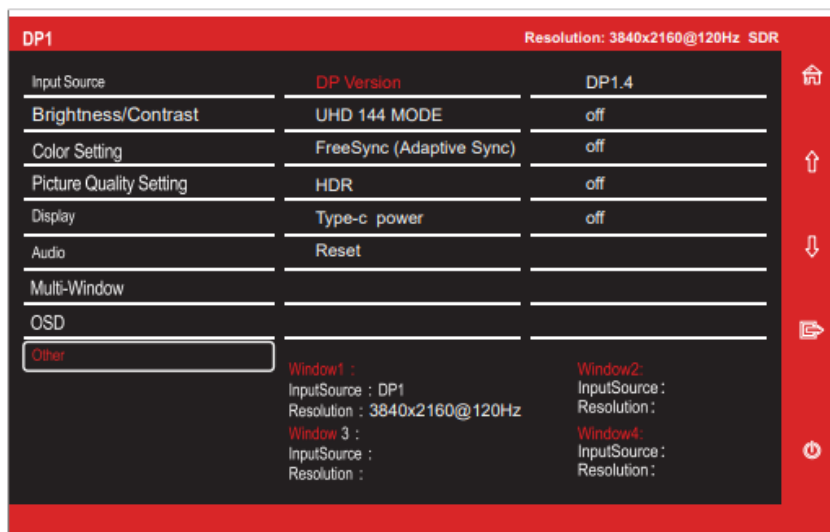

DP Version	Change the DP version
UHD 144 MODE	Turn the UHD 144 MODE on/off
FreeSync (Adaptive Sync)	Turn Free Sync On or Off. HDR: Turn HDR On (Requires HDMI 2.0 input).
Type C Power	When the TYPE-C cable is plugged into the monitor, if the TYPE-C switch is turned on, the window will not pop up; if the TYPE-C switch is turned off, the pop-up window selection switch will be displayed.
HDR	Turn the HDR on or off.
Reset	Restore factory default settings.

TECHNICAL SPECIFICATION

Product Model	eiQ-274K144IFS GHUCA	
Screen Size	27" Diagonal	
Panel Type	IPS	
Aspect Ratio	16:9	
Power Supply	DC 19V= 3.42A	
Power Consumption	42W(Typical)	
Dimensions	620 X 40 X 365 mm	
Net / Gross Weight	6.31 kg / 8.29kg	
Picture	Maximum Resolution	3840 X 2160
	Brightness	350cd/m ²
	Static Contrast	1000:1
	Response Time	7ms
	Viewing Angle (H/V)	178° / 178°
Terminals	USB Input	N/A
	HDMI Input	HDMI 2.0 x2
	Display Port Input	DP 1.4 x2
	Type-c	Type-c x1
	Audio Output	X1 (Headphone Socket)
	Remote Control	2m Maximum operating distance
Working Temperature	0°C - 40°C	
Working Humidity	10% - 85% Non-condensing	
Speaker Specifications	4Ω/3W	

TROUBLESHOOTING

Problem	Solution
No power	Insert the plug securely into the power outlet.
No picture	Ensure that the equipment is connected properly.
	Ensure the correct input is selected.
Buttons on the monitor don't do anything	Disconnect the power plug and then reconnect it. (The unit may not be operating properly due to lightning, static, or other factors.)
Noise or other interference	Electronic equipment near the unit may be causing interference. Relocate the unit or move the equipment.

ENVIRONMENTAL PROTECTION



Recycling facilities are now available for all customers at which you can deposit your old electrical products. Customers will be able to take any old electrical equipment to participating civic amenity sites run by their local councils. Please remember that this equipment will be further handled during the recycling process, so please be considerate when depositing your equipment. Please contact the local council for details of your local household waste recycling centers

electriQ UK SUPPORT

www.electriQ.co.uk/support

Call: 0330 390 3061

Office hours: 9AM - 5PM Monday to Friday

www.electriQ.co.uk

Unit J6, Lowfields Business Park
Lowfields Way, Elland
West Yorkshire, HX5 9DA