

electriQ

NutriMagIQ Premium Blender **USER MANUAL**

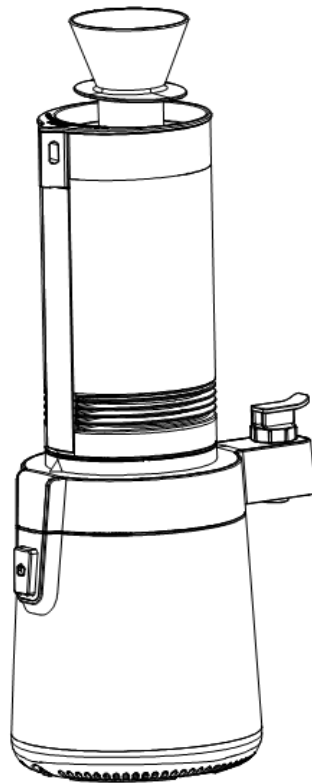

Thank you for choosing **ElectriQ**
Please read this user manual before using this blender
and keep it safe for future reference.
Visit our page www.electriQ.co.uk for our entire range of Intelligent Electricals

Contents

Features	3
Safety Instructions	4
Package content and parts	7
Quick reference guide	8
Assembly	9
Controls and Operation	12
Operation tips	14
Ingredients preparation	16
Fruits and Vegetables Nutrition Tables	17
Cleaning and Maintenance	20
Troubleshooting	22
Recipes	23

FEATURES

NutriMagIQ is a Premium Blender with unique grinding technique for smoother blends

Great for creating luscious smoothies, whole fibre juicing, soup making or use as protein shaker

Smart tap conveniently dispenses drinks into glasses or sport bottles

Unique recirculation system ensure the ingredients are processed and mixed equally without heat accumulation

Ultimate slow blender at only 3,000 RPM: quiet DC motor and low rotation speed to retain nutrients for healthier drinks

Create soups from cold or hot ingredients

Easy to use controls

BPA free container

High pressure self-cleaning function allows washing the unit with ease between different jobs or before storage

Super strong commercial grade steel blade and unique grinding plates

Advanced safety system will shield the motor from overheating ensuring long continuous operation

Note: Due to continuous product development, products may not exactly correspond to the illustrations in this manual.

SAFETY INSTRUCTIONS

Important

- Carefully read the instructions before operating the unit
- This blender has been tested and is safe to use. However, as with any electrical appliances - use it with care.
- This appliance is for indoor and domestic use only.
- Rating: This unit must be only connected to a 220-240 V / 50 Hz earthed outlet. Always check the rating label against your electrical supply. Do not use with an extension lead or overload the socket
- If you are in any doubt about the suitability of your electrical supply have it checked and, if necessary, retested by a qualified electrician.
- Do not let power cord hang over edge of table or counter or in contact with hot surface, including stoves or hobs.
- Disconnect the power plug from socket before dismantling, assembling or cleaning.
- Do not clean the unit by spraying it or immersing it in water.
- Never operate this appliance if the cord or plug is damaged. Ensure the power cord is not stretched or exposed to sharp object/edges.
- Do not pull the mains cable to disconnect the mains plug from the socket.
- Do not use the appliance if any part or any accessory is damaged or defective.
- A damaged supply cord or plug should be replaced by the manufacturer or a qualified electrician in order to avoid a hazard.
- Avoid touching any moving parts of the appliance. Keep hands and utensils out of container while blending to reduce the risk of severe injury to persons or damage to the blender. A rubber scraper or spatula may be used but only when the jug is removed from the base. Handle or remove blade and blade assembly from the container with extreme care to avoid injury.
- Never insert fingers, or any other objects apart from the food tamper through the feeder hole. Only the tamper provided must be used. Tamper has a special feed through / anti-splash design if you need to add more ingredients to the food mix.
- This appliance is not intended for use by persons (including children) with reduced physical, sensory or mental capabilities. It is also not intended for use by those with a lack of experience and knowledge, unless they have been given supervision or instruction concerning the use of the appliance by a person responsible for their safety. Do not leave children unsupervised with this appliance.
- Any service other than regular cleaning should be only performed by an authorized service representative. Failure to comply could result in a voided warranty.
- Do not use the appliance for any other purposes than its intended use.
- Always place the unit on a dry, hard, flat and stable surface. Do not use on carpet or soft table cloth as this could impede hot air dispersal. Do not shake while is in use.
- Do not use the appliance in places with high humidity (>80%RH)
- Do not immerse the appliance in water or other liquids. If the appliance is immersed in water or other liquids by mistake, do not touch the appliance with your hands. Immediately remove the mains plug from the wall socket. If the appliance is immersed in water or other liquids, discard it.

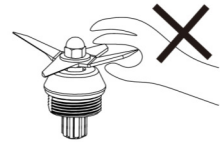

Unit Safety Protection and Performance Tips

- Never switch on the unit before you intend to use it.
- Make sure the jug and the blade assembly is correctly mounted and placed on the appliance body.
- Do not place the jug on the appliance body without screwing in the lid and make sure the pressure release valve at the top of the lid is open. Only seal with the green silicon stopper while using it part of the optional grab and go kit. Do not unscrew the lid from jug before removing it from the appliance body or switching the appliance off. Always operate blender with lid screwed on. The lid should only be removed after stopping the blender when adding ingredients or when using the supplied tamper.
- Do not remove the jug / container before the motor completely stops.

- Do not run it empty or fill more than the maximum 1000 ml advised level as this could cause damage to the appliance.
- If temperature of the liquid is more than 50°C (e.g. processing soups or hot drinks) never fill more than ¾ of the jug (750 ml) and only run the appliance with the lid in place. Do not pour hot liquid in the blender when motor works. When removing the lid after blending hot liquids do not lean over the blender jug and keep hands and other exposed skin away from the lid opening to prevent possible burns.
- Never attempt to operate with damaged blades. Replace the blades assembly.
- Do not over fill, use hard ingredients or very large piece. Don not use ice cubes if they are not covered with water or liquid. Use maximum 3-4 ice cubes while blending. This appliance is not intended to be an ice crusher.
- Always clean the jug immediately after use. Use water for most efficiently and safe way of cleaning and blend until the jugs is clear. Empty the jug and repeat operation with clean water.
- Leave clear space beneath and around the base of the appliance to permit proper air circulation. Vents and openings on the bottom of the product are designed for ventilation ensuring reliable motor operation and over-heating. Clean the unit regularly and store covered to prevent dust entering inside of the unit. Never obstruct and keep away from kitchen towers, newspapers, napkins, place mats etc.

IMPORTANT:

This product is a class 2 double insulated appliance and therefore an earth connection is not needed. Do not replace the power cord or plug. Only a qualified electrician or the service centre can perform this operation.

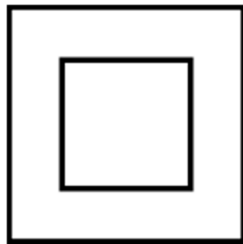

CAUTION: DO NOT CONNECT EITHER WIRE TO THE EARTH TERMINAL IN THE PLUG WHICH IS MARKED E OR WITH THE EARTH SYMBOL OR COLOURED GREEN OR GREEN AND YELLOW.

Wait until the motor completely stops before removing the lid or tamper.

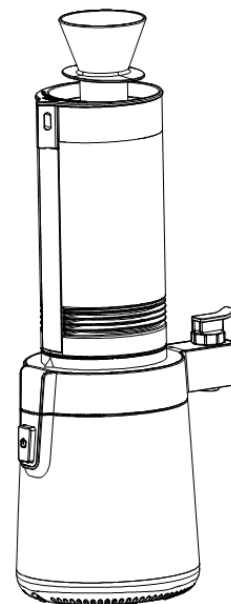

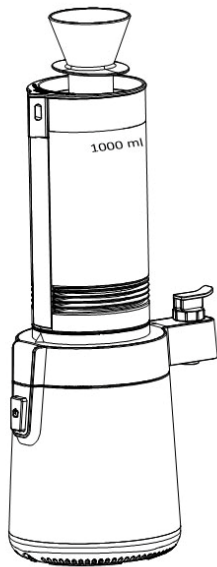

Only fill the jug to maximum indicator. When making hot soup or using hot liquid only use $\frac{3}{4}$ of the jug capacity as hot liquids expand during processing.

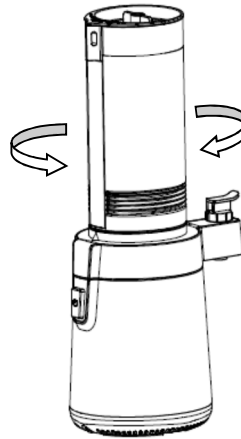

Before starting the appliance check if is correctly assembled and the mark on the jug matches the mark on the body.

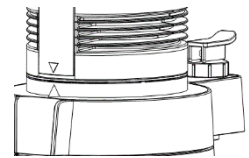

Make sure the lid is screwed in place, twist the lid handle clockwise to lock in.

Keep the pressure release valve open in the lid while operating the unit and dispensing the juice.

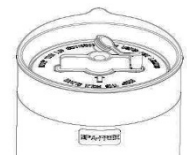

When you need to use the tamper, only open the lid and insert the tamper when the motor is stopped. When finished with the tamper screw back the lid.

Do not open the lid while unit is in operation. Due its special design you can use the tamper to add ingredients of stir the food mixture. Tamper has anti-splash guard. Do not raise the tamper above the jug rim while motor is in operation. Do not use the tamper while hot liquid is blended.



Make sure no liquid goes on the bottom of the grinding plate / dispenser assembly as this will affect the lifespan of the product. If such occurrence use a paper tissue or kitchen towel to remove liquid as soon as possible.



This product has over current protection. If the motor overheats due to overload the appliance will stop. Unplug the machine and let it rest for few minutes.

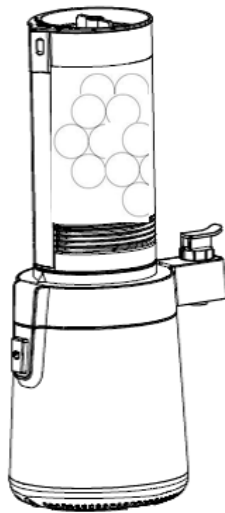

Do not leave the working appliance unattended at anytime. Keep unsupervised children away from the plugged appliance.



Allow at least 20 cm gap around the unit while in operation to allow free air flow around the air inlet and outlet.

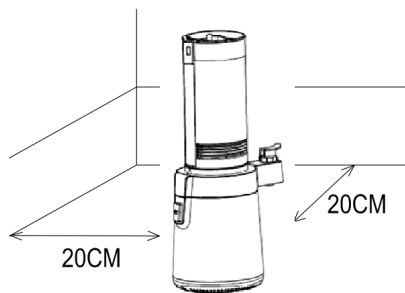

After use, unplug from power socket and store the unit in a dry place. The appliance is equipped with a long cord. Store the unused portion underneath.

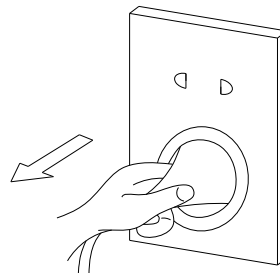

PACKAGE CONTENTS

1x Container Jug

1 x Container lid with pressure release valve

1 x Blade assembly with grinder plate and dispenser

1 x Tamper

1x Base / Motor body

1x User Manual

Account for all parts before disposing packing. Safely dispose of all plastic bags and other packaging components. They may be potentially dangerous to children.

Quick Reference Guide

NutriMagiQ

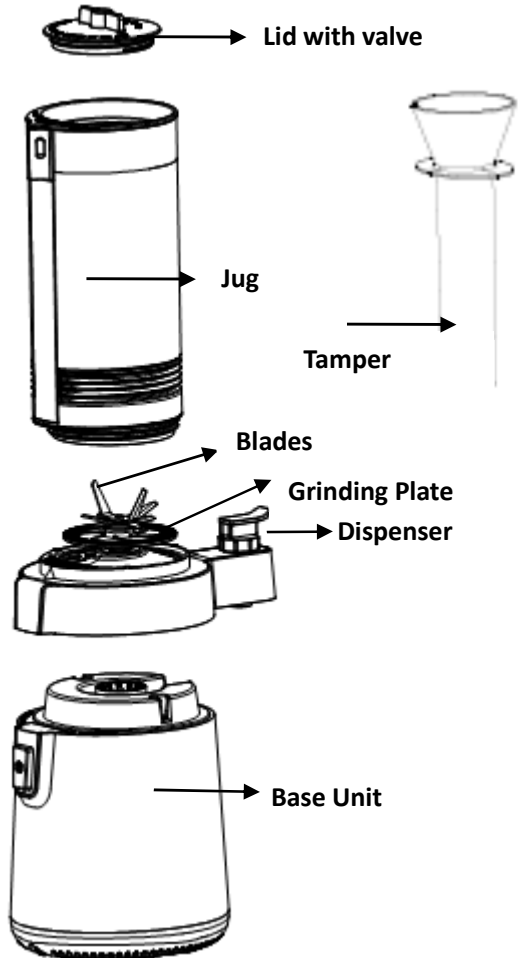

1. Tamper
2. Lid
3. Container / Jug
4. Blade assembly
5. Grinding plate
6. Drinks dispenser
7. Body / Motor base
8. ON / OFF switch

Grab and Go kit (Optional)

String (A)

Container base (B)

Carry pouch (C)

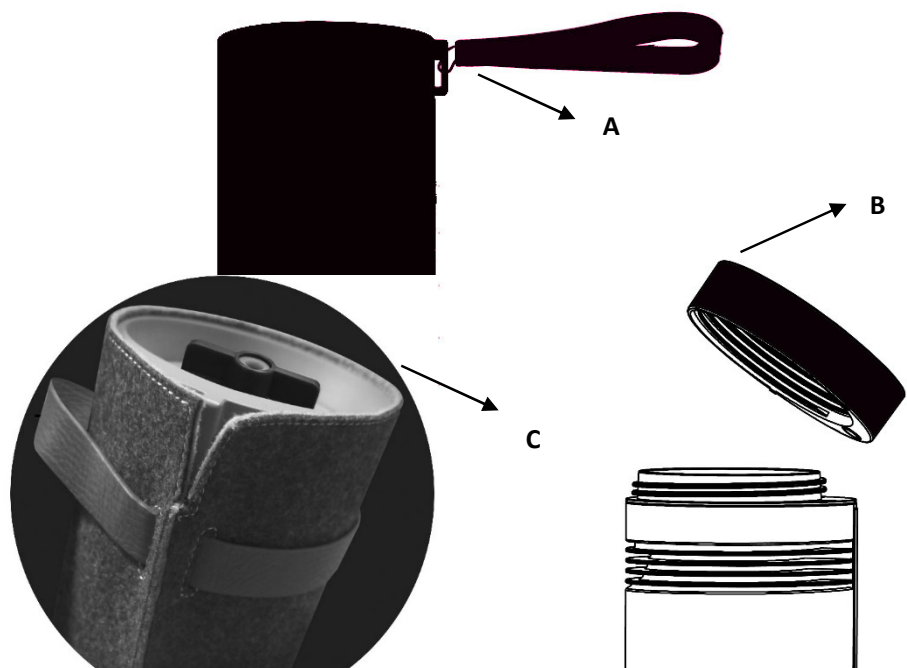

Initial Use

Preparation

- Clean the appliance and accessories before first use
- Wash the container / jug and tamper before use. Also refer to the section "**Cleaning and maintenance**"

Assembly and Operation

Before assembly or disassembly, switch off the appliance, remove the mains plug from the wall socket and wait until the appliance has cooled down.

This appliance has a built-in safety lock; this feature ensures that you can only switch on the appliance if you positioned the jugs / containers correctly on the motor base. When assembled correctly, the built-in safety lock will be unlocked.

Assembling the NutriMagiQ

Before you assemble the appliance, ensure that the power cord is unplugged.

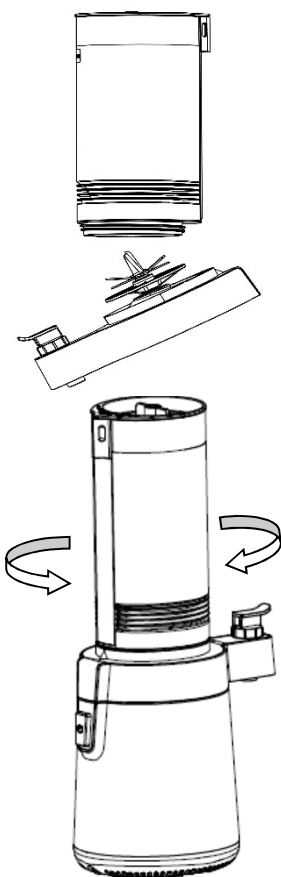

1. Place the motor base on a flat dry surface such as a countertop. Leave at least 20 cm space around the unit

2. Place the jug on the top of blade assembly / dispenser and twist clockwise until the marks align

3. Place the jug / container on the top of the motor base with the lid cover on with the dispenser opposite the power button

4. Plug the unit on to a main socket and turn the socket on

5. Make sure unit is off before opening the lid and adding ingredients.

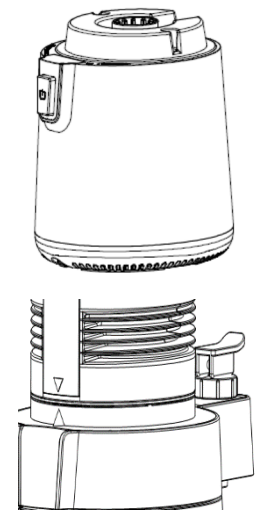

Notes: Please never place a jug / container on the motor base without the lid cover on as power on button may be activated. We recommend first adding ingredients in the jug than placing

the container on the blender base. Remove the lid only if adding extra ingredients or using the tamper. Only remove the lid plug while the motor is stopped. Never lift the jug from motor base or remove the lid before the motor is completely stopped.

Your appliance is supplied with a BPA free **wet jug** that is able to perform all operations from processing liquids e.g. blending, soup making, whole fibre juice and smoothie making, nut milks to sauces, purees, pesto.

Do not grind grains, cereals, coffee or other dry ingredients. This is a wet blender only. Do not attempt to blend any hard ingredients and also ensure the ingredients are well covered with water.

To **disassemble** reverse the assembly operation. See Cleaning and Maintenance section of this user manual.

Assembly instruction for Grab and Go Kit (Optional)

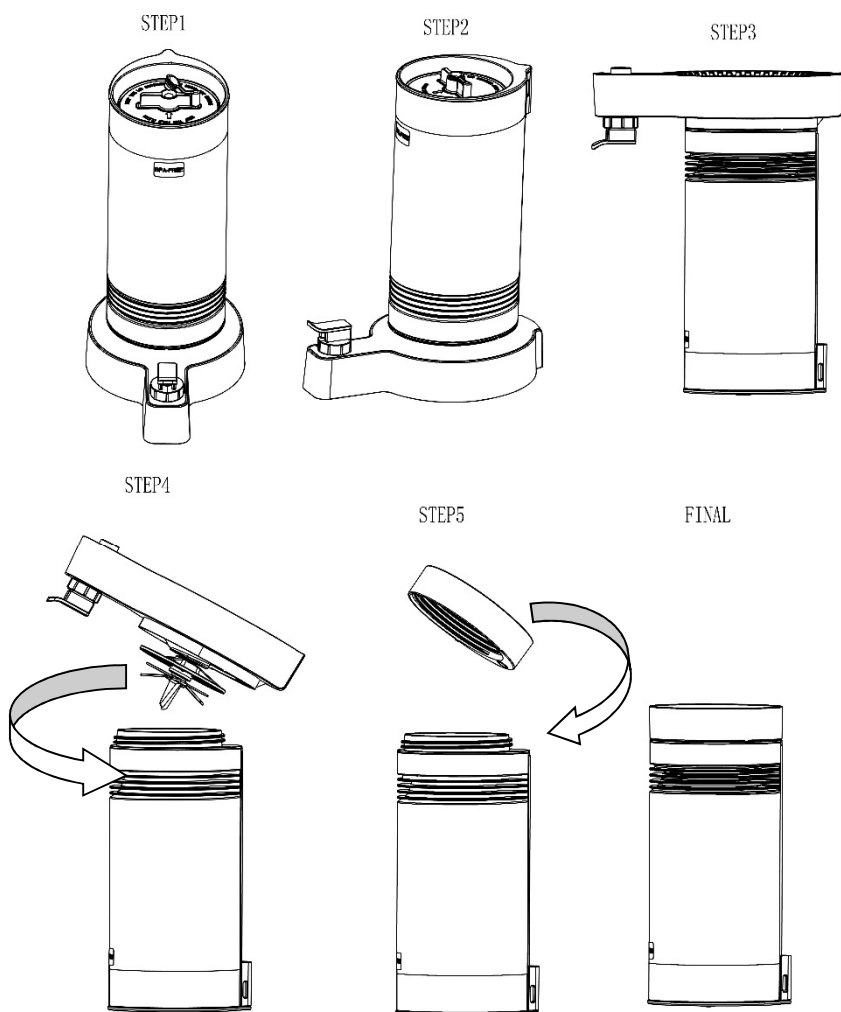

1. When blending is finished remove the container including the blade assembly and dispenser from the motor base.
2. Insert the silicon plug into the pressure release valve
3. Turn the unit upside down
4. Unscrew the blade assembly rotating it anti-clockwise
5. Attach the container base and screw it clockwise.
6. Turn around the container, attach the string and transport in the pouch.

Your NutriMagiQ blender has a smart tap able to dispense drinks directly into glasses or sport bottles. However the Grab and Go optional kit transforms the unit in an easy to use portable drink container with a capacity over 1 litres great for active people on the go.

Once your drink was prepared and Grab and Go container assembled you can open the lid to drink or you can add 3-4 cubes of ice at the top to keep you drink cool. You can ring directly from the cup or you can use a straw.

Your Grab and Go kit is BPA free so is safe to store the drink during the day. Rinse the cup when empty and follow thorough cleaning procedure once the cup is reassembled on the NutrimagiQ body.

ON/OFF Switch:

Push down the switch and the unit is turned **ON**

Push the switch again and the unit is turned **OFF**

Your NutrimagiQ is not the usual blender but a slow blender that generates less heat while mixing better the ingredients. Your NutriMagiQ will make creamier, smoother and tastier smoothies, whole fibre juices or soups without adding additional sugar or fat. Many high power fast spinning traditional blenders creates a motion that spins the ingredients into the blade area. This means that the ingredients from the base of the jug will go intense processing and get heated more than the rest. Also the raw nutrients and antioxidants are destroyed in this process.

Due to its slower rotation, special grinding plate design and recirculating folding motion, the NutriMagiQ creates fine and light drinks without overheating. The liquid is pushed up and aerated with colder air ensuring better mix and heat dissipation. Microbubbles are also folded into the drinks for better taste and finer texture. You will also notice that inedible parts of the fruits such the peeps of raspberries or strawberries are filtered in the jug and the result is a higher quality, more digestible drink. The smoothies and drinks processed by your NutriMagiQ will container more vitamins, calcium and minerals than the drinks produced by a classic high spinning blender. The alchemical transmutation of simple ingredients in amazing drinks is what makes NutriMagiQ really special.

Function	Description
Whole Fibre Juice	<p>When juicing your traditional juicer will extract the juice from the fruits or vegetables leaving a lot of pulp behind. While juicing will give you a quick release of energy and the ingredients are passed much quicker into your blood stream being more soluble, all the good fibre is wasted. The whole fibre juice produced by the NutriMagiQ is the best of the both. The whole fruit juice is palatable and has more dietary fibre and vitamins. 1-3 minutes of blending should suffice.</p> <p>Recipe: 1 peeled orange, a handful of raspberries, 1 apple, ¼ celery stick, ¼ unwaxed lime with rind, small piece of peeled ginger, 3 ice cubes, ½ glass of water</p> <p>Add the ingredients in the above order. Almost cover the ingredients with water. Work the blender for 1-3 minutes or until smooth enough for your taste and dispense in glasses or bottles while still motor works</p>
Smoothies	<p>NutrimagiQ is ideal for smoothies and shakes. The appliance needs to blend for 1-2 minutes to make delicious smoothie drinks. Depending on the ice cubes size and the hardness of fruit you may use the tamper to stir.</p> <p>Recipe: 1 peeled banana, 1 large peach vanilla from ½ pod, 3 ice cubes, water or milk to cover the ingredients.</p> <p>Work the blender for 1-2 minutes or until smooth enough for your taste and dispense in glasses or bottles while still motor works</p>
Soups	<p>Your NutriMagiQ can make hot vegetables soups from cold or hot ingredients. Working for 10-15 minutes is enough to process and heat cold liquid to steaming hot soups. The blender will transfer the friction heat into the liquid heating without any heating elements. 5-7 minutes will produce hot soup at 50-60°C which is ideal for raw diets</p> <p>You can also use boiling water to get soups cooked in less than 5 minutes.</p> <p>Recipe: Season and roast 4 large tomatoes, 1 medium pepper, 1 clove of garlic for about 4 minutes in top grill tray. Place in the roasted ingredients in the blender jug. Add a cube of stock or ½ teaspoon of salt, one chopped celery stick, spring onion and parsley and 2 glasses of water. Blend for 10-15 minutes until piping hot. If you want chunky soups add extra ingredients at the end via tamper and only blend for 20-30 seconds. Release some of the liquid before adding more ingredients.</p>
Nut milk	<p>You can make nut milks from almonds, hazelnuts, soya beans with your NutriMagiq. Soak the nuts in water for minimum 10 hours before making nut milk. Strain the nuts and place in the blend; cover with 2 glasses of water (1/2 litre) to 200 grams of dry nuts. Add 2 table spoons of maple syrup (may use agave syrup, raw honey) and a pinch of salt. Blend for 4-5 minutes. Optional you can use a strainer or a milk bag to filter further the liquid.</p>

Hot Chocolate	Your NutriMagiq will do smooth hot chocolate from cold ingredients. Blend 2 glasses of milk, 2 tablespoons of cocoa powder, 2 teaspoons of sugar, agave or maple syrup for 5-7 minutes until hot and smooth. Dispense while blender motor is working. Can replace the milk with nut milk and/ or cocoa powder with shaved dark chocolate.
Protein Shakes	You NutriMagiQ can easily blend meal replacement shakes. Oatmeal, bananas, avocado are all good bases for your protein shake. You can follow the recipes provided by your protein manufacturer or be creative. Recipe: 1 scoop of chocolate protein, 1 banana, 1/2 cup of oatmeal, 3 ice cubes, 2 cups or skimmed milk, ½ tablespoon of vanilla paste. Add the ingredients to the jug in this order and blend for 1-2 minutes until smooth. Dispense directly in the glass or sport bottle. Can replace the vanilla paste with other flavours (e.g. fresh mint)
Clean	After finish the food processing you can clean easily the machine if you put some cold or tepid water inside the jug, close the top lid and blend for 1-2 minutes. Empty the water via dispenser in a mug or over the sink and repeat the operation until the jug is clean. We advise only to use a droplet of washing up liquid and fill only to 2/3 if you for a thorough cleaning. You can also wash the jug by adding lemon juice or mild vinegar to water and not using cleaning products. Once cleaned, empty the jug and turn it upside down on a kitchen towel or cloth. Unit can be disassembled if not in use for a longer period. If any residue is left on the wall of the jug place under the running water and rinse into the sink

Operation and tips

Never overfill the jugs. Never start the appliance on empty. Use the correcting timing according to the results you are trying to achieve or the recipes you prepare.

When following a recipe always follow the ingredients advised order and ensure the ingredients are chopped to no more than 2-3 cm in length. Never use more than 5 ice cubes and always cover the ingredients with water.

You can make whole fibre juices, soups, smoothies, shakes, protein shakes, sauces, hot drinks and nut milks.

When processing ingredients always follow this order from bottom to top:

- leafy greens at the bottom
- soft fruits / peeled citrus in the middle
- hard ingredients chopped and flavours / spices at top
- ice cubes above
- water to cover up to max line or 750 ml if hot liquid or hot drink is made.

1-3 minutes of blending are enough for whole fibre juices, smoothies or shakes.

Up to 5 minutes will pulverised and homogenize nut milks.

5-7 minutes for raw vegetable soups at 50-60°C or steaming soups if boiling water is used instead of cold.

10-15 minutes of processing vegetables, herbs, spices and cold water is enough to create piping hot soups from cold ingredients. The friction heat is transferred to the liquid creating delicious hot drinks. Hot chocolate or dairy free alternative can be created from cold ingredients as well. To create a smooth soup with less froth just add 1 or 2 spoons of olive oil. This will improve taste and help with the absorption of nutrients.

If ingredients do not circulates inside the jug; the appliance may be overloaded, had trapped air or the mixture may be too solid. Stop the unit and insert the tamper through the lid opening and help the mixture to move. Do not exceed the processing time unnecessary. If mixture still does not circulate and recipe allows add small amounts of liquid to help circulation. You can use again the tamper to help the mixture circulating.

If processing **hot liquids** never load to maximum markings as there is further liquid expansion; we advise to fill only 3/4 of the jug when using hot liquids. Release some of the liquid via the dispenser as hot liquids gradually increase their volume. Be cautious when removing the lid as hot liquids may release steam or splash and is risk of scalding.

When creating juices, smoothies, cocktails or other cold drinks add ice cubes to keep the mixture cold. This will allow a smother crispier texture, ensuring better taste.

When making juice or smoothies use ice cubes or cover with enough water.

When juicing or creating nut milks you may want to use a strainer, milk bag (filtration bag) or a muslin cloth to filter the mixture if you want a liquid without any residues. We advise to soak the nuts for at least 8 hours. Keep in the fridge while soaking.

When adding ingredients via the tamper make sure the appliance motor stopped.

Twist the lid back into its place before restart food processing.

Always load the jug in the order listed in the recipe: liquids and soft foods first with dry ingredients and/or ice cubes at the end. Following this will ensure the best machine performance and improved taste. The NutriMagiQ is able to create smooth combinations blended to perfection.

When processing personal recipes as a general rule liquids are to be added first than solids (e.g. water first, milk, oil, then banana, strawberries, then almonds, then ice etc.)

Using the tamper

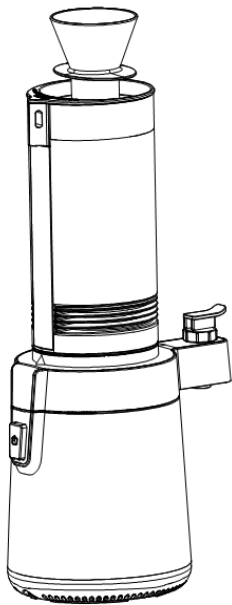

Your appliance is supplied with a tamper that allows to process thicker mixtures.

Using the tamper accelerates the processing time, helps the circulation of mixture, helps eliminating air pockets, ensures the mixture homogenize well and can be processed by the blades.

While the machine is in operation use the tamper through the lid opening. Add new ingredient via the tamper opening and press them into the blades making sure the food is moved in the jug.

Never use any other tamper than the one provided with the appliance. The tamper length and the anti-splash disk (next to the top of the tamper) is designed to prevent the tamper bottom from hitting the blades. Never fill the jug for more than 2/3 full when using tamper during blending. If adding more ingredients via tamper release some liquid via the dispenser.

Do not engage the tamper for more than 30-40 seconds at a time as this may cause overheating. Stop for at least one minute before continuing. If the food does not move there may be air trapped inside the mixture and the tamper may need to be moved circularly around the sides of the jug.

Ingredients

Apples, Pears
Artichokes hearts
Avocado
Banana
Beets
Berries
Broccoli and cauliflower
Cabbage
Cacao Beans and Nibs
Canned beans
Canned Green Beans
Canned Lentils
Celery sticks
Cherries
Chia Seeds
Citrus
Cooked Rice
Courgettes
Dried Apricots and prunes
Dry Lentils
Figs
Flax
Fresh Apricots, Plums and Peaches
Garlic
Ginger
Green Beans and peas
Kiwi
Lettuce
Mango
Mixed greens
Nuts
Oats
Papaya
Peppers
Pineapple
Pumpkin, Sunflower seeds
Quinoa
Sesame Seeds
Spinach
Sprouts
Sweet Potato
Tomato
Watermelon / Gallia Mellon
Wheat Bran

Preparation

Rinse, slice in 4 remove core, seeds and stem, leave skin on
Rinse and strain from jar can
Cut in 1/2 remove pit and scrap flesh from skin
Peel and break in 3-4 sections
Rinse and peel, cut in small cubes
Rinse
Rinse, remove brown spots and spread in pieces
Rinse and cut in 2-3 cm wedges
Blend as they are
Drain and Rinse
Drain and Rinse
Rinse
Break stalks, cut sticks in 2-3 cm pieces
Rinse and remove stem and pit
Blend as is
peel skin, remove seeds
Blend as is
Peel, rinse, cut in chunks leave skin on or organic
Cut in half, remove pit
Cook and drain
Rinse and remove stem
Blend as is
Remove pits if included
Separate cloves, remove skin
Peel, cut in small cubes
Blend as is
Peel skin, remove seeds
Remove brown leaves and rinse
Rinse, peel, slice flesh from pit, cut in cubes
Rinse, wash, remove brown or old leaves
Soak for milks, if in shell remove shell
As is or cooked
Rinse, scoop out the seeds, scoop the flesh
Cut in 1/2, remove seeds
Peel, remove core, cute in cubes
Blend as is
Cooked only, blend s is
Blend as is
Rinse and remove old / brown leaves
Rinse
Rinse, steam or cook
Cook or fresh, cut in quarters if fresh
Cut and remove the flesh
Blend as is

Refer to the following tables for the nutritional values of a wide range of fruits and vegetables.

Vegetables

Nutrition Facts

Raw, edible weight portion. Percent Daily Values (%DV) are based on a 2,000 calorie diet.

Vegetables Serving Size (gram weight/ ounce weight)	Calories	Calori es from Fat	Total Fat		Sodium		Potassium		Total Carbo-hydrate		Dietary Fiber		Sugars (g)	Protein (g)	Vitamin A (%DV)	Vitamin C (%DV)	Calcium (%DV)	Iron (%DV)
			(g)	(%DV)	(mg)	(%DV)	(mg)	(%DV)	(g)	(%DV)	(g)	(%DV)						
Asparagus 5 spears (93 g/3.3 oz)	20	0	0	0	0	0	230	7	4	1	2	8	2	2	10	15	2	2
Bell Pepper 1 medium (148 g/5.3 oz)	25	0	0	0	40	2	220	6	6	2	2	8	4	1	4	190	2	4
Broccoli 1 medium stalk (148 g/5.3 oz)	45	0	0.5	1	80	3	460	13	8	3	3	12	2	4	6	220	6	6
Carrot 1 carrot, 7" long, 1 1/4" diameter (78 g/2.8 oz)	30	0	0	0	60	3	250	7	7	2	2	8	5	1	110	10	2	2
Cauliflower 1/6 medium head (99 g/3.5 oz)	25	0	0	0	30	1	270	8	5	2	2	8	2	2	0	100	2	2
Celery 2 medium stalks (110 g/3.9 oz)	15	0	0	0	115	5	260	7	4	1	2	8	2	0	10	15	4	2
Cucumber 1/3 medium (99 g/3.5 oz)	10	0	0	0	0	0	140	4	2	1	1	4	1	1	4	10	2	2
Green (Snap) Beans 3/4 cup cut (83 g/3.0 oz)	20	0	0	0	0	0	200	6	5	2	3	12	2	1	4	10	4	2
Green Cabbage 1/12 medium head (84 g/3.0 oz)	25	0	0	0	20	1	190	5	5	2	2	8	3	1	0	70	4	2
Green Onion 1/4 cup chopped (25 g/0.9 oz)	10	0	0	0	10	0	70	2	2	1	1	4	1	0	2	8	2	2
Iceberg Lettuce 1/6 medium head (89 g/3.2 oz)	10	0	0	0	10	0	125	4	2	1	1	4	2	1	6	6	2	2
Leaf Lettuce 1 1/2 cups shredded (85 g/3.0 oz)	15	0	0	0	35	1	170	5	2	1	1	4	1	1	130	6	2	4
Mushrooms 5 medium (84 g/3.0 oz)	20	0	0	0	15	0	300	9	3	1	1	4	0	3	0	2	0	2
Onion 1 medium (148 g/5.3 oz)	45	0	0	0	5	0	190	5	11	4	3	12	9	1	0	20	4	4
Potato 1 medium (148 g/5.3 oz)	110	0	0	0	0	0	620	18	26	9	2	8	1	3	0	45	2	6

Radishes 7 radishes (85 g/3.0 oz)	10	0	0	0	55	2	190	5	3	1	1	4	2	0	0	30	2	2
Summer Squash 1/2 medium (98 g/3.5 oz)	20	0	0	0	0	0	260	7	4	1	2	8	2	1	6	30	2	2
Sweet Corn kernels from 1 medium ear (90 g/3.2 oz)	90	20	2.5	4	0	0	250	7	18	6	2	8	5	4	2	10	0	2
Sweet Potato 1 medium, 5" long, 2" diameter (130 g/4.6 oz)	100	0	0	0	70	3	440	13	23	8	4	16	7	2	120	30	4	4
Tomato 1 medium (148 g/5.3 oz)	25	0	0	0	20	1	340	10	5	2	1	4	3	1	20	40	2	4

Most vegetables provide negligible amounts of saturated fat, trans fat, and cholesterol.

Fruits

Nutrition Facts

Raw, edible weight portion. Percent Daily Values (%DV) are based on a 2,000 calorie diet.

Fruits Serving Size (gram weight/ ounce weight)	Calories	Calories from Fat	Total Fat		Sodium		Potassium		Total Carbo- hydrate		Dietary Fiber		Suga rs (g)	Prot ein (g)	Vita min A (%DV)	Vita min C (%DV)	Calci um (%DV)	Iron (%DV)
			(g)	(%D v)	(mg)	(%D v)	(mg)	(%D v)	(g)	(%D v)	(g)	(%D v)						
Apple 1 large (242 g/8 oz)	130	0	0	0	0	0	260	7	34	11	5	20	25	1	2	8	2	2
Avocado California, 1/5 medium (30 g/1.1 oz)	50	35	4.5	7	0	0	140	4	3	1	1	4	0	1	0	4	0	2
Banana 1 medium (126 g/4.5 oz)	110	0	0	0	0	0	450	13	30	10	3	12	19	1	2	15	0	2
Cantaloupe 1/4 medium (134 g/4.8 oz)	50	0	0	0	20	1	240	7	12	4	1	4	11	1	120	80	2	2
Grapefruit 1/2 medium (154 g/5.5 oz)	60	0	0	0	0	0	160	5	15	5	2	8	11	1	35	100	4	0
Grapes 3/4 cup (126 g/4.5 oz)	90	0	0	0	15	1	240	7	23	8	1	4	20	0	0	2	2	0
Honeydew Melon 1/10 medium melon (134 g/4.8 oz)	50	0	0	0	30	1	210	6	12	4	1	4	11	1	2	45	2	2
Kiwifruit 2 medium (148 g/5.3 oz)	90	10	1	2	0	0	450	13	20	7	4	16	13	1	2	240	4	2
Lemon 1 medium (58 g/2.1 oz)	15	0	0	0	0	0	75	2	5	2	2	8	2	0	0	40	2	0

Lime 1 medium (67 g/2.4 oz)	20	0	0	0	0	0	75	2	7	2	2	8	0	0	0	35	0	0
Nectarine 1 medium (140 g/5.0 oz)	60	5	0.5	1	0	0	250	7	15	5	2	8	11	1	8	15	0	2
Orange 1 medium (154 g/5.5 oz)	80	0	0	0	0	0	250	7	19	6	3	12	14	1	2	130	6	0
Peach 1 medium (147 g/5.3 oz)	60	0	0.5	1	0	0	230	7	15	5	2	8	13	1	6	15	0	2
Pear 1 medium (166 g/5.9 oz)	100	0	0	0	0	0	190	5	26	9	6	24	16	1	0	10	2	0
Pineapple 2 slices, 3" diameter, 3/4" thick (112 g/4 oz)	50	0	0	0	10	0	120	3	13	4	1	4	10	1	2	50	2	2
Plums 2 medium (151 g/5.4 oz)	70	0	0	0	0	0	230	7	19	6	2	8	16	1	8	10	0	2
Strawberries 8 medium (147 g/5.3 oz)	50	0	0	0	0	0	170	5	11	4	2	8	8	1	0	160	2	2
Sweet Cherries 21 cherries; 1 cup (140 g/5.0 oz)	100	0	0	0	0	0	350	10	26	9	1	4	16	1	2	15	2	2
Tangerine 1 medium (109 g/3.9 oz)	50	0	0	0	0	0	160	5	13	4	2	8	9	1	6	45	4	0
Watermelon 1/18 medium melon; 2 cups diced pieces (280 g/10.0 oz)	80	0	0	0	0	0	270	8	21	7	1	4	20	1	30	25	2	4

Most fruits provide negligible amounts of saturated fat, *trans* fat, and cholesterol; avocados provide 0.5 g of saturated fat per ounce.

Provided by <http://www.fda.gov>

Cleaning and maintenance

The appliance must be cleaned immediately after each use. Regular maintenance of your appliance will keep it safe and in proper operational order.

The lid, lid plug and tamper can be cleaned using hot water under the tap or in a dishwasher top rack.

Make sure that the bottom of the jug is not immersed in water. If water is reaching the bottom of the jugs please use kitchen towel or dry cloth to immediately dry it. Prolonged water contact may cause damage and will reduce the life of the appliance.

Notes:

Before cleaning or maintenance, switch off the appliance, remove the mains plug from the wall socket and wait until the appliance has cooled down.

- Do not immerse the appliance in water or other liquids.
- Do not use aggressive or abrasive cleaning agents to clean the appliance.
- Do not use sharp objects to clean the appliance.
- Do not sterilize any accessories with water with a temperature higher than 70 °C or in the microwave to prevent deformation or damage. The materials of all parts that come into contact with food must be clean and hygienic.
- Regularly check the appliance for possible damage and stop using it if any damage.
- Clean the outside of the appliance with a soft, damp cloth. Thoroughly dry the outside of the appliance with a clean, dry cloth.
- Clean the accessories
- Disassemble the appliance.
- Clean the accessories in soapy water. Rinse the accessories under running water. Thoroughly dry the accessories.

The easy way to clean the jugs between different operations is to use the procedure bellow

Standard Cleaning (also use before first use)

1. Fill the jug 2/3 with warm water and add a droplet only washing detergent to the container.
2. Lock the jug lid in place before starting the appliance
3. Blend for 1-2 minutes. The detergent may expand into a foam. Release some of content via dispenser if expanded too much in the jug.
4. Leave the jug to rest for 1-2 minutes with the cleaning liquid as this will help the stuck mixture to be released.
5. Repeat 3 for as many times as needed
6. Turn off the machine and empty the container. Refill with clean hot water to the maximum mark and process again. Rinse thoroughly when finished.
7. Drain the jug and let it dry on a kitchen towel

Deep Cleaning

1. Follow normal Cleaning instructions above.
2. When finished, fill the container with hot water to the mark and add half glass of vinegar or lemon juice.
3. Clean for 25 seconds twice then turn off the machine and allowing mixture to stand in the container for an additional 3-4 minutes each time.
4. Dispose the mixture and allow container to dry.
8. Do not rinse after deep cleaning.

Tips:

If the jug is used with the optional Grab and Go kit or cannot be cleaned immediately after use for any reasons, fill it with hot soapy water and leave them to soak. We do not recommend to leave this for more than few hours as blade maybe affected. When not in use store your appliance and all its accessories and instruction manual in a safe and dry place.

Troubleshooting

Fault	Cause	Troubleshooting
Not starting	Improper installation.	Make sure the appliance is fully plugged and correctly assembled. Reinstall the appliance following assembly instructions
Burnt smell coming from unit and / or the motor appears to struggle / cut out during use	Normal for first time use. Should reduce over the time. Air Circulation is blocked and unit is overheating Food does not circulate, air bubbles may form	Make sure that air vents are left clean and air can circulate Use tamper to make food circulate Add extra liquid to the mixture Return the appliance to retailer for repair or exchange only if the appliance will not restart after pressing the reset button underneath.
Stopping during use	Motor control protection The tamper is used for too long	Disconnect power, remove the surplus from jug and then reassemble. Use less force on the tamper Restart after pausing 10-15 minutes
Appliance is shaking and moving	The machine is not on a perfect horizontal surface	Place the machine on a stable surface
Appliance is spilling out liquid	The jug is overloaded over the maximum markings level The jug lid may not be properly installed	Release part of the mixture via the dispenser. Resit the lid and secure it on the top of the jug.

Note: Your ElectriQ NutriMagiQ has automatic overcurrent safety switch off designed to protect the motor and enhance the life span of the appliance and give you peace of mind. When this feature is activated this will cause the motor to shut down. Prior and after this motor may emit a light odour but this is normal. Rest the unit for 10-15 minutes and then resume normal operation.

For any other faults please contact the service centre.

Recipes

Wash all fruit and vegetables well before processing. Only remove the skin from the fruit and vegetables when advised to do so. Citrus and hard skin fruits or vegetables must be peeled. Try to avoid cutting and peeling fruit and vegetables too far in advance of the actual processing as this will reduce the nutrient levels.

Your appliance is compatible other nutriblenders but can do much more.

<https://www.nutriliving.com/recipes> is a good place to start looking for recipes also you can find video recipes on youtube.

Pink Whole Pineapple Juice

Preparation: 4 minutes • processing: 2 minutes • makes: 500 ml (2 servings)

250g fresh ripe pineapple

Deskinned without core cut in chunks

Hand of raspberries (can replace with mint leaves for green juice)

4 ice cubes

1 glass of water

1. Put all the ingredients into the NutriMagiQ jug in the order listed and secure the lid.

2. Process for 1-2 minutes or until the desired consistency and smoothness is reached.

3. if too sweet add extra ice

4. Serve from dispenser while the motor is still spinning

Note: Inedible residue may be left of the jug. Dispose while cleaning.

Red Smoothie

Preparation: 5 minutes • processing: 2-3 minutes • makes: 500ml

150g red grapes

100g strawberries or raspberries

1 banana, peeled

4 ice cubes, ½ glass of water

1. Put all the ingredients into the NutriMagiQ jug in the order listed and secure the lid.

2. Process for 2-3 minutes or until the desired consistency and smoothness is reached

Notes: if using frozen fruits, do not add ice but increase the water to 1 full glass. Raspberry seeds may collect on the jug wall. Dispose while cleaning

Morning Boost

Preparation: 5 minutes • processing: 2-3 minute • makes: 500ml

200g blueberries

2 teaspoons of Chia seeds (can replace with 5 almonds)

1 tablespoon of cocoa powder

2 bananas, peeled

4 ice cubes

1 teaspoon of maple or agave syrup

½ glass of water

1. Put all the ingredients into the NutriMagiQ jug in the order listed and secure the lid.

2. Process for 2-3 minutes or until the desired consistency and smoothness is reached

Notes: if using frozen fruits, do not add ice increase the water to 1 glass. Can replace cocoa powder with shaved dark chocolate

Maxi Fit Shaker

Preparation: 5 minutes • processing: 2-3 minutes • makes: 500ml

2 cups of spinach

1 banana, peeled

4 tablespoons of protein powder (can replace with the flesh from a ripe avocado)

4 ice cubes, 1 glass of water (can replaced with coconut milk, almond milk or skimmed milk)

1. Put all the ingredients into the NutriMagiQ jug in the order listed and secure the lid.

2. Process for 2-3 minutes or until the desired consistency and smoothness is reached

Tomato Soup

Preparation: 5 minutes • processing: 5-15 minutes seconds • makes: 750 g (3-4 servings)

2 cups of water (500 g) (can boil first)

3 large tomatoes (can roast)

1 onion/ shallot/spring onion

1 celery stick

1/2 carrot sliced in chunks

1 red capsicum (pepper) sweet or hot (½)

1 handful cashews nuts

1 handful of basil (with stalk)

1 garlic clove

1 tsp of sea-salt or one vegetable stock cube

1 tsp of balsamic vinegar (optional)

1 tbsp or 2 of high quality cold pressed olive oil (optional)

1. Put all the ingredients into the NutriMagiQ jug in the order listed and secure the lid

2. Blend for 5-7 minutes if using boiled water. If using cold water and blending for 5-7 minutes you can have soup appropriate for raw diet prepared at 50-60 °C with increase concentration of vitamins and nutrients.

Blend for 10 -15 minutes until the desired temperature is obtained for steaming hot smooth and silky soups.

Notes: Use tamper to effectively move the ingredients into the blades if required whilst

processing. If chunky texture is needed add some vegetables at the end and blend for 10-15 seconds only. Garnish with Basil leaves and serve with croutons.

Experiment with any combination of vegetables to personalize your soups.

Mean Green Soup

Preparation: 5 minutes • processing: 5-20 minutes seconds • makes: 750 g (3-4 servings)

2 cups of water (500 g) (can boil first)

2 cups of spinach

2 spring onions (or one shallot)

1 celery stick

1 green large capsicum (pepper) sweet or hot (½)

1 handful cashews nuts

1 pinch of cumin (optional)

1 handful of coriander or parsley (can blend at the end)

1 tsp of sea-salt or one vegetable stock cube

1 tbsp or 2 of high quality cold pressed olive oil (optional)

1. Put all the ingredients into the NutriMagiQ jug in the order listed and secure the lid
2. Blend for 5-7 minutes if using boiled water. If using cold water and blending for 5-7 minutes you can have soup appropriate for raw diet prepared at 50-60°C with increase concentration of vitamins and nutrients.

Blend for 10 -15 minutes until the desired temperature is obtained for steaming hot smooth and silky soups.

Notes: Use tamper to effectively move the ingredients into the blades if required whilst processing. If chunky texture is needed add some vegetables at the end and blend for 10-15 seconds only. Garnish with parleys leaves and serve with croutons and yoghurt or sour cream dollop. Experiment with any combination of green vegetables to personalize your soups.

Raw Nuts Milk

Preparation: 5 minutes • processing: 5-7 minutes seconds • makes: 570 g (2-3 servings)

Makes about a pint of nuts milk

200g raw almonds*

300 ml filtered water

4 ice cubes

Maple syrup (may use agave syrup, raw honey)

Pinch of salt (optional); 1 tsp vanilla extract (optional)

1. Soak raw almonds for at least 10 hours. Best keep them in a glass jug in refrigerator.
2. Drain the water and replace with 300 ml clean filtered or bottled water

3. Put all the ingredients into the NutriMagiQ jug in the order listed and secure the lid.

4. Process for 5-7 minutes or until the desired consistency and smoothness is reached

6. May use a strainer or a cheese cloth (jam muslin cloth) to filter the remaining pulp from the milk

8. Place the nut milk into a glass bottle or a jug. Mix well before drinking. Keep refrigerated and use within 2 working days

Notes: Can replace with soaked hazelnuts, soya beans etc.

Hot Berry Chocolate

Preparation: 5 minutes • processing: 5-7 minute • makes: 750ml – 3 servings

100g blueberries

¼ cup of oats

2 tablespoon of cocoa powder

1 banana, peeled

1-2 teaspoon of maple or agave syrup

2 glasses of water or skimmed milk

1. Put all the ingredients into the NutriMagiQ jug in the order listed and secure the lid.

2. Process for 5-7 minutes or until the desired consistency, temperature and smoothness is reached

Notes: Can replace cocoa powder with shaved chocolate or cocoa nibs

Detox Max

Preparation: 4 minutes • processing: 3 minutes • makes: 750 ml (3 servings)

1 cup of raspberries

½ small avocado

½ celery stick cut in chunks

1 small beetroot peeled and sliced

1 tablespoon of coconut butter or flaxseed oil

4 ice cubes

1 glass of water or coconut water

2 tablespoons of maple or agave syrup

1. Put all the ingredients into the NutriMagiQ jug in the order listed and secure the lid.

2. Process for 2-3 minutes or until the desired consistency and smoothness is reached.

3. If too sweet add extra ice

4. Serve from dispenser while the motor is still spinning

Note: Inedible residue may be left of the jug. Dispose while cleaning the jug

Technical Specification

Model: NUTRIMAGIQ

Voltage: 220-240V ~ 50/60Hz

Power Input: 200 W Speed: 3,000 RPM

Wet Jug: BPA Free (1 litre)

Size: 35 x 20.5 x 30.5 cm

Weight: 3.3 kgs



Disposal: Do not dispose this product as unsorted waste. Collection of such waste must be handled separately as special treatment is necessary. Recycling facilities are now available for all customers at which you can deposit your old electrical products. Customers will be able to take any old electrical equipment to participating civic amenity sites run by their local councils. Please remember that this equipment will be further handled during the recycling process, so please be considerate when depositing your equipment. Please contact the local council for details of your local household waste recycling centres.

ElectriQ UK SUPPORT

www.ElectriQ.co.uk/support

Please, for your own convenience, make these simple checks before calling the service line.

If the unit still fails to operate call: 0871 620 1057 or complete the online form

1. Is the unit plugged into the mains?
2. Is the fuse OK? Is the unit correctly assembled?
3. Have you followed the troubleshooting guide?
4. Switch the unit off. Restart the unit.

Office hours: 9AM - 5PM Monday to Friday

www.ElectriQ.co.uk

Unit 2, The Nursery

Berristow Lane

South Normanton

Derbyshire, DE55 2FX

electriQ

