

User Manual

GETTING STARTED? EASY.



ZDLN1512

EN User Manual
Dishwasher

ZANUSSI

VISIT OUR WEBSITE FOR:



Get usage advice, brochures, trouble shooter, service and repair information:

www.zanussi.com/support

SAFETY INFORMATION

Before the installation and use of the appliance, carefully read the supplied instructions. The manufacturer is not responsible for any injuries or damage that are the result of incorrect installation or usage. Always keep the instructions in a safe and accessible location for future reference.

CHILDREN AND VULNERABLE PEOPLE SAFETY

- This appliance can be used by children aged from 8 years and above and persons with reduced physical, sensory or mental capabilities or lack of experience and knowledge if they have been given supervision or instruction concerning the use of the appliance in a safe way and understand the hazards involved.
- Children between 3 and 8 years of age and persons with very extensive and complex disabilities shall be kept away from the appliance unless continuously supervised.
- Children of less than 3 years of age should be kept away from the appliance unless continuously supervised.
- Do not let children play with the appliance.
- Keep detergents away from children.
- Keep children and pets away from the appliance when the door is open.
- Children shall not carry out cleaning and user maintenance of the appliance without supervision.

GENERAL SAFETY

- This appliance is intended to be used in household and similar applications such as:
 - farm houses; staff kitchen areas in shops, offices and other working environments;
 - by clients in hotels, motels, bed & breakfast and other residential type environments.

- Do not change the specification of this appliance.
- The operating water pressure (minimum and maximum) must be between 0.5 (0.05) / 8 (0.8) bar (MPa)
- Follow the maximum number of 13 place settings.
- If the supply cord is damaged, it must be replaced by the manufacturer, its Authorised Service Centre or similarly qualified persons in order to avoid a hazard.
- Put the cutlery in the cutlery basket with the sharp ends pointing down or put them in the cutlery drawer in a horizontal position with the sharp edges down.
- Do not leave the appliance with the open door unattended to avoid stepping accidentally onto it.
- Before any maintenance operation, deactivate the appliance and disconnect the mains plug from the socket.
- Do not use high pressure water sprays and/or steam to clean the appliance.
- If the appliance has ventilation openings in the base, they must not be covered e.g. by a carpet.
- The appliance is to be connected to the water mains using the new supplied hose-sets. Old hose sets must not be reused.

SAFETY INSTRUCTIONS

INSTALLATION



WARNING! Only a qualified person must install this appliance.

- Remove all the packaging.
- Do not install or use a damaged appliance.
- Do not use the appliance before installing it in the built-in structure due to safety manner.
- Follow the installation instructions supplied with the appliance.
- Always take care when moving the appliance as it is heavy. Always use safety gloves and enclosed footwear.
- Do not install or use the appliance where the temperature is less than 0 °C.
- Install the appliance in a safe and suitable place that meets installation requirements.



www.youtube.com/electrolux
www.youtube.com/aeg

How to install your 60 cm
Dishwasher Sliding Hinge



ELECTRICAL CONNECTION



WARNING! Risk of fire and electric shock.

- The appliance must be earthed.
- Make sure that the parameters on the rating plate are compatible with the electrical ratings of the mains power supply.
- Always use a correctly installed shockproof socket.
- Do not use multi-plug adapters and extension cables.
- Make sure not to cause damage to the mains plug and to the mains cable. Should the mains

cable need to be replaced, this must be carried out by our Authorised Service Centre.

- Connect the mains plug to the mains socket only at the end of the installation. Make sure that there is access to the mains plug after the installation.
- Do not pull the mains cable to disconnect the appliance. Always pull the mains plug.
- This appliance is fitted with a 13 A mains plug. If it is necessary to change the mains plug fuse, use only a 13 A ASTA (BS 1362) fuse (UK and Ireland only).

WATER CONNECTION

- Do not cause damage to the water hoses.
- Before connection to new pipes, pipes not used for a long time, where repair work has been carried out or new devices fitted (water meters, etc.), let the water flow until it is clean and clear.
- Ensure that there are no visible water leaks during and after the first use of the appliance.
- If the water inlet hose is damaged, immediately close the water tap and disconnect the mains plug from the mains socket. Contact the Authorised Service Centre to replace the water inlet hose.

USE

- Do not put flammable products or items that are wet with flammable products in, near or on the appliance.
- Dishwasher detergents are dangerous. Follow the safety instructions on the detergent packaging.
- Do not drink and play with the water in the appliance.
- Do not remove the dishes from the appliance until the programme is complete. Some detergent may remain on the dishes.
- Do not store items or apply pressure on the open door of the appliance.

PRODUCT DESCRIPTION



The graphics below is just a general product overview. For more detailed information, refer to other chapters and/or documents provided with the appliance.

- The appliance can release hot steam if you open the door while a programme operates.

SERVICE

- To repair the appliance contact the Authorised Service Centre. Use original spare parts only.
- Please note that self-repair or non-professional repair can have safety consequences and might void the guarantee.
- The following spare parts will be available for 7 years after the model has been discontinued: motor, circulation and drain pump, heaters and heating elements, including heat pumps, piping and related equipment including hoses, valves, filters and aquastops, structural and interior parts related to door assemblies, printed circuit boards, electronic displays, pressure switches, thermostats and sensors, software and firmware including reset software. Please note that some of these spare parts are only available to professional repairers, and that not all spare parts are relevant for all models.
- The following spare parts will be available for 10 years after the model has been discontinued: door hinge and seals, other seals, spray arms, drain filters, interior racks and plastic peripherals such as baskets and lids.

DISPOSAL



WARNING! Risk of injury or suffocation.

- Disconnect the appliance from the mains supply.
- Cut off the mains cable and discard it.
- Remove the door catch to prevent children and pets to get closed in the appliance.

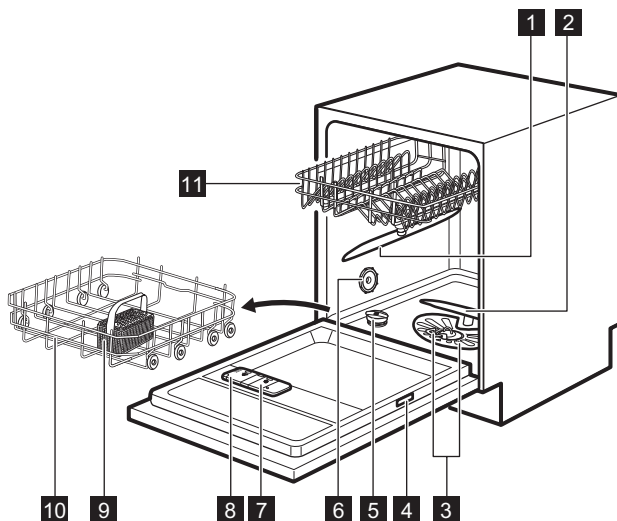

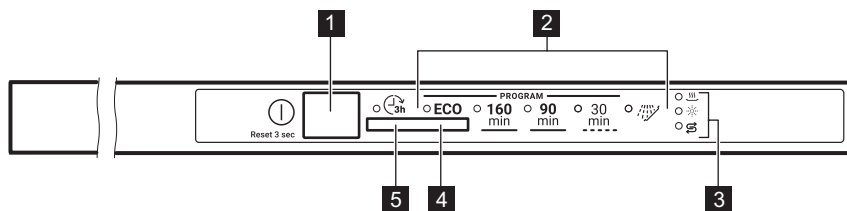

- | | |
|--------------------------|------------------------------|
| 1 Upper spray arm | 7 Rinse aid dispenser |
| 2 Lower spray arm | 8 Detergent dispenser |
| 3 Filters | 9 Cutlery basket |
| 4 Rating plate | 10 Lower basket |
| 5 Salt container | 11 Upper basket |
| 6 Air vent | |

CONTROL PANEL



- | | |
|-------------------------------------|-----------------------------|
| 1 On/Off button/Reset button | 4 Programme button |
| 2 Programme indicators | 5 Delay Start button |
| 3 Indicators | |

INDICATORS

Indicator	Description
	Drying phase indicator. It is on when you select a programme with the drying phase. It flashes when the drying phase operates.
	Salt indicator. It is on when the salt container needs refilling. It is always off while the programme operates.
	Rinse aid indicator. It is on when the rinse aid dispenser needs refilling. It is always off while the programme operates.

PROGRAMMES

The order of the programmes in the table may not reflect their sequence on the control panel.

Programme	Type of load	Degree of soil	Programme phases
ECO 1)	<ul style="list-style-type: none"> ▪ Crockery ▪ Cutlery ▪ Pots ▪ Pans 	<ul style="list-style-type: none"> ▪ Normal ▪ Lightly dried-on 	<ul style="list-style-type: none"> ▪ Prewash ▪ Wash 50 °C ▪ Intermediate rinse ▪ Final rinse 60 °C ▪ Drying ▪ AirDry
160 min	<ul style="list-style-type: none"> ▪ Crockery ▪ Cutlery ▪ Pots ▪ Pans 	<ul style="list-style-type: none"> ▪ Normal to heavy ▪ Dried-on 	<ul style="list-style-type: none"> ▪ Prewash ▪ Wash 60 °C ▪ Intermediate rinse ▪ Final rinse 60 °C ▪ Drying ▪ AirDry
90 min	<ul style="list-style-type: none"> ▪ Crockery ▪ Cutlery ▪ Pots ▪ Pans 	<ul style="list-style-type: none"> ▪ Normal ▪ Lightly dried-on 	<ul style="list-style-type: none"> ▪ Wash 60 °C ▪ Intermediate rinse ▪ Final rinse 55 °C ▪ Drying ▪ AirDry
30 min	<ul style="list-style-type: none"> ▪ Crockery ▪ Cutlery 	<ul style="list-style-type: none"> ▪ Fresh 	<ul style="list-style-type: none"> ▪ Wash 50 °C ▪ Intermediate rinse ▪ Final rinse 50 °C ▪ AirDry
 2)	<ul style="list-style-type: none"> ▪ All types of loads 	<ul style="list-style-type: none"> ▪ All degrees of soil 	<ul style="list-style-type: none"> ▪ Prewash

1) This is the longest programme offering the most efficient use of energy and water consumption for crockery and cutlery with normal soil. This is the standard programme for test institutes. This programme is used to assess compliance with the Ecodesign Commission Regulation (EU) 2019/2022.

2) This is a programme for rinsing off food remains from the dishes. It prevents odours forming in the appliance. Do not use detergent with this programme.

CONSUMPTION VALUES

Programme ¹⁾	Water (l)	Energy (kWh)	Duration (min)
ECO	9.9	1.039 ²⁾ /1.036 ³⁾	227
160 min	11.1 - 13.6	1.052 - 1.285	160
90 min	9.6 - 11.7	0.886 - 1.083	90
30 min	9.2 - 11.2	0.556 - 0.680	30
	3.4 - 4.2	0.012 - 0.015	15

1) The pressure and the temperature of the water, the variations of the mains supply, the options and the quantity of dishes can change the values.

2) In accordance with the 1016/2010 regulation

3) In accordance with the 2019/2022 regulation

Information for test institutes

To receive the necessary information for conducting performance tests (e.g. according to EN60436), send an email to:

info.test@dishwasher-production.com

In your request please include the product number code (PNC) found on the rating plate.

For any other questions regarding your dishwasher please refer to the service book provided with your appliance.

SETTINGS

PROGRAMME SELECTION MODE AND USER MODE

When the appliance is in programme selection mode it is possible to set a programme and to enter user mode.

Settings available in the user mode:

- The level of water softener according to the water hardness.
- Activation or deactivation of the rinse aid empty notification.
- Activation or deactivation of the acoustic signal for the end of a programme.
- Activation or deactivation of the AirDry.

As the appliance stores the saved settings, there is no need to configure it before every cycle.

How to set the programme selection mode

The appliance is in programme selection mode when the programme indicator **ECO** flashes. After activation, the appliance is in programme selection mode by default. If not, set the programme selection mode the following way:

Press and hold the programme button until the appliance is in programme selection mode.

How to enter user mode

Make sure the appliance is in programme selection mode.

To enter the user mode, press and hold the programme button until the indicator **ECO**

flashes and the indicators $\frac{160}{\text{min}}$, $\frac{90}{\text{min}}$ and $\frac{30}{\text{min}}$ are on.

THE WATER SOFTENER

The water softener removes minerals from the water supply, which would have a negative effect on the washing results and on the appliance.

The higher the content of these minerals, the harder your water is. Water hardness is measured in equivalent scales.

The water softener should be adjusted according to the hardness of the water in your area. Your local water authority can advise you on the hardness of the water in your area. It is important to set the right

level of the water softener to assure good washing results.

Water hardness

German degrees (°dH)	French degrees (°fH)	mmol/l	Clarke degrees	Water softener level
47 - 50	84 - 90	8.4 - 9.0	58 - 63	10
43 - 46	76 - 83	7.6 - 8.3	53 - 57	9
37 - 42	65 - 75	6.5 - 7.5	46 - 52	8
29 - 36	51 - 64	5.1 - 6.4	36 - 45	7
23 - 28	40 - 50	4.0 - 5.0	28 - 35	6
19 - 22	33 - 39	3.3 - 3.9	23 - 27	5 1)
15 - 18	26 - 32	2.6 - 3.2	18 - 22	4
11 - 14	19 - 25	1.9 - 2.5	13 - 17	3
4 - 10	7 - 18	0.7 - 1.8	5 - 12	2
<4	<7	<0.7	< 5	1 2)

1) Factory setting.

2) Do not use salt at this level.

Regardless of the type of detergent used, set the proper water hardness level to keep the salt refill indicator active.



Multi-tabs containing salt are not effective enough to soften hard water.

Regeneration process

For the correct water softener operation, the resin of the softener device needs to be regenerated regularly. This process is automatic and is the part of the normal dishwasher operation.

When the prescribed quantity of water (see values in the table) has been used since the previous regeneration process, a new regeneration process will be initiated between the final rinse and the programme end.

Water softener level	Amount of water (l)
1	250
2	100
3	62

Water softener level	Amount of water (l)
4	47
5	25
6	17
7	10
8	5
9	3
10	3

In case of the high water softener setting, it may occur also in the middle of the programme, before the rinse (twice during a programme). Regeneration initiation has no impact on the cycle duration, unless it occurs in the middle of a programme or at the end of a programme with a short drying phase. In that cases, the regeneration prolongs the total duration of a programme by additional 5 minutes. Subsequently, the rinsing of the water softener that lasts 5 minutes may begin in the same cycle or at the beginning of the next programme. This activity

increases the total water consumption of a programme by additional 4 litres and the total energy consumption of a programme by additional 2 Wh. The rinsing of the softener ends with a complete drain.

Each performed softener rinse (possible more than one in the same cycle) may prolong the programme duration by another 5 minutes when it occurs at any point at the beginning or in the middle of a programme.





All the consumption values mentioned in this section are determined in accordance with the currently applicable standard in laboratory conditions with water hardness 2.5mmol/L according to the 2019/2022 regulation (water softener: level 3).

The pressure and the temperature of water as well as the variations of the mains supply can change the values.

How to set the water softener level

Make sure the appliance is in user mode.

1. Wait until the indicator  starts to flash, the indicator **ECO** continues to flash and the remaining indicators are off.

The intermittent flashing of the indicator  shows the current setting: e.g. 5 flashes + pause + 5 flashes = level 5.

2. Press the programme button repeatedly to change the setting. Each pressing of the programme button increases the level number. After reaching the level 10, the count starts again from the level 1.
3. Press the on/off button to confirm the setting.

THE RINSE AID EMPTY NOTIFICATION

The rinse aid helps to dry the dishes without streaks and stains. It is automatically released during the hot rinse phase.

When the rinse aid chamber is empty, the rinse aid indicator is turned on notifying to refill rinse aid. If the drying results are satisfactory while using multi-tablets only, it is possible to deactivate the notification for refilling rinse aid. However, for best drying performance, always use rinse aid.

If standard detergent or multi-tablets without rinse aid are used, activate the notification to keep the rinse aid refill indicator active.

How to deactivate the rinse aid empty notification



Make sure the appliance is in user mode.

1. Press the programme button immediately.

The indicator ¹⁶⁰_{min} starts to flash.

2. Wait until the indicator ¹⁶⁰_{min} continues to flash and the remaining programme indicators are off.

The indicator  shows the current setting:

-  is on = Rinse aid empty notification is on.
-  is off = Rinse aid empty notification is off.

3. Press the programme button to change the setting.
4. Press the on/off button to confirm the setting.

ACOUSTIC SIGNALS

Acoustic signals sound when a malfunction of the appliance occurs. It is not possible to deactivate these acoustic signals.

There is also an acoustic signal that sounds when the programme is completed. By default this acoustic signal is deactivated but it is possible to activate it.

How to activate the acoustic signal for the end of the programme



Make sure the appliance is in user mode.

1. Press the programme button twice.

The indicator ⁹⁰_{min} starts to flash.

2. Wait until the indicator ⁹⁰_{min} continues to flash and the remaining programme indicators are off.

The indicator  shows the current setting:

-  is off = The acoustic signal is off.
-  is on = The acoustic signal is on.

3. Press the programme button to change the setting.
4. Press the on/off button to confirm the setting.

AIRDRY

AirDry improves the drying results with less energy consumption.

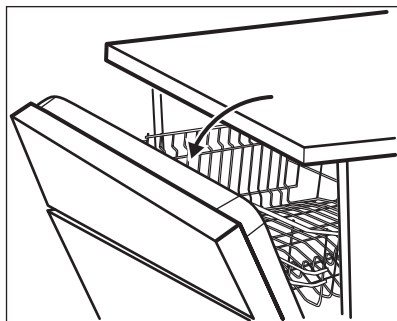

i During the drying phase, the door opens automatically and remains ajar.

! **CAUTION!** Do not try to close the appliance door within 2 minutes after automatic opening. This can cause damage to the appliance.

AirDry is automatically activated with all programmes excluding  (if applicable).

BEFORE FIRST USE

- 1. Make sure that the current level of the water softener agrees with the hardness of the water supply. If not, adjust the level of the water softener.**
2. Fill the salt container.
3. Fill the rinse aid dispenser.
4. Open the water tap.
5. Start a programme to remove any processing residuals that can still be inside the appliance. Do not use detergent and do not put dishes in the baskets.

After starting the programme, the appliance recharges the resin in the water softener for up to 5 minutes. The washing phase starts only after this procedure is complete. The procedure is repeated periodically.

THE SALT CONTAINER

! **CAUTION!** Use rough salt designed for dishwashers only. Fine salt increases the risk of corrosion.

The salt is used to recharge the resin in the water softener and to assure good washing results in daily use.

! **CAUTION!** If children have access to the appliance, it is advised to deactivate AirDry as opening the door may pose a danger.

How to deactivate the AirDry



Make sure the appliance is in user mode.

1. Press the programme button three times.

The indicator ³⁰min starts to flash.

2. Wait until the indicator ³⁰min continues to flash and the remaining programme indicators are off.

The indicator  shows the current setting:

-  is off = AirDry is off.
-  is on = AirDry is on.

3. Press the programme button to change the setting.
4. Press the on/off button to confirm the setting.

How to fill the salt container

1. Turn the cap of the salt container counterclockwise and remove it.
2. Put 1 litre of water in the salt container (only for the first time).
3. Fill the salt container with 1 kg of salt (until it is full).

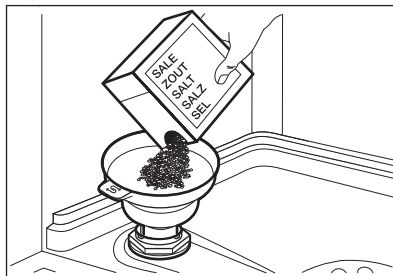

4. Carefully shake the funnel by its handle to get the last granules inside.
5. Remove the salt around the opening of the salt container.

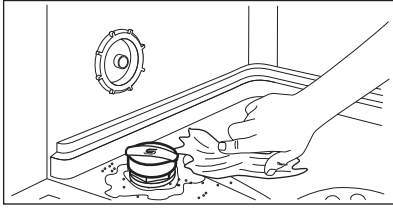

- Turn the cap of the salt container clockwise to close the salt container.



CAUTION! Water and salt can come out of the salt container when you fill it. After you fill the salt container, immediately start a programme to prevent corrosion.



CAUTION! Only use rinse aid designed specifically for dishwashers.

- Press the release button (D) to open the lid (C).
- Fill the dispenser (A) until the rinse aid reaches the marking "MAX".
- Remove the spilled rinse aid with an absorbent cloth to prevent excessive foam formation.
- Close the lid. Make sure that the release button locks into position.



You can turn the selector of the released quantity (B) between position 1 (lowest quantity) and position 4 or 6 (highest quantity).

HOW TO FILL THE RINSE AID DISPENSER

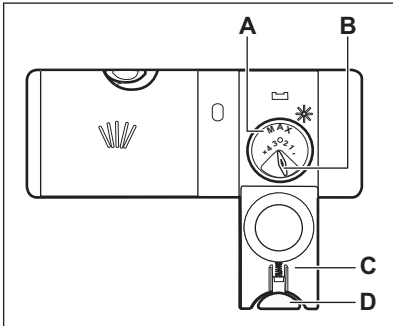

DAILY USE

- Open the water tap.
- Press the on/off button to activate the appliance.

Make sure that the appliance is in programme selection mode.

- If the salt indicator is on, fill the salt container.
 - If the rinse aid indicator is on, fill the rinse aid dispenser.
- Load the baskets.
 - Add the detergent.
 - Set and start the correct programme for the type of load and the degree of soil.

USING THE DETERGENT

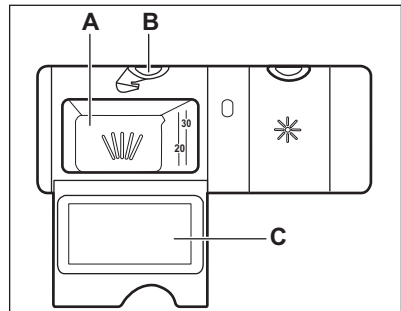

CAUTION! Only use detergent specifically designed for dishwashers.

- Press the release button (B) to open the lid (C).

- Put the detergent, in powder or tablets, in the compartment **(A)**.
- If the programme has a prewash phase, put a small quantity of detergent on the inner part of the appliance door.
- Close the lid. Make sure that the release button locks into position.



Do not try to close the appliance door within 2 minutes after AirDry automatically opens it, as this may cause damage to the appliance. If, afterwards, the door is closed for another 3 minutes, the running programme ends.

SETTING AND STARTING A PROGRAMME

Starting a programme

- Keep the appliance door ajar.
- Press the on/off button to activate the appliance. Make sure that the appliance is in programme selection mode.
- Press the programme button repeatedly until the indicator of the programme you want to select starts flashing.
- Close the appliance door to start the programme.

Starting a programme with delay start

- Set a programme.
- Press Delay Start to delay the start of the programme of 3 hours.
 - The indicator  comes on.
- Close the appliance door to start the countdown.

When the countdown is completed, the programme starts.

Opening the door while the appliance operates

Opening the door while a programme is running stops the appliance. It may affect the energy consumption and the programme duration. After closing the door, the appliance continues from the point of interruption.



If the door is opened for more than 30 seconds during the drying phase, the running programme ends. It does not happen if the door is opened by AirDry function.

Canceling the delay start

Press the on/off button for 3 seconds until the appliance is in programme selection mode.

When you cancel the delay start, you have to set the programme again.

Canceling the programme

Press and hold the programme button for 3 seconds until the appliance is in programme selection mode.

Make sure that there is detergent in the detergent dispenser before you start a new programme.

The Auto Off function

This function decreases energy consumption by deactivating automatically the appliance when it is not operating.

The function comes into operation:

- When the programme is complete.
- After 5 minutes if a programme was not started.

End of the programme

When the programme is complete, the programme indicator remains on until the Auto Off function switches the appliance off.

If the acoustic signal for the end of a programme is activated and the programme is complete, the appliance is automatically switched off after the signal sounds.

- Press any button to switch off the appliance or wait for the appliance to switch off automatically. If you close or open the door before automatic deactivation, the appliance is deactivated.
- Close the water tap.

HINTS AND TIPS

GENERAL

Follow the hints below to ensure optimal cleaning and drying results in daily use and to protect the environment.

- Washing dishes in the dishwasher as instructed in the user manual usually consumes less water and energy than washing dishes by hand.

- Load the dishwasher to its full capacity to save water and energy. For best cleaning results, arrange items in the baskets as instructed in the user manual and do not overload the baskets.
- Do not pre-rinse dishes by hand. It increases the water and energy consumption. When needed, select a programme with a prewash phase.

- Remove larger residues of food from the dishes and empty cups and glasses before putting them inside the appliance.
- Soak or slightly scour cookware with firmly cooked-on or baked-on food before washing it in the appliance.
- Make sure that items in the baskets do not touch or cover each other. Only then can the water completely reach and wash the dishes.
- You can use dishwasher detergent, rinse aid and salt separately or you can use the multi-tablets (e.g. "All in 1"). Follow the instructions on the packaging.
- Select a programme according to the type of load and the degree of soil. **ECO** offers the most efficient use of water and energy consumption.
- To prevent limescale buildup inside the appliance:
 - Refill the salt container whenever necessary.
 - Use the recommended dosage of the detergent and rinse aid.
 - Make sure that the current level of the water softener agrees with the hardness of the water supply.
 - Follow the instructions in the chapter "**Care and cleaning**".

USING SALT, RINSE AID AND DETERGENT

- Only use salt, rinse aid and detergent designed for dishwasher. Other products can cause damage to the appliance.
- In areas with hard and very hard water, we recommend to use basic dishwasher detergent (powder, gel, tablets containing no additional agents), rinse aid and salt separately for optimal cleaning and drying results.
- Detergent tablets do not fully dissolve with short programmes. To prevent detergent residues on the tableware, we recommend that you use tablets with long programmes.
- Always use the correct quantity of detergent. Insufficient dosage of detergent can result in poor cleaning results and hard-water filming or spotting on the items. Using too much detergent with soft or softened water results in detergent residues on the dishes. Adjust the amount of detergent based on the water hardness. Refer to the instructions on the detergent packaging.
- Always use the correct quantity of rinse aid. Insufficient dosage of rinse aid decreases the drying results. Using too much rinse aid results in bluish layers on the items.
- Make sure that the water softener level is correct. If the level is too high, the increased

quantity of salt in the water might result in rust on cutlery.

WHAT TO DO IF YOU WANT TO STOP USING MULTI-TABLETS

Before you start to use separately detergent, salt and rinse aid do the following procedure.

1. Set the highest level of the water softener.
2. Make sure that the salt and rinse aid containers are full.
3. Start the shortest programme with a rinsing phase. Do not add detergent and do not load the baskets.
4. When the programme is completed, adjust the water softener according to the water hardness in your area.
5. Adjust the released quantity of rinse aid.

LOADING THE BASKETS

- Always use the whole space of the baskets.
- Use the appliance to wash dishwasher-safe items only.
- Do not wash in the appliance items made of wood, horn, aluminium, pewter and copper as they could crack, warp, get discoloured or pitted.
- Do not wash in the appliance items that can absorb water (sponges, household cloths).
- Put hollow items (cups, glasses and pans) with the opening facing downwards.
- Make sure that glasses do not touch each other.
- Put light items in the upper basket. Make sure that the items do not move freely.
- Put cutlery and small items in the cutlery basket.
- Make sure that the spray arms can move freely before you start a programme.

BEFORE STARTING A PROGRAMME

Before you start the selected programme, make sure that:

- The filters are clean and correctly installed.
- The cap of the salt container is tight.
- The spray arms are not clogged.
- There is enough salt and rinse aid (unless you use multi-tablets).
- The arrangement of the items in the baskets is correct.
- The programme is suitable to the type of load and the degree of soil.
- The correct quantity of detergent is used.

UNLOADING THE BASKETS

1. Let the tableware cool down before you remove it from the appliance. Hot items can be easily damaged.

2. First remove items from the lower basket, then from the upper basket.



After the programme is completed, water can still remain on the inside surfaces of the appliance.

CARE AND CLEANING



WARNING! Before maintenance, deactivate the appliance and disconnect the mains plug from the main socket.



Dirty filters and clogged spray arms decrease the washing results. Make a check regularly and, if necessary, clean them.

CLEANING THE FILTERS

The filter system is made of 3 parts.

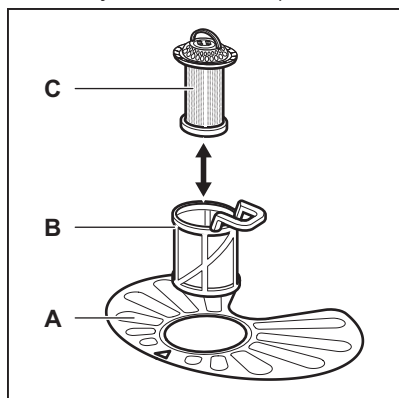

1. Turn the filter (B) counterclockwise and remove it.

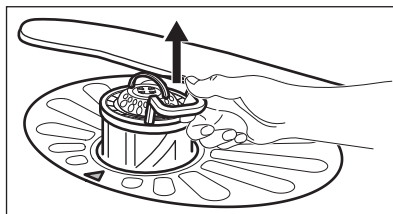
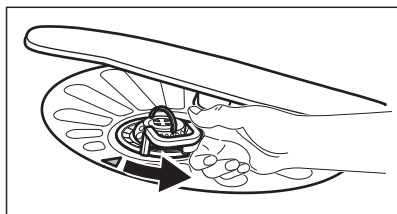

2. Remove the filter (C) out of filter (B).
3. Remove the flat filter (A).

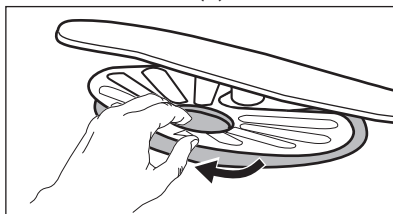

4. Wash the filters.

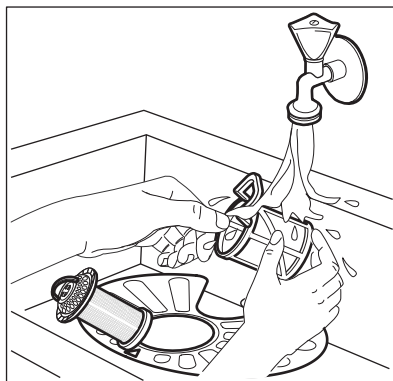

5. Make sure that there are no residues of food or soil in or around the edge of the sump.
6. Put back in place the flat filter (A). Make sure that it is correctly positioned under the 2 guides.

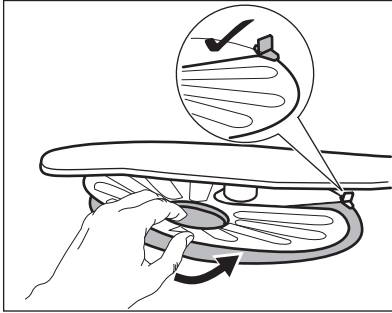

7. Reassemble the filters (B) and (C).
8. Put back the filter (B) in the flat filter (A). Turn it clockwise until it locks.

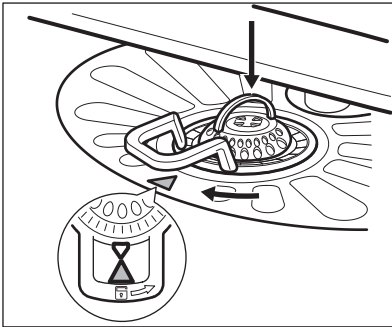

CAUTION! An incorrect position of the filters can cause bad washing results and damage to the appliance.

CLEANING THE LOWER SPRAY ARM

We recommend to clean the lower spray arm regularly to prevent soil from clogging the holes. Clogged holes can cause unsatisfactory washing results.

1. To remove the lower spray arm, pull it upwards.

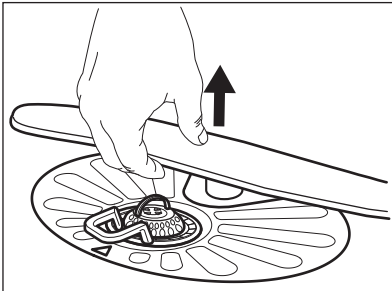

2. Wash the spray arm under running water. Use a thin pointed tool, e.g. a toothpick, to remove particles of soil from the holes.

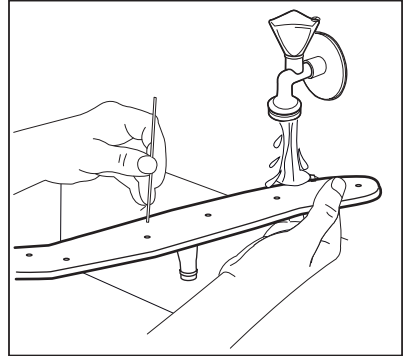

3. To install the spray arm back, press it downwards.

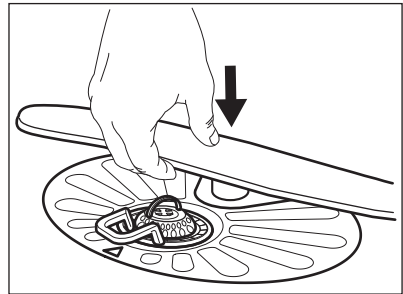

EXTERNAL CLEANING

- Clean the appliance with a moist soft cloth.
- Only use neutral detergents.
- Do not use abrasive products, abrasive cleaning pads or solvents.

INTERNAL CLEANING

- Carefully clean the appliance, including the rubber gasket of the door, with a soft damp cloth.
- To maintain the performance of your appliance, use a cleaning product designed specifically for dishwashers at least once a month. Carefully follow the instructions on the packaging of the product.
- Do not use abrasive products, abrasive cleaning pads, sharp tools, strong chemicals, scourer or solvents.
- Using short-duration programmes regularly can cause grease and limescale buildup inside the appliance. Run long-duration programmes at least twice a month to prevent the buildup.

REMOVAL OF FOREIGN OBJECTS

Check the filters and the sump after each use of the dishwasher. Foreign objects (e.g. pieces of glass, plastic, bones or toothpicks, etc) decrease the cleaning performance and can cause damage to the drain pump.

1. Disassemble the filters system as instructed in this chapter.

2. Remove any foreign objects by hand.



CAUTION! If unable to remove the objects, contact an Authorised Service Centre.

3. Reassemble the filters as instructed in this chapter.

TROUBLESHOOTING











WARNING! Improper repair of the appliance may pose a danger to the safety of the user. Any repairs must be performed by qualified personnel.

The majority of problems that can occur can be solved without the need to contact an Authorised Service Centre.

Refer to the below table for information on possible problems.

With some problems, the dedicated indicator flashes intermittently to indicate a malfunction and the alarm code.

Problem and alarm code	Possible cause and solution
You cannot activate the appliance.	<ul style="list-style-type: none">▪ Make sure that the mains plug is connected to the mains socket.▪ Make sure that there is no damaged fuse in the fuse box.
The programme does not start.	<ul style="list-style-type: none">▪ Make sure that the appliance door is closed.▪ If the delay start is set, cancel the setting or wait for the end of the countdown.▪ The appliance recharges the resin inside the water softener. The duration of the procedure is approximately 5 minutes.
The appliance does not fill with water. <ul style="list-style-type: none">▪ The indicator  flashes 1 time intermittently.▪ Acoustic signal sounds 1 time intermittently.	<ul style="list-style-type: none">▪ Make sure that the water tap is open.▪ Make sure that the pressure of the water supply is not too low. For this information, contact your local water authority.▪ Make sure that the water tap is not clogged.▪ Make sure that the filter in the inlet hose is not clogged.▪ Make sure that the inlet hose has no kinks or bends.
The appliance does not drain the water. <ul style="list-style-type: none">▪ The indicator  flashes 2 times intermittently.▪ Acoustic signal sounds 2 times intermittently.	<ul style="list-style-type: none">▪ Make sure that the sink spigot is not clogged.▪ Make sure that the interior filter system is not clogged.▪ Make sure that the drain hose has no kinks or bends.

Problem and alarm code	Possible cause and solution
<p>The anti-flood device is on.</p> <ul style="list-style-type: none"> ▪ The indicator  flashes 3 times intermittently. ▪ Acoustic signal sounds 3 times intermittently. 	<ul style="list-style-type: none"> ▪ Close the water tap. ▪ Make sure that the appliance is correctly installed. ▪ Make sure the baskets are loaded as instructed in the user manual.
<p>Malfunction of the water level detection sensor.</p> <ul style="list-style-type: none"> ▪ The indicator  flashes 4 times intermittently. ▪ Acoustic signal sounds 4 times intermittently. 	<ul style="list-style-type: none"> ▪ Make sure that the filters are clean. ▪ Switch the appliance off and on.
<p>Malfunction of the wash pump or the drain pump.</p> <ul style="list-style-type: none"> ▪ The indicator  flashes 5 times intermittently. ▪ Acoustic signal sounds 5 times intermittently. 	<ul style="list-style-type: none"> ▪ Switch the appliance off and on.
<p>The temperature of the water inside the appliance is too high or malfunction of the temperature sensor occurred.</p> <ul style="list-style-type: none"> ▪ The indicator  flashes 6 times intermittently. ▪ Acoustic signal sounds 6 times intermittently. 	<ul style="list-style-type: none"> ▪ Make sure that the temperature of the inlet water does not exceed 60°C. ▪ Switch the appliance off and on.
<p>Technical malfunction of the appliance.</p> <ul style="list-style-type: none"> ▪ The indicator  flashes 12 times intermittently. ▪ Acoustic signal sounds 12 times intermittently. 	<ul style="list-style-type: none"> ▪ Switch the appliance off and on.
<p>The level of water inside the appliance is too high.</p> <ul style="list-style-type: none"> ▪ The indicator  flashes 15 times intermittently. ▪ Acoustic signal sounds 15 times intermittently. 	<ul style="list-style-type: none"> ▪ Switch the appliance off and on. ▪ Make sure that the filters are clean. ▪ Make sure that the outlet hose is installed at the right height above the floor. Refer to the installation instructions.
<p>The appliance stops and starts more times during operation.</p>	<ul style="list-style-type: none"> ▪ It is normal. It provides optimal cleaning results and energy savings.
<p>The programme lasts too long.</p>	<ul style="list-style-type: none"> ▪ If the delayed start option is set, cancel the delay setting or wait for the end of the countdown.
<p>Small leak from the appliance door.</p>	<ul style="list-style-type: none"> ▪ The appliance is not levelled. Loosen or tighten the adjustable feet (if applicable). ▪ The appliance door is not centred on the tub. Adjust the rear foot (if applicable).

Problem and alarm code	Possible cause and solution
The appliance door is difficult to close.	<ul style="list-style-type: none"> ▪ The appliance is not levelled. Loosen or tighten the adjustable feet (if applicable). ▪ Parts of the tableware are protruding from the baskets.
Rattling/knocking sounds from inside the appliance.	<ul style="list-style-type: none"> ▪ The tableware is not properly arranged in the baskets. Refer to basket loading leaflet. ▪ Make sure that the spray arms can rotate freely.
The appliance trips the circuit-breaker.	<ul style="list-style-type: none"> ▪ The amperage is insufficient to supply simultaneously all the appliances in use. Check the socket amperage and the capacity of the meter or turn off one of the appliances in use. ▪ Internal electrical fault of the appliance. Contact an Authorised Service Centre.



Refer to "**Before first use**", "**Daily use**", or "**Hints and tips**" for other possible causes.



WARNING! We do not recommend using the appliance until the problem has been completely fixed. Unplug the appliance and do not plug it in again until you are certain that it operates correctly.

Once you have checked the appliance, deactivate and activate the appliance. If the problem occurs again, contact an Authorised Service Centre.

For alarm codes not described in the table, contact an Authorised Service Centre.

THE WASHING AND DRYING RESULTS ARE NOT SATISFACTORY

Problem	Possible cause and solution
Poor washing results.	<ul style="list-style-type: none"> ▪ Refer to "Daily use", "Hints and tips" and basket loading leaflet. ▪ Use more intensive washing programmes. ▪ Clean spray arm jets and filter. Refer to "Care and Cleaning".
Poor drying results.	<ul style="list-style-type: none"> ▪ Tableware has been left for too long inside a closed appliance. ▪ There is no rinse aid or the dosage of rinse aid is not enough. Set the rinse aid dispenser to a higher level. ▪ Plastic items may need to be towel dried. ▪ For the best drying performance activate AirDry. ▪ We recommend to always use rinse aid, even in combination with multi-tablets.
There are whitish streaks or bluish layers on glasses and dishes.	<ul style="list-style-type: none"> ▪ The release quantity of rinse aid is too much. Adjust the rinse aid level to a lower level. ▪ The quantity of detergent is too much.

Problem	Possible cause and solution
There are stains and dry water drops on glasses and dishes.	<ul style="list-style-type: none"> ▪ The released quantity of rinse aid is not sufficient. Adjust the rinse aid level to a higher level. ▪ The quality of the rinse aid can be the cause.
The dishes are wet.	<ul style="list-style-type: none"> ▪ For the best drying performance activate AirDry. ▪ The programme does not have a drying phase or has a drying phase with low temperature. ▪ The rinse aid dispenser is empty. ▪ The quality of the rinse aid can be the cause. ▪ The quality of the multi-tablets can be the cause. Try a different brand or activate the rinse aid dispenser and use rinse aid and multi-tablets together.
The interior of the appliance is wet.	<ul style="list-style-type: none"> ▪ This is not a defect of the appliance, it is caused by the humidity in the air that condenses on the walls.
Unusual foam during washing.	<ul style="list-style-type: none"> ▪ Use the detergent for dishwashers only. ▪ There is a leak in the rinse aid dispenser. Contact an Authorised Service Centre.
Traces of rust on cutlery.	<ul style="list-style-type: none"> ▪ There is too much salt in the water used for washing. Refer to "The water softener". ▪ Silver and stainless steel cutlery were placed together. Avoid to put silver and stainless steel items close together.
There are residues of detergent in the dispenser at the end of the programme.	<ul style="list-style-type: none"> ▪ The detergent tablet got stuck in the dispenser and therefore was not completely washed away by water. ▪ Water cannot wash away the detergent from the dispenser. Make sure that the spray arm is not blocked or clogged. ▪ Make sure that items in the baskets do not impede the lid of the detergent dispenser from opening.
Odours inside the appliance.	<ul style="list-style-type: none"> ▪ Refer to "Internal cleaning".
Limescale deposits on the tableware, on the tub and on the inside of the door.	<ul style="list-style-type: none"> ▪ The level of salt is low, check the refill indicator. ▪ The cap of the salt container is loose. ▪ Your tap water is hard. Refer to "The water softener". ▪ Even using multi-functional tabs use salt and set regeneration of the water softener. Refer to "The water softener". ▪ If lime scale deposits still remain, clean the appliance with appliance cleaners which are particularly suitable for this purpose. ▪ Try different detergent. ▪ Contact the detergent manufacturer.
Dull, discoloured or chipped tableware.	<ul style="list-style-type: none"> ▪ Make sure that only dishwasher-safe items are washed in the appliance. ▪ Load and unload the basket carefully. Refer to basket loading leaflet. ▪ Place delicate items in the upper basket.



Refer to "**Before first use**", "**Daily use**" or "**Hints and tips**" for other possible causes.

TECHNICAL INFORMATION

Dimensions	Width / height / depth (mm)	596 / 818 - 898 / 550
Electrical connection ¹⁾	Voltage (V)	220 - 240
	Frequency (Hz)	50
Water supply pressure	Min. / max. bar (MPa)	0.5 (0.05) / 8 (0.8)
Water supply	Cold water or hot water ²⁾	max 60 °C
Capacity	Place settings	13
Power consumption	Left-on mode (W)	5.0
	Off-mode (W)	0.50

1) Refer to the rating plate for other values.

2) If the hot water comes from alternative source of energy (e.g. solar panels), use the hot water supply to decrease energy consumption.

LINK TO THE EU EPREL DATABASE

The QR code on the energy label supplied with the appliance provides a web link to the registration of this appliance in the EU EPREL database. Keep the energy label for reference together with the user manual and all other documents provided with this appliance.

It is possible to find information related to the performance of the product in the EU EPREL

database using the link <https://eprel.ec.europa.eu> and the model name and product number that you can find on the rating plate of the appliance. Refer to the chapter "Product description".

For more detailed information about the energy label, visit www.theenergylabel.eu.

ENVIRONMENTAL CONCERNS

Recycle materials with the symbol . Put the packaging in relevant containers to recycle it. Help protect the environment and human health by recycling waste of electrical and electronic appliances. Do not dispose of appliances marked

with the symbol  with the household waste. Return the product to your local recycling facility or contact your municipal office.

WWW.ZANUSSI.COM/SHOP



CE

156940950-A-082020