

SHARP

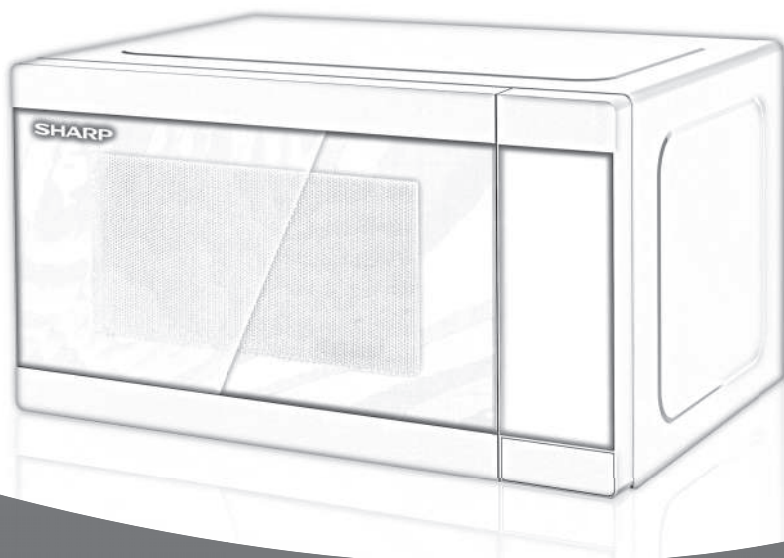

User manual

YC-MC422A

Microwave oven

EN

BG

CS

DA

DE

ES

ET

EL

FR

FI

HR

HU

IT

LT

LV

NO

NL

PL

PT

RO

SK

SL

SR

SV

UA

*Product images are for illustration purpose only. Actual product may vary.



Attention:

Your product is marked with this symbol. It means that used electrical and electronic products should not be mixed with general household waste. There is a separate collection system for these products.



www.sharpconsumer.com/contact/



www.sharpconsumer.com/support/



www.sharpconsumer.com/documents-of-conformity/

A. Information on Disposal for Users (private households)

1. In the European Union

Attention: If you want to dispose of this equipment, please do not use the ordinary dustbin!

Used electrical and electronic equipment must be treated separately and in accordance with legislation that requires proper treatment, recovery and recycling of used electrical and electronic equipment.

Following the implementation by member states, private households within the EU states may return their used electrical and electronic equipment to designated collection facilities free of charge*.

In some countries* your local retailer may also take back your old product free of charge if you purchase a similar new one.

*) Please contact your local authority for further details.

If your used electrical or electronic equipment has batteries or accumulators, please dispose of these separately beforehand according to local requirements. By disposing of this product correctly you will help ensure that the waste undergoes the necessary treatment, recovery and recycling and thus prevent potential negative effects on the environment and human health which could otherwise arise due to inappropriate waste handling.

2. In other Countries outside the EU

If you wish to discard this product, please contact your local authorities and ask for the correct method of disposal.

For Switzerland: Used electrical or electronic equipment can be returned free of charge to the dealer, even if you don't purchase a new product.

Further collection facilities are listed on the homepage of www.swico.ch or www.sens.ch.

B. Information on Disposal for Business Users

1. In the European Union

If the product is used for business purposes and you want to discard it:

Please contact your SHARP dealer who will inform you about the take-back of the product. You might be charged for the costs arising from take-back and recycling. Small products (and small amounts) might be taken back by your local collection facilities.

For Spain: Please contact the established collection system or your local authority for take-back of your used products.

2. In other Countries outside the EU

If you wish to discard of this product, please contact your local authorities and ask for the correct method of disposal.

CONTENTS

Important safety instructions	3
Installation	11
Specifications	12
Oven and accessories	13
Control panel	14
Before operation	15
Setting the clock	15
Microwave power level	16
Manual operation	17
Microwave cooking	18
Grill cooking	19
Microwave and grill combination cooking	19
Preheat/convection cooking	20
Microwave and convection combination cooking	20
Other convenient functions	21
Defrosting by time	22
Defrosting by weight	22
Cooking using the microwave sensor	23
Cooking using the auto grill menu	23
Cooking using the auto convection menu	24
Microwave sensor cooking chart	25
Auto grill menu cooking chart	26
Auto convection menu cooking chart	27
Suitable ovenware	28
Cleaning and care	29
Microwave cooking advice	30
Defrosting advice	32
Reheating advice	33
Troubleshooting	34
Before calling for assistance	36

PRECAUTIONS TO AVOID POSSIBLE EXPOSURE TO MICROWAVE ENERGY

1. Do not attempt to operate this oven with the door open as this can result in harmful exposure to microwave energy. It is important not to defeat or tamper with the safety interlocks.
2. Do not insert anything between the oven front face and the door or allow debris or cleaner residue to accumulate on sealing surfaces.
3. Do not operate the oven if it is damaged. It is very important that the oven door closes properly and that there is no damage to the door, hinges, latches or door seals and sealing surfaces.
4. Do not attempt to repair or adjust the oven.

Important safety instructions

READ CAREFULLY AND KEEP FOR FUTURE REFERENCE

To avoid the danger of fire:

The microwave oven should not be left unattended during operation. Power levels that are too high, or cooking times that are too long, may overheat foods resulting in a fire.

This oven is designed to be used on a countertop only. It is not designed to be built into a kitchen unit. Do not place the oven in a cabinet. The electrical outlet must be readily accessible so that the unit can be unplugged easily in an emergency.

The AC power supply must be 230 V, 50 Hz for YC-MC422AE-SB, or 230-240 V, 50 Hz for YC-MC422AU-SB, with a minimum 20 A distribution line fuse, or a minimum 20 A distribution circuit breaker. A separate circuit serving only this appliance should be provided.

Do not place the oven in areas where heat is generated. For example, close to a conventional oven. Do not install the oven in an area of high humidity or where moisture may collect. Do not store or use the oven outdoors.

If smoke is observed, switch off or unplug the oven and keep the door closed in order to stifle any flames.

Metallic containers for food and beverages are not allowed during microwave modes.

Use only microwave-safe containers and utensils when in microwave modes. Utensils should be checked to ensure that they are suitable for use in microwave ovens.

When heating food in plastic or paper containers, keep an eye on the oven due to the possibility of ignition.

Clean the waveguide cover and the oven cavity. These must be dry and free from grease. Built up grease may overheat and begin to smoke or catch fire.

Do not place flammable materials near the oven or ventilation openings. Do not block the ventilation openings.

Remove all metallic seals, wire twists, etc., from food and food packages. Arcing on metallic surfaces may cause a fire.

Do not use the microwave oven to heat oil for deep frying. The temperature cannot be controlled and the oil may catch fire.

To make popcorn, use only special microwave popcorn makers.

Do not store food or any other items inside the oven.

Check the settings after you start the oven to ensure the oven is operating as desired.

Do not leave the oven unattended while it is operating.

To avoid overheating and fire, special care must be taken when cooking or reheating foods with a high sugar or fat content, for example, Sausage rolls, Pies or Christmas pudding. See the corresponding hints in the user manual.

To avoid the possibility of injury: WARNING:

Do not operate the oven if it is damaged or malfunctioning.

Check the following before use:

- a) Make sure the door closes properly and ensure it is not misaligned or warped.
- b) Check to make sure the hinges and safety door latches are not broken or loose.
- c) Ensure that the door seals and sealing surfaces have not been damaged.
- d) Make sure inside the oven cavity or on the door are no dents.
- e) Ensure that the power supply cord and plug are not damaged.

If the door or door seals are damaged, the oven must not be operated until it has been repaired by a competent person.

Never adjust, repair or modify the oven yourself. It is hazardous for anyone other than a competent person to carry out any service or repair operation which involves the removal of a cover which gives protection against exposure to microwave energy.

Do not operate the oven with the door open or alter the door safety latches in any way. Do not operate the oven if there is an object between the door seals and sealing surfaces.

Do not allow grease or dirt to build up on the door seals and adjacent parts. Clean the oven at regular intervals and remove any food deposits.

Follow the instructions for "Care and Cleaning" in the full version of the User Manual. Failure to maintain the oven in a clean condition could lead to a deterioration of the surface that could adversely affect the life of the appliance and possibly result in a hazardous situation.

Do not use harsh abrasive cleaners or sharp metal scrapers to clean the oven door glass, since they can scratch the surface, which may result in shattering of the glass.

The appliance shall not be cleaned with a steam cleaner.

Individuals with PACEMAKERS should check with their doctor or the manufacturer of the pacemaker for precautions regarding microwave ovens.

To avoid the possibility of electric shock:

- Under no circumstances should you remove the outer cabinet.
- Never spill or insert any objects into the door lock openings or ventilation openings. In the event of a spill, turn off and unplug the oven immediately, and call an authorised SHARP service agent.
- Do not immerse the power supply cord or plug in water or

any other liquid.

- Do not let the power supply cord hang over the edge of a table or work surface.
- Keep the power supply cord away from heated surfaces, including the rear of the oven.
- Do not attempt to replace the oven lamp yourself or allow anyone who is not an electrician authorised by SHARP to do so. If the oven lamp fails, please consult your dealer or an authorised SHARP service agent.
- If the power supply cord is damaged, it must be replaced by an authorised SHARP service agent.

To avoid the possibility of explosion and sudden boiling:

WARNING: Liquids and other foods must not be heated in sealed containers since they are liable to explode. Microwave heating of beverages can result in delayed eruptive boiling; therefore, care must be taken when handling the container.

Never use sealed containers. Remove seals and lids before use. Sealed containers can explode due to a build-up of pressure even after the oven has been turned off. Take care when microwaving liquids. Use a wide mouthed container to allow bubbles to escape.

Never heat liquids in narrow necked containers such as baby bottles, as this may result in the contents erupting from the container when heated and cause burns.

To prevent sudden eruption of boiling liquid and possible scalding:

1. Do not use excessive amount of time.
2. Stir liquid prior to heating/reheating.
3. It is advisable to insert a glass rod or similar utensil (not metal) into the liquid whilst reheating.
4. Let liquid stand for at least 20 seconds in the oven at the end of cooking time to prevent delayed eruptive boiling.

Do not cook eggs in their shells, and whole hard-boiled eggs should not be heated in microwave ovens since they may explode even after microwave cooking has ended. To cook or reheat eggs which have not been scrambled or mixed, pierce the yolks and the whites. Shell and slice hard boiled eggs before reheating them in the microwave oven.

Pierce the skin of such foods as potatoes, sausages and fruit before cooking, or they may explode.

To avoid the possibility of burns:

WARNING: The appliance and its accessible parts become hot during use. Care should be taken to avoid touching heating elements. Children less than 8 years of age shall be kept away unless continuously supervised.

The contents of feeding bottles and baby food jars must be stirred or shaken and the temperature checked before consumption, in order to avoid burns. Use pot holders or oven gloves when removing food from the oven to prevent burns.

- During use the appliance becomes hot. Care should be taken to avoid touching heating elements inside the oven.
- Always open containers, popcorn makers, oven cooking bags, etc., away from the face and hands to avoid steam burns and eruption of boiling. To avoid burns, always test food temperature and stir before serving and pay special attention to the temperature of food and drink given to babies, children or the elderly. Accessible parts may become hot during use. Young children should be kept away.
- Temperature of the container is not a true indication of the temperature of the food or drink; always check the food temperature.
- Always stand back from the oven door when opening it to avoid burns from escaping steam and heat.
- Slice stuffed baked foods after heating to release steam and

avoid burns.

- Keep children away from the door to prevent them burning themselves.

To avoid misuse by children:

WARNING: Only allow children aged from 8 years and above to use the oven without supervision when adequate instructions have been given so that the child is able to use the oven in a safe way and understands the hazards of improper use.

When the appliance is operated in ANY mode which generates direct heat (mode applicable to model), children should only use the oven under adult supervision due to the temperature generated.

This appliance is not intended for use by persons (including children) with reduced physical, sensory or mental capabilities, or lack of experience and knowledge, unless they have been given supervision or instruction concerning use of the appliance by a person responsible for their safety.

Children should be supervised to ensure that they do not play with the appliance. Cleaning by children should be monitored.

Models with Electronic touch panel are enabled with a child lock mode.

Do not lean or swing on the oven door. Do not play with the oven or use it as a toy.

Children should be taught all important safety instructions: use of pot holders, careful removal of food coverings - paying special attention to packaging (e.g., self-heating materials) designed to make food crisp, as they may be extra hot.

Other warnings:

Never modify the oven in any way.

Do not move the oven while it is in operation.

This appliance is intended to be used in household. This oven is only for home food preparation and may only be used for cooking food and beverages. Drying of food or clothing and heating of warming pads, slippers, sponges, damp cloth and similar may lead to risk of injury, ignition or fire. It is not suitable for commercial or laboratory use.

To promote trouble-free use of your oven and avoid damage.

Never operate the oven when it is empty. When using a browning dish or self-heating material, always place a heat-resistant insulator such as a porcelain plate under it to prevent damage to the oven base due to heat stress. The preheating time specified in the dish's instructions must not be exceeded.

Do not use metal utensils, which reflect microwaves and may cause electrical arcing. Do not put cans in the oven.

To prevent the turntable or base of the oven breaking:

- a) Before cleaning with water, leave to cool.
- b) Do not put hot foods or hot utensils on a cold turntable/oven base.
- c) Do not place cold foods or cold utensils on a hot turntable/oven base.

Do not place anything on the outer cabinet during operation.

NOTE:

Do not use plastic containers for microwaving if the oven is still hot from using grill, convection or a combination mode (oven model dependant) because they may melt.

Plastic containers must not be used during above modes unless the container manufacturer says they are suitable.

If you are unsure how to connect your oven, please consult an authorised, qualified electrician.

Neither the manufacturer nor the dealer can accept any liability

for damage to the oven or personal injury resulting from failure to observe the correct electrical connection procedure.

Water vapour or drops may occasionally form on the oven walls or around the door seals and sealing surfaces. This is a normal occurrence and is not an indication of microwave leakage or a malfunction.

This appliance is intended for use in household and similar applications such as; Kitchen areas reserved for staff in stores, offices and other professional environments / Farms / Use by clients of hotels, motels and other residential type environments / Bed and breakfast type environments.



This symbol means that the surfaces are liable to get hot during use.

Installation

1. Remove all packing materials from the inside of the oven cavity and remove any protective film found on the microwave oven cabinet surface.
2. Check the oven carefully for any signs of damage.
3. Place the oven on a secure, level surface, strong enough to take the oven weight, plus the heaviest item likely to be cooked in the oven. Do not place the oven in a cabinet.
4. Select a level surface that provide enough open space for the intake and/or outlet vents. The rear surface of appliance can be placed against a wall.
 - The appliance must not be installed behind a decorative door in order to avoid overheating.
 - The minimum installation height is 85 cm.
 - A minimum space of 20 cm is required between the sides of the microwave oven and any adjacent walls or objects.
 - Leave a minimum space of 30 cm above the oven.
 - Do not remove the feet from the bottom of the oven.
 - Blocking the intake and/or outlet openings can damage the oven.
 - Place the oven as far away from radios and TV as possible. Operation of microwave oven may cause interference to your radio or TV reception.

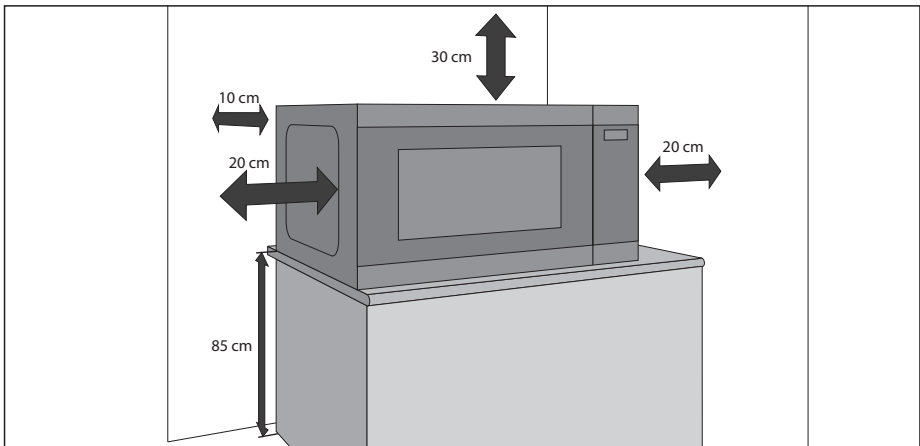

5. Securely connect the plug of the oven to a standard earthed (grounded) household electrical outlet.

WARNING:

Do not place the oven where heat, moisture or high humidity are generated, (for example, near or above a conventional oven) or near combustible materials (for example, curtains).

Do not block or obstruct air vent openings.

Do not place objects on top of the oven.

Do not touch the exterior of the microwave oven during or shortly after operation as it will be hot.

Specifications

Model name		YC-MC422AE-SB	YC-MC422AU-SB
AC Mains Plug		EU Two Pin	UK Three Pin
AC Line Voltage		230 V/50 Hz	230 V~240V/50 Hz
Distribution line fuse/circuit breaker		20 A	20 A
AC Power required		2700 W	2800 W
Output power:	Microwave	1000 W	1000 W
	Grill	1300 W	1400 W
	Convection	2700 W	2800 W
Microwave Frequency		2450 MHz*	2450 MHz*
Outside Dimensions (W) x (H) x (D) mm		553 x 326 x 505	553 x 326 x 505
Cavity Dimensions (W) x (H) x (D)** mm		395 x 272 x 387	395 x 272 x 387
Oven Capacity		42 litres**	42 litres**
High Rack (Diameter x Height in mm)		243 x 90	243 x 90
Low Rack (Diameter x Height in mm)		266 x 30	266 x 30
Baking Tray (Diameter in mm)		283	283
Turntable (Diameter in mm)		345	345
Weight (kg)		20	20
Oven Bulb (LED type)		1,5 W	1,5 W

* - **This Product fulfils the requirement of the European standard EN55011.**

In conformity with this standard, this product is classified as group 2 class B equipment.

Group 2 means that the equipment intentionally generates radio-frequency energy in the form of electromagnetic radiation for the heat treatment of food.

Class B equipment means that the equipment is suitable to be used in domestic establishments.

** - **Internal capacity is calculated by measuring maximum width, depth and height. Actual capacity for holding food is less.**

AS PART OF A POLICY OF CONTINUOUS IMPROVEMENT, WE RESERVE THE RIGHT TO ALTER DESIGN AND SPECIFICATIONS WITHOUT NOTICE.

Oven and accessories

Oven

1. Door safety lock system
2. Oven window
3. Glass turntable
4. Turntable support
5. Coupling
6. Waveguide cover (Do Not remove)
7. Power and Time controls
8. Door opening button
9. Grill heating element
10. Ventilation openings
11. Outer cabinet
12. Power supply cord

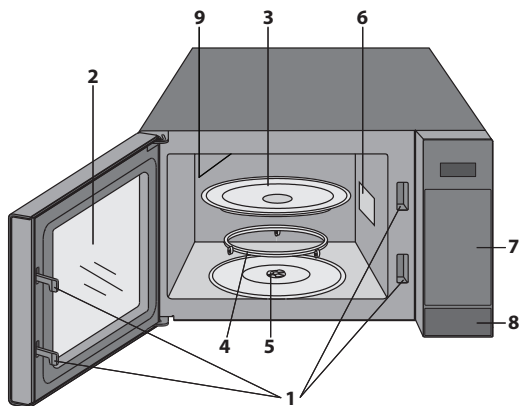

Supplied accessories:

1. Glass turntable
 2. Turntable support
 3. Coupling
 4. Low rack
 5. High rack
 6. Baking tray
- The Grill Racks and Baking Tray are designed for use when using the grill and convection modes only. DO NOT use any metal accessories when using the microwave function.

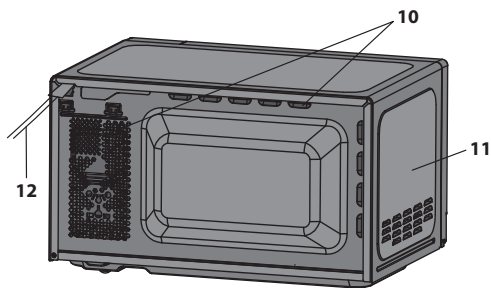

NOTE: When you order accessories, please mention two items: part name and model name.

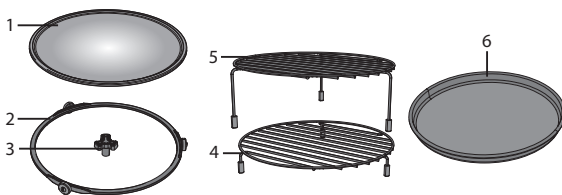

NOTES:

- The waveguide cover is fragile. Care should be taken when cleaning inside the oven to ensure that it is not damaged.
- After cooking fatty foods without a cover, always clean the cavity and especially the grill heating element thoroughly, these must be dry and free from grease. Built-up grease may overheat and begin to smoke or catch fire.
- Always operate the oven with the turntable and turntable support fitted correctly. This promotes thorough, even cooking. A badly fitted turntable may rattle, may not rotate properly and could cause damage to the oven.
- All food and containers of food are always placed on the turntable for cooking.
- The turntable rotates clockwise or anticlockwise. The rotary direction may change each time you start the oven. This does not affect cooking performance.

⚠ WARNING: The door, outer cabinet, oven cavity, accessories and dishes will become very hot during operation. To prevent burns, always use thick oven gloves.

Control panel

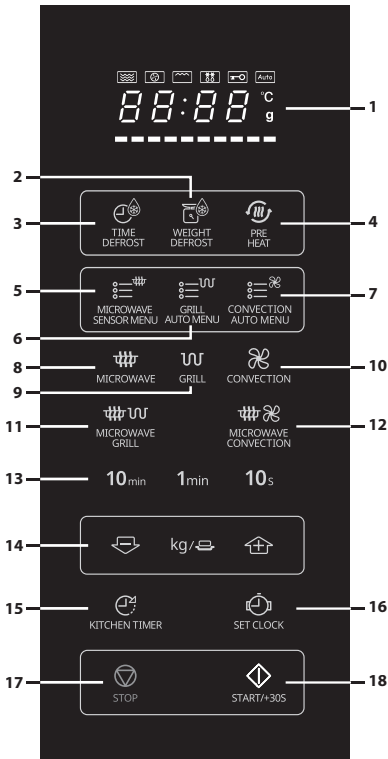

- DIGITAL DISPLAY** – Cooking time, power, indicators and clock time are displayed.

[MICROWAVE] indicator

[CONVECTION] indicator

[GRILL] indicator

[DEFROST] indicator

[CHILD LOCK] indicator

[AUTO MENU] indicator

[TEMPERATURE] indicator

[WEIGHT] indicator

[TEMPERATURE PROGRESS] indicator

The segments gradually light up to show the temperature reached in CONVECTION mode. Each segment represents 10°C of the set temperature level (For example, the first one indicates 140°C and the last one 230°C). When you set the temperature the corresponding segment illuminates while the respective segments to the left of it illuminate respectively one by one during the preheating process.



- WEIGHT DEFROST** – Press once to defrost based on weight.
- TIME DEFROST** – Press to select defrosting by time.
- PREHEAT** – Press to preheat the oven in convection mode.
- MICROWAVE SENSOR MENU** – Press to select sensor cooking menu.
- GRILL AUTO MENU** – Press to select grill auto cooking menus.
- CONVECTION AUTO MENU** – Press to select convection auto cooking menus.
- MICROWAVE POWER** – Press to select microwave power level.
- GRILL** – Press to set grill cooking mode.
- CONVECTION** – Press to set convection cooking mode.
- MICROWAVE+GRILL** – Press to set microwave and grill combination cooking modes.
- MICROWAVE+CONVECTION** – Press to set microwave and convection combination cooking modes.
- TIME** – Set the clock and timer.
- WEIGHT/PORTION** – Use these buttons to select weight or portions.
- KITCHEN TIMER** – Press to use as a minute timer, or to programme standing time.
- SET CLOCK** – Use to set clock time.
- STOP** – Press once to pause cooking or twice to cancel operation.
- START/+30s** – Start button. Press once to cook for 30 seconds on full power.

Before operation

- Plug in the oven. The oven display will display: [":0:00"], an audible signal will sound once.
- This model has a clock function and the oven which consumes less than 1.0 W in standby mode. [To set the clock, see below.]

Setting the clock

Your oven has a 12 hour and a 24 hour clock mode.

1. Press the [SET CLOCK] button  once and the display will show 24H. Within 3 seconds, press the button once again to choose the clock mode 12H or 24H. Press the [START/+30S] button to confirm the clock mode.
2. Press the time buttons and enter the current time. Enter the hours by pressing the [10 min] button and enter the minutes by pressing the [1 min] and [10 s] buttons.
3. Press the [SET CLOCK] button  to finish clock setting.

NOTES:

- If the clock is set, when cooking is complete, the display will show the correct time of day. If the clock has not been set, the display will only show "0:00" when cooking is complete.
- To check the time of day during a cooking process, press the [SET CLOCK] button and the LED will display the time of day for 2-3 seconds. This does not affect the cooking process.
- While in the clock setting mode, if the [STOP] button is pressed or if there is no operation within 1 minute, the oven will go back to the former setting.
- If the electrical power supply to your microwave oven is interrupted, the display will intermittently show "0:00" after the power is reinstated. If this occurs during cooking, the programme will be erased. The time of day will also be erased.

Microwave power level

Power Level	Press the [MICROWAVE POWER] button 	Display (Percentage)
HIGH	x1	P100
	x2	P90
MEDIUM HIGH	x3	P80
	x4	P70
MEDIUM	x5	P60
	x6	P50
MEDIUM LOW (DEFROST)	x7	P40
	x8	P30
LOW	x9	P20
	x10	P10
	x11	P0

- Your oven has 11 power levels, as shown.
- To change the power level for cooking, press the [MICROWAVE POWER] button until the display indicates the desired level. Set up the desired cooking time by pressing time buttons. Press the [START] button to start the oven.
- To check the power level during cooking, press the [MICROWAVE POWER] button.
As long as your finger is pressing the [MICROWAVE POWER] button the power level will be displayed. The oven continues to count down although the display will show the power level.
- If "P0" is selected, the oven will work with fan for no power. You can use this level to remove any odours.

Generally the following recommendations apply:

P100/P90 - (HIGH) used for fast cooking or reheating e.g. for casseroles, hot beverages, vegetables etc.

P80/P70 - (MEDIUM HIGH) used for longer cooking of dense foods such as roast joints, meat loaf and plated meals, also for sensitive dishes such as sponge cakes. At this reduced setting, the food will cook evenly without over cooking at the sides.

P60/P50 - (MEDIUM) for dense foods which require a long cooking time when cooked conventionally, e.g. beef casserole, it is advisable to use this power setting to ensure the meat will be tender.

P40/P30 - (MEDIUM LOW) to defrost, select this power setting, to ensure that the dish defrosts evenly. This setting is also ideal for simmering rice, pasta, dumplings and cooking egg custard.

P20/P10 - (LOW) For gentle defrosting, e.g. cream, gateaux, or pastry.

Manual operation

Opening the door:

To open the oven door, press door opening button.

Starting the oven:

Prepare and place food in a suitable container onto the turntable or place directly onto the turntable.

Close the door and press the [START/+30s] button after selecting the desired cooking mode and selecting the time. You may extend the desired cooking time during manual cooking by pressing the [TIME] buttons or the [START/+30s] button.

Once the cooking programme has been set and the [START/+30s] button is not pressed in 1 minute, the setting will be cancelled.

The [START/+30s] button must be pressed to continue cooking if the door is opened during cooking. The audible signal will sound once when the button is pressed in the correct manner.

Use the [STOP] button to:

1. Erase a mistake during programming.
2. Stop the oven temporarily during cooking.
3. Cancel a programme during cooking, press the [STOP] button twice.
4. To set and to cancel the child lock.



NOTE

- If the Microwave is not used for a period of 5 minutes (and the door is closed) the safety lock will automatically activate. All of the buttons will no longer operate in the safety lock mode. To turn the safety lock off simply open the door to the Microwave and the button will become active again.

Microwave cooking



Your oven can be programmed for up 99 minutes 50 seconds (99.50).

MANUAL COOKING/MANUAL DEFROSTING

- Enter the cooking time and use microwave power levels P100 to P10 to cook or defrost.
- Stir or turn the food, where possible, 2 - 3 times during cooking.
- After cooking, cover the food and leave to stand, where recommended.
- After defrosting, cover the food in foil and leave to stand until thoroughly defrosted.

Example:

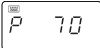
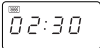
To cook 2 minutes and 30 seconds on P70 microwave power.

<p>1. Input the power level by pressing the [MICROWAVE POWER] button 4 times for 70 P.</p> <p> x4</p>	<p>2. Enter the cooking time by pressing the [1 min] button twice and then the [10 s] button 3 times.</p>	<p>3. Press the [START/+30s] button to start the timer. (The display will count down through the set cooking/defrosting time.)</p>
<p></p>	<p></p>	<p></p>

NOTE:

- When the oven starts, the oven lamp will light and the turntable will rotate clockwise or anticlockwise.
- If the door is opened during cooking/defrosting to stir or turn over food, the cooking time on the display stops automatically. The cooking/defrosting time starts to count down again when the door is closed and the [START] button is pressed.
- When cooking/defrosting is complete, open the door or press the [STOP] button and the time of day will reappear on the display, if the clock has been set.
- If you wish to know the power level during cooking, press the [MICROWAVE POWER] button. As long as your finger is pressing the [MICROWAVE POWER] button, the power level will be displayed.

IMPORTANT:

- Close the door after cooking/defrosting. Please note that the light will remain on when the door is open, this is for safety reason to remind you to close the door.
- If you cook food for more than the standard time (see chart below) using the same cooking mode, the oven's safety mechanisms automatically activate. The microwave power level will be reduced or the grill heating element will turn on and off.





Cooking Mode	Maximum Operation Time
Microwave 100 P	30 minutes
Grill cooking	99 min 50 sec, Intermittent operation, temperature controlled
Microwave + Grill Cooking	99 min 50 sec, Microwave and grill alternative works by time
Convection cooking	99 min 50 sec, Intermittent operation, temperature controlled
Microwave + Convection Cooking	99 min 50 sec, Microwave and Convection alternative works by time

Grill cooking

The grill at the top of the oven cavity has one power setting only. The grill is assisted by the turntable which rotates simultaneously to ensure even browning. Use the rack for grilling small items of food such as bacon, gammon and teacakes. Food can be placed either directly onto the rack, or into a flan dish/heat-resistant plate on the rack.

Example:

To grill for 20 minutes, using the [GRILL] button.

<p>1. Press the [GRILL] button once.</p>  x1	<p>2. Enter the required heating time by pressing the [10 min] button twice.</p>	<p>3. Press the [START/+30s] button to start the grilling. (The display will count down through the set grilling time.)</p>
		

Microwave and grill combination cooking

Using the microwave and grill together combines microwave power with the grill. It means to cook by Microwave power and Grill power alternately. The microwave power level for this function is P100.

The combination of microwave power with the grill reduces cooking time and provides a crisp, brown finish.

There are 2 choices for the combination:

COMBINATION 1 (Display: C-3)





The oven will operate in a 33 second cycle. For the first 18 seconds the microwave will turn on at 100%, for the next 15 seconds the grill will turn on. This cycle repeats until the end of the set cooking time. Use for fish and au gratin.

COMBINATION 2 (Display: C-4)

The oven will operate in a 33 second cycle. For the first 12 seconds the microwave will turn on at 100%, for the next 21 seconds the grill will turn on. This cycle repeats until the end of the set cooking time. Use for pudding omelets, and poultry.

Example:

To cook for 15 minutes, using [MICROWAVE+GRILL] with 55% time microwave power and 45% grill power (C-1).

<p>1. Press the [MICROWAVE+GRILL] button once.</p>  x1	<p>2. Enter the required heating time by pressing the [10 min] button once and the [1 min] button 5 times.</p>	<p>3. Press the [START/+30s] button to start the cooking. (The display will count down through the set cooking time.)</p>
		

Notes for grill and microwave+grill cooking:

- It is not necessary to preheat the grill.
- When browning foods in a deep container, place on the turntable.
- You may detect smoke or a burning smell when using the grill for the first time. This is normal and not a sign that the oven is faulty. To avoid this problem, when first using the oven, heat the oven without food for 20 minutes on grill.

IMPORTANT: During operation, to allow smoke or smells to disperse open a window or switch the kitchen ventilation on.

NOTE: When using the grill function, the grill will turn on and off at regular intervals to prevent overheating.



WARNING: The door, outer cabinet, oven cavity and accessories will become very hot during operation. To prevent burns, always use thick oven gloves.





Preheat/convection cooking

The convection cooking lets you cook the food as in a traditional oven. The temperature can be chosen from 140°C to 230°C. It is recommended to preheat the oven to the appropriate temperature before placing the food in the oven.

1. CONVECTION WITH PREHEATING FUNCTION

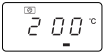
Example:





To cook for 20 minutes at 200°C, using the [PREHEAT] and the [CONVECTION] button.

<p>1. Press the [PREHEAT] button 7 times.</p>  x7	<p>2. Press the [START/+30s] button to start. When the preheating temperature is reached, the buzzer will sound twice.</p>	<p>3. Put the food into the oven and close the door. Enter the required heating time by pressing the [10 min] button twice.</p>	<p>4. Press the [START/+30s] button to start the cooking. (The display will count down through the set cooking time.)</p>
			

2. CONVECTION WITHOUT PREHEATING FUNCTION

Example:

To cook for 20 minutes at 200°C, using [CONVECTION] button.

<p>1. Press the [CONVECTION] button 7 times.</p>  x7	<p>2. Enter the required heating time by pressing the [10 min] button twice.</p>	<p>3. Press the [START/+30s] button to start the cooking. (The display will count down through the set cooking time.)</p>
		

Microwave and convection combination cooking

Using the microwave and convection modes together combines microwave power with the convection. It means to cook by Microwave power and Convection power alternately. The microwave power level for this function is P100 and the convection temperature is preset at 165°C. This mode makes cooking easier and faster as it uses fast microwave cooking and convection to crisp the food. There are 2 choices for the combination:

COMBINATION 1 (Display: C-1)



The oven will operate in a 29 second cycle. For the first 14 seconds the microwave will turn on at 100%, for the next 15 seconds the convection heater will turn on. This cycle repeats until the end of the set cooking time. Use for thick meat or whole chicken.

COMBINATION 2 (Display: C-2)

The oven will operate in a 29 second cycle. For the first 12 seconds the microwave will turn on at 100%, for the next 17 seconds the convection heater will turn on. This cycle repeats until the end of the set cooking time. Use for thin meat or chicken piece.

Example:

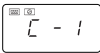
To cook for 15 minutes, using [MICROWAVE+CONVECTION] with 18% time microwave power and 52% grill power (C-1).

<p>1. Press the [MICROWAVE+CONVECTION] button once.</p>  x1	<p>2. Enter the required heating time by pressing the [10 min] button once and the [1 min] button 5 times.</p>	<p>3. Press the [START/+30s] button to start the cooking. (The display will count down through the set cooking time.)</p>
		

NOTES for CONVECTION and MICROWAVE+CONVECTION COOKING:

- You may detect smoke or a burning smell when using the convection for the first time. This is normal and not a sign that the oven is faulty. To avoid this problem, when first using the oven, heat the oven without food for 20 minutes on convection 230°C.

IMPORTANT: During operation, to allow smoke or smells to disperse open a window or switch the kitchen ventilation on.



WARNING: The door, outer cabinet, oven cavity and accessories will become very hot during operation. To prevent burns, always use thick oven gloves.

Other convenient functions

1. SEQUENCE COOKING

This function allows you to cook using up to 2 different stages which can include manual cooking time and mode and/or time defrost as well as weight defrost function. Once programmed there is no need to interfere with the cooking operation as the oven will automatically move onto the next stage. The audible signal will sound once after the first stage.

Note: Auto menu cannot be set as one of the multiple sequences.

Example: If you want to defrost the food for 5 minutes, then to cook with P80 microwave power for 7 minutes.

The steps are as follows:

- Press the [TIME DEFROST] button once, in the LED display will show 00:00.
- Enter the cooking time by pressing the [1 min] button 5 times.
- Input the power level (P80) by pressing the [MICROWAVE POWER] button 3 times.
- Enter the cooking time by pressing the [1 min] button 7 times.
- Press the [START] button once to start cooking.

2. +30s FUNCTION (Auto-start)

The [+30s] button allows you to operate the two following functions:

a. Direct start

You can directly start cooking on 100 P microwave power level for 30 seconds by pressing the [+30s] button.

b. Extend the cooking time

You can extend the cooking time during manual cooking, time defrost and auto menu operation for multiples of 30 seconds if the [+30s] button is pressed while the oven is in operation. During the weight defrost, the cooking time cannot be increased.

NOTE: The cooking time may be extended to a maximum of 99 minutes 50 seconds.

3. KITCHEN TIMER



You can use the kitchen timer for timing where microwave cooking is not involved for example to time boiled eggs cooked on conventional hob or to monitor the standing time for cooked/defrosted food.

Example:

To set the timer for 5 minutes.

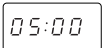
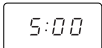

START/+30S

<p>1. Press the [KITCHEN TIMER] button once.</p> 	<p>2. Enter the desired time by pressing the [1 min] button 5 times.</p>	<p>3. Press the [START/+30s] button to start the timer.</p>	<p>4. Check the display. (The display will count down through the set cooking/defrosting time.)</p>
			

When the timer time arrives, the will beep 2 times and the LED will display then time of day.

You can enter any time up to 99 minutes, 50 seconds. To cancel the KITCHEN TIMER whilst counting down, simply press the [STOP] button.

NOTE: The KITCHEN TIMER function cannot be used whilst cooking.

4. CHILD LOCK

Use to prevent unsupervised operation of the oven by little children.

a. To set the CHILD LOCK:

Press and hold the [STOP] button for 3 seconds, a long beep will be heard and the display will indicate .

The oven is now in the CHILD LOCK mode.

b. To cancel the CHILD LOCK:

Press and hold the [STOP] button for 3 seconds until a long beep sound.

Note: If the button does not operate, open/close the door and try again.

5. LOCATION MEMORY

This is a function where the food location would be back to original cooking when finishing cooking.

Press [KITCHEN TIMER] button for 3 seconds to set or cancel this function. The default setting is ON.





When the LOCATION MEMORY function is in activate,  will be appeared at the end of cooking.

This function will not work if the door is opened or stop operation during cooking.

Defrosting by time

This function quickly defrosts food while enabling you to choose a suitable defrost period, depending on the food type. Follow the example below for details on how to operate this function. The time range is 0:01 – 99:50.

Example: To defrost the food for 10 minutes.

<p>1. Select the menu required by pressing the [TIME DEFROST] button once.</p>  x1	<p>2. Enter the cooking time by pressing the [10 min] button once.</p>	<p>3. Press the [START/+30s] button to start the defrosting. (The display will count down through defrosting time)</p>
		

Notes for time defrost:

- After cooking the audible signal will sounds five times and the LED will display the time of day, if the clock has been set. If the clock has not been set, the display will only show "0:00" when cooking is complete.
- The preset microwave power level is P30 and can not be changed.

Defrosting by weight

The microwave oven is pre-programmed with a timer and power level so that foods such as meat or seafood can be easily defrosted. The weight range for this is from 0.1kg – 2.0kg.

d-1: Defrost by weight (general)





d-2: Defrost by weight (ground meat)

d-3: Defrost by weight (seafood)

Follow the example below for details on how to operate these functions.

Example: To defrost a joint of meat weighing 1.2kg using.

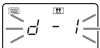
Place the food in a flat dish or alternatively on a microwave oven defrost rack on the turntable.

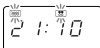
<p>1. Select the menu required by pressing the [WEIGHT DEFROST] button once.</p>  x1	<p>2. Enter the weight by pressing the [WEIGHT/POROTION] buttons until the desired weight is displayed</p> 	<p>3. Press the [START/+30s] button to start the defrosting. (The display will count down through defrosting time)</p>
		

Frozen foods are defrosted from -18°C.



Notes for weight defrost:

- Before freezing foods, ensure food is fresh and of good quality.
- Food weight should be rounded up to the nearest 0.1 kg, for example, 0.65kg to 0.7kg.
- If necessary, shield small areas of meat or poultry with flat pieces of aluminium foil. This will prevent the areas from becoming warm during defrosting. Ensure the foil does not touch the oven walls.

Cooking using the microwave sensor

The [MICROWAVE SENSOR MENU] button automatically work out the correct cooking mode and cooking time of the foods. Follow the example below for details on how to operate this function.

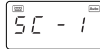
Example: To cook two baked potatoes (0.46kg) by using the microwave sensor menu function.

<p>1. Select the menu required by pressing the [MICROWAVE SENSOR MENU] button once.</p>  x1	<p>2. Press the [START/+30s] button to start the cooking.</p>
	





NOTES:

- For food weighing more or less than the weights/quantities given in the microwave sensor cooking chart, cook manually.

Cooking using the auto grill menu

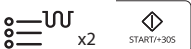
The [GRILL AUTO MENU] button automatically calculates the correct cooking mode and cooking time of the foods. Follow the example below for details on how to operate this function.

Example: To cook 500g of grilled chicken pieces by using the grill auto menu function.

<p>1. Select the menu required by pressing the [GRILL AUTO MENU] button twice and press the [START/+30s] button.</p>  x2	<p>2. Press [WEIGHT/POROTION UP/ DOWN] buttons to choose the required quantity.</p> 	<p>3. Press the [START/+30s] button to start the cooking. (The display will count down through cooking time)</p>
		



NOTES:

- The weight or quantity of the food can be input by pressing the WEIGHT/POROTION buttons until the desired weight/ quantity is displayed. Enter the weight of the food only. Do not include the weight of the container.
- For food weighing more or less than the weights/quantities given in the auto grill menu cooking chart, cook manually.

Cooking using the auto convection menu

The [CONVECTION AUTO MENU] button automatically work out the correct cooking mode and cooking time of the foods. Follow the example below for details on how to operate this function.

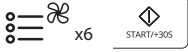
Example: To cook 250g of frozen onion rings by using the convection auto menu function.

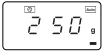
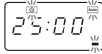
<p>1. Select the menu required by pressing the [CONVECTION AUTO MENU] button 6 times and press the [START/+30s] button.</p> 	<p>2. Press [WEIGHT/POROTION UP/DOWN] buttons to choose the required quantity.</p> 	<p>3. Press the [START/+30s] button to start the cooking. (The display will count down through cooking time)</p>
		

NOTES:

- The weight or quantity of the food can be input by pressing the WEIGHT/POROTION buttons until the desired weight/quantity is displayed. Enter the weight of the food only. Do not include the weight of the container.
- For food weighing more or less than the weights/quantities given in the auto convection menu cooking chart, cook manually.

Microwave sensor cooking chart

Display	Menu	WEIGHT/ PORTION / UTENSILS	Cooking Technique
SC-1	Baked Potato	1 - 3 potatoes (pieces) 1 potato = approx. 0.23kg (initial temp. room temp.) Kitchen paper	<ul style="list-style-type: none"> Pierce each potato with a fork 6 times spacing around surface. Place food around the edge of paper-towel-lined turntable, at least 2.5 cm apart. Do not cover.
SC-2	Frozen Pizza	200 - 400g (initial temp. -18°C) microwave safe dish	<ul style="list-style-type: none"> For reheating, purchased pizza. Remove all packaging and place food on microwave safe dish on turntable.
SC-3	Frozen Meal	200 - 600g (initial temp. -18°C) Microwave safe casserole with a lid or plastic wrap with pierced	<ul style="list-style-type: none"> All foods must be pre-cooked. Reheat in microwave safe container as purchased. If transferring food to dish, cover with pierced plastic wrap.
SC-4	Fresh Vegetables e.g. Brussel sprouts, green beans, peas, mixed vegetables, broccoli	200 - 600g (initial temp. room temp.) Microwave safe casserole with a lid or plastic wrap with pierced	<ul style="list-style-type: none"> All pieces should be the same size. Wash thoroughly, place food in a microwave safe casserole and add 1 tbsp (15 ml) of water per ½ cup (125 ml) of vegetables. Cover with a lid or pierced plastic wrap.
SC-5	Porridge	30 - 110g (initial temp. room temp.) Microwave safe casserole with a lid or plastic wrap with pierced	<ul style="list-style-type: none"> Cook oatmeal and water in container as 1:7 ratio. Cover with a lid or pierced plastic wrap.
SC-6	Fish	200 - 600g (initial temp. 5 - 10° C) Microwave safe casserole with a lid or plastic wrap with pierced	<ul style="list-style-type: none"> To cook fresh fillets or steaks of fish. Place food in a suitable size container, add 2 tbsp (30 ml) water. Cover with a lid or pierced plastic wrap.
SC-7	Chicken	200 - 600g (initial temp. 5° C) Microwave safe casserole with a lid or plastic wrap with pierced	<ul style="list-style-type: none"> To cook chicken piece. Place food in a suitable size container, add 2 tbsp (30 ml) water. Cover with a lid or pierced plastic wrap.
SC-8	Meat	200 - 600g (initial temp. 5 - 10° C) Microwave safe casserole with a lid or plastic wrap with pierced	<ul style="list-style-type: none"> Place food in a suitable size container, add 2 tbsp (30 ml) water. Cover with a lid or pierced plastic wrap.
SC-9	Auto Reheat	200 - 600g (initial temp. 5° C) Microwave safe casserole with a lid or plastic wrap with pierced	<ul style="list-style-type: none"> All foods must be pre-cooked. Reheat in microwave safe container as purchased. If transferring food to dish, cover with pierced plastic wrap.

Notes:

- The final temperature will vary according to the initial food temperature. Check food is piping hot after cooking. If necessary, you can extend the cooking manually.
- The results when using auto cook depend on variances such as the shape and size of the food and your personal preference as regards cooking results. If you are not satisfied with the programmed result, please adjust the cooking time to match your requirement.

Auto grill menu cooking chart

Display	Menu	WEIGHT/ PORTION / UTENSILS	Cooking Technique
AG-1	Grilled Steak	200, 300, 400, 500, 600g (initial temp. room temp.) Baking Tray+High Rack	<ul style="list-style-type: none"> • Slice steak with around 200 - 300g/piece and season with oil, salt, crushed black pepper. • Place food on the baking tray on the high rack.
AG-2	Grilled Chicken Pieces	200, 300, 400, 500, 600g (initial temp. room temp.) Baking Tray+High Rack	<ul style="list-style-type: none"> • After spreading the oil, salt, chopped pepper evenly on chicken breast, place on the baking tray on the high rack.
AG-3	Grilled Fish Steak	150, 200, 300, 400, 500g (initial temp. room temp.) Baking Tray+High Rack	<ul style="list-style-type: none"> • After spreading the chopped peppers evenly to the fish fillet, place on the baking tray on the high rack.
AG-4	Bacon	2 - 4 slices (initial temp. 5° C) Baking Tray+High Rack	<ul style="list-style-type: none"> • Place bacon slices on the baking tray on the high rack.
AG-5	Toast	1 - 3 pieces (initial temp. room temp.) High Rack	<ul style="list-style-type: none"> • Place 50g of bread slice on the high rack
AG-6	Sausages	2,4,8 pcs (initial temp. room temp.) Baking Tray+High Rack	<ul style="list-style-type: none"> • Place 50g of sausage piece on the baking tray on the high rack. • Turn over at 2/3 of total cooking time when the oven beeps.*1

*1: When the bleep sounds, open the door to turn the food over. If you do not open the door, the cooking will continue to cook until the end of the programmed time.

Notes:

- The final temperature will vary according to the initial food temperature. Check food is piping hot after cooking. If necessary, you can extend the cooking manually.
- The results when using auto cook depend on variances such as the shape and size of the food and your personal preference as regards cooking results. If you are not satisfied with the programmed result, please adjust the cooking time to match your requirement.



WARNING: The door, outer cabinet, oven cavity and accessories will become very hot during operation. To prevent burns, always use thick oven gloves.

Auto convection menu cooking chart

Display	Menu	WEIGHT/ PORTION / UTENSILS	Cooking Technique
AC-1	Frozen Oven French Fries	300g (initial temp. -18°C) Baking Tray+High Rack	<ul style="list-style-type: none"> Prepare the purchased frozen French fries and place on the baking tray on the high rack. Turn over food at 2/3 of total cooking time when the oven beeps.*1
AC-2	Roast Chicken	800, 1000, 1200, 1400g (initial temp. room temp.) Low Rack	<ul style="list-style-type: none"> After spreading oil, salt to the surface of the chicken. Place on the low rack. Turn over food at 2/3 of total cooking time when the oven beeps.*1
AC-3	Roast Beef/ Lamb	200, 300, 400, 500, 600g (initial temp. room temp.) Baking Tray+High Rack	<ul style="list-style-type: none"> Remove the surface of beef tender loin and spread oil, salt, crushed black pepper. After tie tightly with cotton rope, place on the baking tray on the high rack.
AC-4	Fish	200, 400, 600g (initial temp. room temp.) Baking Tray+High Rack	<ul style="list-style-type: none"> After spreading oil and salt on the fish and keep for 10 min. Place on the baking tray on the high rack.
AC-5	Frozen Chicken Nuggets	400g (initial temp. -18°C) Baking Tray+High Rack	<ul style="list-style-type: none"> Prepare the purchased frozen chicken nuggets. Place on the baking tray on the high rack. Turn over food at 2/3 of total cooking time when the oven beeps.*1
AC-6	Frozen Onion Rings	250g (initial temp. -18°C) Baking Tray+High Rack	<ul style="list-style-type: none"> Prepare the purchased frozen onion rings. Place on the baking tray on the high rack. Turn over food at 2/3 of total cooking time when the oven beeps.*1
AC-7	Frozen Snacks	100, 200, 300g (initial temp. -18°C) Baking Tray+High Rack	<ul style="list-style-type: none"> Prepare the purchased frozen snacks such as spring rolls with 25g of pieces. Place on the baking tray on the high rack. Turn over food at 2/3 of total cooking time when the oven beeps.*1

*1: When the beep sounds, open the door to turn the food over. If you do not open the door, the cooking will continue to cook until the end of the programmed time.

Notes:

- The final temperature will vary according to the initial food temperature. Check food is piping hot after cooking. If necessary, you can extend the cooking manually.
- The results when using auto cook depend on variances such as the shape and size of the food and your personal preference as regards cooking results. If you are not satisfied with the programmed result, please adjust the cooking time to match your requirement.



WARNING: The door, outer cabinet, oven cavity and accessories will become very hot during operation. To prevent burns, always use thick oven gloves.

Suitable ovenware

To cook/defrost food in a microwave oven, the microwave energy must be able to pass through the container to penetrate the food. Therefore it is important to choose suitable cookware.

Round/oval dishes are preferable to square/oblong ones, as the food in the corners tends to overcook. A variety of cookware can be used as listed below.

Cookware	Microwave Safe	Grill	Convection	Combination	Comment
Aluminium foil/Foil Containers	✓ / ✗	✓	✓	✓ / ✗	Small pieces of aluminium foil can be used to shield food from overheating. Keep foil at least 2 cm from the oven walls, as arcing may occur. Foil containers are not recommended unless specified by the manufacturer, e.g. Microfoil®, follow instructions carefully.
Browning dishes	✓ / ✗	✗	✗	✗	Always follow the manufacturers instructions. Do not exceed heating times given. Be very careful as these dishes become very hot.
China and ceramics	✓ / ✗	✗	✓	✓ (With Conv. only)	Porcelain, pottery, glazed earthenware and bone china are usually suitable, except for those with metallic decoration.
Glassware e.g. Pyrex®	✓	✓	✓	✓	Care should be taken if using fine glassware as it can break or crack if heated suddenly.
Metal	✗	✓	✓	✗	It is not recommended to use metal cookware when using microwave power as it will arc, which can lead to fire.
Plastic/ Polystyrene e.g fast food containers	✓	✗	✓	✓ / ✗	Care must be taken as some containers warp, melt or discolour at high temperatures.
Cling film	✓	✗	✗	✗	It should not touch the food and must be pierced to let the steam escape.
Freezer/ Roasting bags	✓	✗	✗	✗	Must be pierced to let steam escape. Ensure bags are suitable for microwave use. Do not use plastic or metal ties, as they may melt or catch fire due to the metal 'arcing'.
Paper - Plates, cups and kitchen paper	✓	✗	✗	✗	Only use for warming or to absorb moisture. Care must be taken as overheating may cause fire.
Straw and wooden containers	✓	✗	✗	✗	Always attend the oven when using these materials as overheating may cause fire.
Recycled paper and newspaper	✗	✗	✗	✗	May contain extracts of metal which will cause 'arcing' and may lead to fire.
High rack/Low rack/Baking tray	✗	✓	✓	✓	It is not recommended to use metal cookware when using microwave power as it will arc, which can lead to fire. May only be used when directed in the user manual.



WARNING: When heating food in plastic or paper containers, monitor the oven due to the possibility of ignition.

NOTE: Do not leave your oven unattended while in use.

Cleaning and care

CAUTION: DO NOT USE COMMERCIAL OVEN CLEANERS, STEAM CLEANERS, ABRASIVE, HARSH CLEANERS, ANY THAT CONTAIN SODIUM HYDROXIDE OR SCOURING PADS ON ANY PART OF YOUR MICROWAVE OVEN.

Before cleaning, make sure the oven cavity, door, oven cabinet and accessories are completely cool.

CLEAN THE OVEN AT REGULAR INTERVALS AND REMOVE ANY FOOD DEPOSITS - Keep the oven clean, or the oven could lead to a deterioration of the surface. This could adversely affect the life of the appliance and possibly result in a hazardous situation.

NOTE: When cooking, condensation can build up inside the oven cavity, cavity face and door. The amount of condensation will depend upon the temperature of the oven surfaces and the moisture content of the food being microwaved. Ensure that when you have finished cooking that any moisture which collects on these surfaces are wiped away with a soft, moisture absorbent cloth.

Oven exterior

The outside of your oven can be cleaned easily with mild soap and water. Make sure the soap is wiped off with a moist cloth, and dry the exterior with a soft towel.

Control panel

Open the door before cleaning to deactivate the control panel. Care should be taken in cleaning the control panel. Using a cloth dampened with water only, gently wipe the panel until it becomes clean.

Avoid using excessive amounts of water. Do not use any sort of chemical or abrasive cleaner.

Oven Interior

1. For cleaning, wipe any splatters or spills with a soft damp cloth or sponge after each use while the oven is still warm.

For heavier spills, use a mild soap and wipe several times with a damp cloth until all residues are removed. Built-up splashes may overheat and begin to smoke or catch fire, and cause arcing. Do not remove the waveguide cover.

2. Make sure that mild soap or water does not penetrate the small vents in the walls which may cause damage to the oven.

3. Do not use spray type cleaners on the oven interior.

4. Heat up your oven regularly by using the grill and heat the oven without food for 20 minutes on grill. Remaining food or fat splashed can cause smoke or bad smell.

Keep the waveguide cover clean at all times.

The waveguide cover is constructed from a fragile material and should be cleaned with care (follow the cleaning instructions above).

NOTE: Excessive soaking may cause disintegration of the waveguide cover.

The waveguide cover is a consumable part and without regular cleaning, will need to be replaced.

Accessories

The accessories like turntable, turntable support, racks and baking tray should be washed in a mild washing up liquid solution and dried. They are dishwasher safe.

Door

To remove all trace of dirt, regularly clean both sides of the door, the door seals and adjacent parts with a soft, damp cloth. Do not use abrasive cleaner.

NOTE: A steam cleaner should not be used.

Cleaning tip - For easier cleaning of your oven:

Place half a lemon in a bowl, add 300 ml (1/2 pint) water and heat on P100 for 7 - 8 minutes.

Wipe the oven clean using a soft, dry cloth.

Microwave cooking advice

Microwaves cook food faster than conventional cooking. It is therefore essential that certain techniques are followed to ensure good results. Many of the following techniques are similar to those used in conventional cooking.



WARNING: Liquids and foods must not be heated in sealed containers or jars/containers with lids on, as pressure will build up inside and may cause the jar/container to explode.

COOKING ADVICE NOTES:

- Always attend the oven when in use.
- Ensure that the utensils are suitable for use in a microwave oven.
- Refer to the charts in the cookbook section for recommended cooking times and power levels.
- Only use microwave popcorn within the recommended packaging (follow the manufacturers instructions). Never use oil unless specified by the manufacturer and never cook for longer than instructed.



WARNING: Follow instructions in the SHARP operation manual at all times. If you exceed recommended cooking times and use power levels that are too high, food may overheat, burn and, in extreme circumstances, catch fire and damage the oven.

Arrange

Place the thickest parts of food towards the outside of the dish. e.g. Chicken drumsticks.

Foods that are placed towards the outside of the dish will receive more energy, so cook quicker, than those in the centre.

Cover

Certain foods benefit from being covered during microwave cooking.

Use vented microwave cling film or a suitable lid.

Pierce

Foods with a shell, skin or membrane must be pierced in several places before cooking or reheating as steam will build up and may cause food to explode. e.g. Potatoes, Fish, Chicken, Sausages.

NOTE: Eggs should not be heated using microwave power as they may explode, even after cooking has ended. e.g. poached, fried, hard boiled.

Stir, turn and rearrange

For even cooking it is essential to stir, turn and rearrange food during cooking. Always stir and rearrange from the outside towards the centre.

Stand

Standing time is necessary after cooking so it enables the heat to disperse equally throughout the food.

Food Characteristics	
Composition	Foods high in fat or sugar (e.g. Christmas pudding, mince pies) require less heating time. Care should be taken as overheating can lead to fire. Bones in food conduct heat, making the food cook more quickly. Care must be taken so that the food is cooked evenly.
Density	Food density will affect the amount of cooking time needed. Light porous foods, such as cakes or bread, cook more quickly than heavy, dense foods, such as roasts and casseroles.
Quantity	The number of microwaves in your oven remains the same regardless of how much food is being cooked. The cooking time must be increased as the amount of food placed in the oven increases. e.g. Four potatoes will take longer to cook than two.
Size	Small foods and small pieces cook faster than large ones, as microwaves can penetrate from all sides to the centre. For even cooking make all the pieces the same size.
Shape	Foods which are irregular in shape, such as chicken breasts or drumsticks, take longer to cook in the thicker parts. For even cooking, place the thickest parts to the outside of the dish where they will receive more energy. Round shapes cook more evenly than square shapes when microwave cooking.
Temperature of food	The initial temperature of food affects the amount of cooking time needed. Chilled foods will take longer to cook than food at room temperature. The temperature of the container is not a true indication of the temperature of the food or drink. Cut into foods with fillings, for example jam doughnuts, to release heat or steam.



WARNING: Face & Hands: Always use oven gloves to remove food or cookware from the oven. Stand back when opening the oven door to allow heat or steam to disperse. When removing covers (such as cling film), opening roasting bags or popcorn packaging, direct steam away from face and hands.



WARNING: Check the temperature of food and drink, stir before serving. Take special care when serving to babies, children or the elderly. The contents of feeding bottles and baby food jars are to be stirred or shaken and the temperature is to be checked before consumption to avoid burns.

Defrosting advice

Using your microwave oven is the quickest defrosting method. It is a simple process but the following instructions are essential to ensure the food is thoroughly defrosted.

- Remove all packaging and wrapping before defrosting.
- To defrost food, use the Medium/Low or Defrost microwave power setting.
- Please refer to the further information below.

Rearrange

Foods that are placed towards the outside of the dish will defrost quicker than foods in the centre. It is therefore essential that the food is rearranged up to 4 times during defrosting.

Move closely packed pieces from the outside to the centre and rearrange over-lapping areas.

This will ensure that all parts of the food defrosts evenly.

Separate

Foods may be stuck together when removed from the freezer. It is important to separate foods as soon as it is possible during defrosting.

e.g. bacon rashers, chicken fillets.

Shield

Some areas of food being defrosted may become warm. To prevent them becoming warmer and starting to cook, these areas can be shielded with small pieces of foil, which reflect microwaves, e.g. legs and wings on a chicken.

Stand

Standing time is necessary to ensure food is thoroughly defrosted.

Defrosting is not complete once the food is removed from the microwave oven. Food must stand, covered, for a length of time to ensure the centre has completely defrosted.

Turn over

It is essential that all foods are turned over up to 4 times during defrosting.

This is important to ensure thorough defrosting.

Reheating advice

For the reheating of foods, follow the advice and guidelines below to ensure food is thoroughly reheated before serving.

Plated meals

Remove any poultry or meat portions, reheat these separately, see below.

Place smaller items of food to the centre of the plate, larger and thicker foods to the edge. Cover with vented microwave cling film and reheat on the Medium/Low microwave power level stir/rearrange halfway through reheating.

NOTE: Ensure the food is thoroughly reheated before serving.

Sliced meat

Cover with vented microwave cling film and reheat on the Medium/Low microwave power level. Rearrange at least once to ensure even reheating.

NOTE: Ensure the meat is thoroughly reheated before serving.

Poultry portions

Place thickest parts of the portions to the outside of the dish, cover with vented microwave cling film and reheat on the Medium microwave power level.

Turn over halfway through reheating.

NOTE: Ensure the poultry is thoroughly reheated before serving.

Casseroles

Cover with vented microwave cling film or a suitable lid and reheat on the Medium/Low microwave power level. Stir frequently to ensure even reheating.

NOTE: Ensure the food is thoroughly reheated before serving.

To achieve the best results when reheating, select a suitable microwave power level appropriate to the type of food. e.g. A bowl of vegetables can be reheated using the High microwave power level while a lasagne which contains ingredients that cannot be stirred, should be reheated using power level the Medium/Low microwave power level

NOTES:

- Remove food from foil or metal containers before reheating.
- Reheating times will be affected by the shape, depth, quantity and temperature of food together with the size, shape and material of the container.



WARNING: Never heat liquids in narrow-necked containers, as this could result in the contents erupting from the container and may cause burns.

- To avoid overheating and fire, special care must be taken when reheating foods with a high sugar or fat content, e.g. mince pies or Christmas pudding.
- Never heat oil or fat for deep frying as this may lead to overheating and fire.
- Canned potatoes should not be heated in the microwave oven, follow the manufacturer's instructions on the can.



WARNING: The contents of feeding bottles and baby food jars are to be stirred or shaken and the temperature is to be checked before consumption to avoid burns.

Troubleshooting

If you think the oven is not working properly there are some simple checks you can carry out yourself before calling an engineer. This will help prevent unnecessary service calls if the fault is something simple.

Follow this simple check below:

Place half a cup of water on the turntable and close the door. Set the timer to cook for 1 minute using P100 microwave power level.

1. Does the oven lamp come on when it is cooking?
2. Does the cooling fan work? (Check by placing your hand above the air vent openings).
3. After 1 minute does the audible signal sound?
4. Is the water in the cup hot?

Take the cup of water out of the oven and close the door. Set the oven to cook for 3 minutes using the grill.

5. After 3 minutes, does the grill heating element become red?

Set the oven to cook for 3 minutes using the convection on 230°C.

6. After 3 minutes, is the oven cavity hot?

If you answer "NO" to any question first check that the oven is plugged in properly and the fuse has not blown. If there is no fault with either, check against the troubleshooting chart below.



WARNING: Never adjust, repair or modify the oven yourself. It is hazardous for anyone other than a SHARP trained engineer to carry out servicing or repairs. This is important as it may involve the removal of covers that provide protection against microwave energy.

- The door seal stops microwave leakage during oven operation, but does not form an airtight seal. It is normal to see drops of water, light or feel warm air around the oven door. Food with a high moisture content will release steam and cause condensation inside the door which may drip from the oven.
- Repairs and Modifications: Do not attempt to operate the oven if it is not working properly.
- Outer Cabinet & Lamp Access: Never remove the outer cabinet. This is very dangerous due to high voltage parts inside which must never be touched, as this could be fatal.
Your oven is not fitted with a lamp access cover. If the lamp fails, do not attempt to replace the lamp yourself, call a SHARP approved service facility.