

W10 3033 DEL UK

12NC: 859991001720

EAN code: 8003437203206



SENSING THE DIFFERENCE

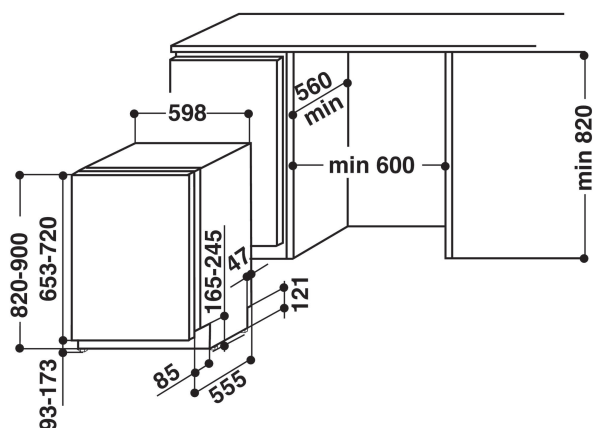

MAIN FEATURES

Construction type	Built-in
Installation type	Full-integrated
Type of control	Electronic
Type of control setting and signalling devices	-
Removable work top	N/A
Door decor panel	N/A
Main colour of product	Inox
Connection rating (W)	1900
Current (A)	13
Voltage (V)	220-240
Frequency (Hz)	50
Length of Electrical Supply Cord (cm)	130
Plug type	UK
Length inlet hose (cm)	155
Length outlet hose (cm)	150
Adjustable plinth	No
Height of removable worktop (mm)	0
Adjustable feet	Yes - all from front
Height of the product	820
Width of the product	595
Depth of the product	570
Depth with open door 90 degree (mm)	-
Minimum niche height	0
Maximum niche height	0
Minimum niche width	0
Maximum niche width	0
Niche depth	0
Net weight (kg)	35.50
Gross weight (kg)	37.50

TECHNICAL FEATURES

Automatic programmes	Yes
Maximum temperature for water intake (°C)	60
Start delay options	Continuous
Start delay time max. (h)	12
Progress indicator	-
Digital countdown indicator	No
Salt light indicator	Yes
Rinse aid light indicator	Yes
Safety device	N/A
Adjustable upper basket	Yes
Largest loadable dish upper basket (cm)	0
Largest loadable dish lower basket (cm)	0

PERFORMANCES

Energy efficiency class - NEW (2010/30/EC)	A+++
Energy consumption annual (kWh/annum) - NEW (2010/30/EC)	237
Duration of the left-on mode - NEW (2010/30/EC)	12
Power consumption in left-on mode - NEW (2010/30/EC)	5
Power consumption in off-mode - NEW (2010/30/EC)	0.50
Water consumption annual (l/annum) - NEW (2010/30/EC)	2660
Noise level (dB(A) re 1 pW)	43