



Register your new Bosch now:  
[www.bosch-home.com/welcome](http://www.bosch-home.com/welcome)



**Washing machine**  
**WAN...**



**BOSCH**

**en** Instruction Manual and Installation Instructions

## Your new washing machine

You have chosen a Bosch washing machine.

Please take a few minutes to read and become familiar with the advantages of your washing machine.

To meet the high quality demands required by Bosch, every washing machine that leaves our factory is carefully checked to ensure that it functions correctly and is in perfect condition.

For more information on our products, accessories, replacement parts and services, see our website [www.bosch-home.com](http://www.bosch-home.com) or contact our after-sales service centres.

If the operating and installation instructions describe different models, any differences will be pointed out at the relevant points in the text.



Read these operating and installation instructions before switching on the washing machine.

### Display rules

#### **Warning!**

This combination of symbol and signal word indicates a possibly dangerous situation. Not heeding the warning can cause death or injuries.

#### **Caution!**

This signal word indicates a possibly dangerous situation. Not heeding the caution can cause property and/or environmental damage.

### Note/tip

Information about the optimum use of the appliance/any other useful information.













#### **1. 2. 3. / a) b) c)**





The steps are represented by numbers or letters.

■ / -

Lists are represented by a small box or a dash.

# Contents

	<b>Intended use</b> . . . . .	4		<b>Detergent</b> . . . . .	25
	<b>Safety instructions</b> . . . . .	5		Correct selection of detergent . . . . .	25
	Children/people/pets . . . . .	5		Saving energy and detergent . . . . .	25
	Installation . . . . .	6		<b>Programme default settings</b> . . . . .	26
	Operation . . . . .	9		Temperature . . . . .	26
	Cleaning/Maintenance . . . . .	10		Spin speed . . . . .	26
	<b>Environmental protection</b> . . . . .	11		Ready in . . . . .	26
	Packaging/used appliance . . . . .	11		<b>Additional programme settings</b>	27
	Tips on economical use . . . . .	11		Speed Eco . . . . .	27
	<b>Positioning and connecting</b> . . . . .	12		Water Plus/Rinse Plus . . . . .	27
	Included with the appliance . . . . .	12		Easy-Iron . . . . .	28
	Safety instructions . . . . .	13		Prewash . . . . .	28
	Installation surface . . . . .	13		<b>Operating the appliance</b> . . . . .	28
	Installation on a base or a wooden joist floor . . . . .	14		Preparing the washing machine . . . . .	28
	Installation on a platform with drawer	14		Switching on the appliance/ selecting a programme . . . . .	28
	Installing the appliance in a kitchenette . . . . .	14		Changing the programme default settings . . . . .	28
	Removing the transport locks . . . . .	14		Selecting additional programme settings . . . . .	29
	Hose and cable lengths . . . . .	15		Placing laundry into the drum . . . . .	29
	Water inlet . . . . .	15		Measuring and adding detergent and care products . . . . .	29
	Water outlet . . . . .	16		Starting the programme . . . . .	30
	Levelling . . . . .	17		Childproof lock . . . . .	31
	Electrical connection . . . . .	18		Adding/removing laundry . . . . .	31
	Before washing for the first time . . . . .	18		Changing the programme . . . . .	31
	Transportation . . . . .	19		Cancelling the programme . . . . .	31
	<b>Getting to know the appliance</b> 20			Programme end during Rinse Stop . . . . .	32
	Washing machine . . . . .	20		Programme end . . . . .	32
	Control panel . . . . .	21		Removing laundry/switching off the appliance . . . . .	32
	Display panel . . . . .	21		<b>Sensors</b> . . . . .	33
	<b>Laundry</b> . . . . .	23		Automatic load sensing . . . . .	33
	Preparing the laundry . . . . .	23		Unbalanced load detection system . . . . .	33
	Sorting laundry . . . . .	23		<b>Appliance settings</b> . . . . .	33
	Starching . . . . .	24			
	Dyeing/bleaching . . . . .	24			
	Soaking . . . . .	24			

	<b>Cleaning and maintenance . . .</b>	<b>34</b>
	Machine housing/control panel . . . .	34
	Drum . . . . .	34
	Descaling. . . . .	35
	Detergent drawer and housing . . . .	35
	Drain pump is blocked . . . . .	36
	Drain hose at the siphon is blocked	37
	Filter in the water supply is blocked	37
	<b>Faults and what to do about them . . . . .</b>	<b>38</b>
	Emergency release . . . . .	38
	Information on the display panel . . .	39
	Faults and what to do about them. .	40
	<b>After-sales service . . . . .</b>	<b>42</b>
	<b>Technical data. . . . .</b>	<b>42</b>
	<b>Aqua-Stop warranty . . . . .</b>	<b>43</b>

---

## Intended use

- This appliance is intended for private domestic use only.
- Do not install or operate this appliance anywhere that is liable to experience frost and/or outdoor conditions. There is a risk that the appliance will be damaged if residual water in it freezes. If hoses freeze up, they may crack/burst.
- This appliance must only be used for washing domestic laundry, consisting of machine-washable items and hand-washable woollens (see label on item). Using the appliance for any other purpose is outside of the scope of its intended application and is forbidden.
- This appliance is suitable for operation with mains water and commercially available detergents and care products (must be suitable for use in washing machines).
- This appliance is intended for use up to a maximum height of 4000 metres above sea level.

### **Before you switch on the appliance:**

Check that there is no visible damage to the appliance. Do not operate the appliance if it is damaged. Should you have any problems, please contact your specialist dealer or our customer service.

Read and follow the operating and installation instructions and all other information provided with this appliance.

Retain the documents for subsequent use or for subsequent owners.

## Safety instructions

The following safety information and warnings are provided to protect you from injury and to prevent material damage to your surroundings.

It is nevertheless important to take the necessary precautions and to proceed with care when installing, maintaining, cleaning and operating the appliance.

### Children/people/pets

#### **Warning** **Risk of death!**

Children and other people who are unable to assess the risks involved when using the appliance may injure themselves or may find themselves in life-threatening situations. Therefore please note:

- The appliance may be used by children over the age of 8 years and by persons with reduced physical, sensory or mental capacity or by persons with a lack of experience or knowledge as long as they are supervised or have received instruction on how to use the appliance safely and they have understood the potential risks of using the appliance.
- Children must not play with this appliance.

- Do not allow children to clean or maintain this appliance unsupervised.
- Keep children under 3 years and pets away from this appliance.
- Do not leave the appliance unattended when children or other people who are unable to assess the risks are in the vicinity.

#### **Warning** **Risk of death!**

Children may lock themselves inside appliances and find themselves in a life-threatening situation.

- Do not position the appliance behind a door, as this may obstruct the appliance door or prevent it from opening completely.
- Once an appliance has reached the end of its life, pull the mains plug from the socket **before** severing the mains cable, and then destroy the lock on the appliance door.

**⚠ Warning**

**Risk of suffocation!**

If allowed to play with the packaging/plastic film or packing components, children may become caught in these or pull them over their heads and suffocate.

Keep packaging, plastic film and packing components away from children.

**⚠ Warning**

**Risk of poisoning!**

Detergents and care products may result in poisoning if consumed.

If accidentally swallowed, seek medical advice. Keep detergents and care products out of the reach of children.

**⚠ Warning**

**Risk of burns!**

When washing at high temperatures, the glass in the appliance door becomes hot. Stop children from touching the appliance door when it is hot.

**⚠ Warning**

**Eye/skin irritation!**

Contact with detergents or care products may cause eye/skin irritation.

Rinse eyes/skin thoroughly if they/it come(s) into contact with detergents or care products. Keep detergents and care products out of the reach of children.

## Installation

**⚠ Warning**

**Risk of electric shock/fire/  
material damage/damage to  
the appliance!**

If the appliance is not installed properly, this may lead to a dangerous situation. Ensure the following:

- The mains voltage on your power socket must match the rated voltage specified on the appliance (identification plate). The connected loads and the required fuse protection are specified on the identification plate.
- The mains plug and the protective contact socket must match and the earthing system must be correctly installed.
- The installation must have an adequate cross section.
- The mains plug must be freely accessible at all times. If this is not possible, in order to comply with the relevant safety regulations, a switch (all pole disconnection) must be built into the permanent installation in accordance with electrical installation regulations.

- If using a residual current circuit breaker, only use one that bears the following mark: . The presence of this mark is the only way to be sure that it fulfils all the applicable regulations.

### **Warning**

#### **Risk of electric shock/fire/material damage/damage to the appliance!**

If the appliance's mains cable is altered or damaged, this may result in electric shock, short circuiting or fire due to overheating.

The mains cable must not be kinked, crushed or altered, and must not come into contact with any heat sources.

### **Warning**

#### **Risk of fire/material damage/damage to the appliance!**

The use of extension cords or power strips may result in fire due to overheating or short circuiting.

Connect the appliance directly to an earthed socket that has been correctly installed. Do not use extension cords, power strips or multi-way couplers.

### **Warning**

#### **Risk of injury/material damage/damage to the appliance!**

- The appliance may vibrate or move when in operation, potentially resulting in injury or material damage. Place the appliance on a clean, even, solid surface and, using a spirit level to guide you, level it with the screw-in feet.
- If you take hold of any of the appliance's protruding parts (e.g. the appliance door) in order to lift or move it, these parts may break off and cause injury. Do not take hold of any of the appliance's protruding parts in order to move the appliance.

## **Warning**

### **Risk of injury!**

- The appliance is very heavy. Lifting it may result in injury. Do not lift the appliance on your own.
- The appliance has sharp edges on which you could cut your hands. Do not take hold of the appliance by its sharp edges. Wear protective gloves to lift it.
- If the hoses and mains cables are not correctly routed, they may constitute a tripping hazard, which may result in injury. Route hoses and cables such that they do not constitute a tripping hazard.

## **Caution!**

### **Material damage/damage to the appliance**

- If the water pressure is too high or too low, the appliance may not be able to operate properly, and it may also result in material damage or damage to the appliance. Make sure that the water pressure in the water supply facility is at least 100 kPa (1 bar), and does not exceed 1000 kPa (10 bar).

- If the water hoses are altered or damaged, this may result in material damage or damage to the appliance. The water hoses must not be kinked, crushed, altered or severed.
- The use of hoses supplied by other brands to connect to the water supply may result in material damage or damage to the appliance. Use the hoses supplied with the appliance or genuine spare part hoses only.
- The appliance is secured for transportation by transport locking devices. If the transport locking devices are not removed before the appliance is operated, this may result in damage to the appliance.

It is important to completely remove all transport locking devices before using the appliance for the first time. Make sure that you retain these transport locking devices separately. It is important to refit the transport locking devices if the appliance is to be transported, in order to prevent the appliance from being damaged in transit.



## Operation

### **Warning**

#### **Risk of explosions/fire!**

Laundry that has been pretreated with cleaning agents that contain solvents, e.g. stain remover/cleaning solvent, may cause an explosion in the drum. Rinse the laundry thoroughly with water before washing it in the machine.

### **Warning**

#### **Risk of poisoning!**

Poisonous fumes may be given off by cleaning agents that contain solvents, e.g. cleaning solvent.

Do not use cleaning agents that contain solvents.

### **Warning**

#### **Risk of injury!**

- If you support your weight/sit on the appliance door when it is open, the appliance may tip over, which may result in injury.  
Do not support your weight on the appliance door when it is open.
- If you climb onto the appliance, the worktop may break, which may result in injury.  
Do not climb onto the appliance.

- If you reach into the drum while it is still rotating, you risk injuring your hands. Wait until the drum has stopped rotating.

### **Warning**

#### **Risk of scalding!**

When washing at high temperatures, there is a risk of scalding if you come into contact with hot detergent solution (e.g. when draining hot detergent solution into a washbasin).

Do not reach into the hot detergent solution.

### **Warning**

#### **Eye/skin irritation!**

Detergent and care products may spray out if the detergent drawer is opened while the appliance is in operation. Rinse eyes/skin thoroughly if they/it come(s) into contact with detergents or care products. If accidentally swallowed, seek medical advice.

## Caution!

### Material damage/damage to the appliance

- If the amount of laundry in the appliance exceeds its maximum load capacity, it may not be able to operate properly, or this may result in material damage or damage to the appliance.  
Do not exceed the maximum load capacity of dry laundry. Make sure you comply with the maximum load capacities specified for each of the programs → Supplementary sheet for the operating and installation instructions.
- If you pour the wrong quantity of detergent or cleaning agent into the appliance, this may result in material damage or damage to the appliance.  
Use detergents/care products/cleaning agents and softeners in accordance with the manufacturers' instructions.

## Cleaning/Maintenance

### **Warning** **Risk of death!**

The appliance is powered by electricity. There is a risk of electric shock if you come into contact with live components. Therefore please note:

- Switch off the appliance. Disconnect the appliance from the power supply (pull out the plug).
- Never take hold of the mains plug with wet hands.
- When removing the mains plug from the socket, always take hold of the plug itself and never the mains cable, otherwise this may damage the mains cable.
- Do not make any technical modifications to the appliance or its features.
- Repairs and any other work on the appliance must only be conducted by our customer service or by an electrician. The same applies for replacing the mains cable (when necessary).
- Spare mains cables can be ordered from our customer service.

### **Warning** **Risk of poisoning!**

Poisonous fumes may be given off by cleaning agents that contain solvents, e.g. cleaning solvent.  
Do not use cleaning agents that contain solvents.

### **Warning** **Risk of electric shock/material damage/damage to the appliance!**

If moisture penetrates the appliance, this may cause it to short circuit.

Do not use a pressure washer, steam cleaner, hose or spray gun to clean your appliance.

**⚠ Warning**  
**Risk of injury/material damage/damage to the appliance!**

The use of spare parts and accessories supplied by other brands is dangerous and may result in injury, material damage or damage to the appliance. For safety reasons, use genuine spare parts and accessories only.

**Caution!**  
**Material damage/damage to the appliance**

Cleaning agents and agents for pretreating laundry (e.g. stain removers, prewash sprays, etc.) may cause damage if they come into contact with the surfaces of the appliance. Therefore please note:

- Do not allow these agents to come into contact with the surfaces of the appliance.
- Clean the appliance with nothing but water and a soft, damp cloth.
- Remove any detergent, spray or other residues immediately.



## Environmental protection

### Packaging/used appliance



Dispose of packaging in an environmentally-responsible manner.

This appliance is labelled in accordance with European Directive 2012/19/EU concerning used electrical and electronic appliances (Waste Electrical and Electronic Equipment - WEEE).

This directive specifies the framework for the return and recycling of used appliances as applicable throughout the EU.

### Tips on economical use

- For optimum energy and water savings, fill the appliance with the maximum amount of laundry for each programme.  
 Overview of programmes  
 → Supplementary sheet for the operating and installation instructions.
- Wash normally soiled laundry without a prewash.
- Save energy and detergent when washing lightly and normally soiled laundry.  
 → *"Detergent"* on page 25
- The temperatures which can be selected refer to the care labels on the textiles. The temperatures used in the machine may deviate from this to ensure you get the optimum combination of energy-saving and washing results.

**en** Positioning and connecting

- In order to save energy, the appliance switches to energy saving mode. The display panel lighting goes out after a few minutes and the Start Reload  button flashes. → "Display panel" on page 21
- If the laundry is subsequently dried in a tumble dryer, select the spin speed according to the tumble dryer manufacturer's instructions.



## Positioning and connecting

### Included with the appliance

#### Notes

- Check the machine for transport damage. Never use a damaged machine. If you have any complaints, contact the dealer from whom you purchased the appliance or our after-sales service.
- Moisture inside the drum is due to final testing.

The content of the drum and the hoses delivered with the appliance vary depending on the model.

#### ■ Standard

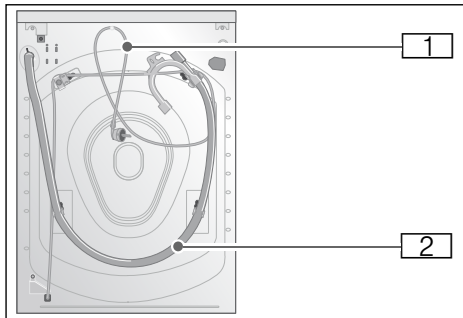



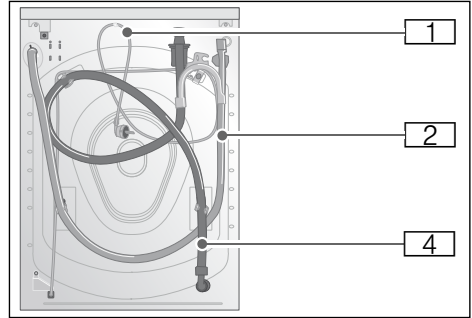

#### ■ Aqua-Secure

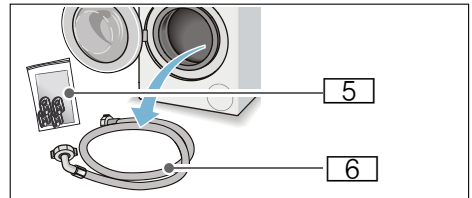
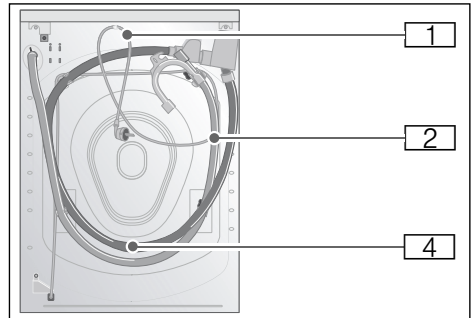

#### ■ Aqua-Stop



-  1 Mains cable
-  2 Water drain hose with elbow
-  3 Water supply hose on Aqua-Secure model
-  4 Water supply hose on Aqua-Stop model

- 5 Bag:
- Operating and installation instructions + supplementary sheet for the operating and installation instructions
  - After-sales service location directory\*
  - Warranty\*
  - Cover caps for openings after the transport locks have been removed
  - Measuring aid\* for liquid detergent
  - Adapter with sealing washer from 21 mm = 1/2" to 26.4 mm = 3/4" \*

6 Water supply hose on standard model

\* depending on the model

**In addition**, a hose clamp (24 - 40 mm diameter, available from specialist retailers) is required to connect the water drain hose to a siphon.

### Useful tools

- Spirit level for aligning
- Spanner with:
  - WAF13 for loosening the transport braces, and
  - WAF17 for aligning the appliance feet

## Safety instructions

### Warning

#### Risk of injury!

- The washing machine is very heavy. Be careful when lifting/transporting the washing machine; wear protective gloves.
- If the washing machine is lifted by its protruding parts (e.g. the washing machine door), the components may break off and cause injuries. Do not lift the washing machine by protruding parts.

- If the hose and mains cables are not routed properly, there is a risk of tripping and injury. Route hoses and cables in such a way that there is no risk of tripping.

### Caution!

#### Damage to the appliance

Frozen hoses may rip/burst. Do not install the washing machine in areas exposed to frost or outdoors.

### Caution!

#### Water damage

The connection points for the water supply hose and water drain hose are under high water pressure. To prevent leaks and water damage, you must follow the instructions in this section.

### Notes

- In addition to the safety information listed here, the local water and electricity supplier may have special requirements.
- If in doubt, have the appliance connected by a specialist.

## Installation surface

**Note:** The washing machine must be aligned in a stable manner so that it does not move around.

- The installation surface must be firm and level.
- Soft floors/floor coverings are not suitable.

## Installation on a base or a wooden joist floor

### Caution!

#### Damage to the appliance

The washing machine may "wander" and tip/topple from the base when spinning.

The feet of the appliance must be secured with holding brackets.  
Order no. WMZ 2200, WX 975600, Z 7080X0

**Note:** On wooden joist floors, install the washing machine:

- In a corner, if possible,
- On a water-resistant wooden board (min. 30 mm thick) which is screwed tightly to the floor.

## Installation on a platform with drawer\*

Platform order no.: WMZ 20490, WZ 20490, WZ 20520

## Installing the appliance in a kitchenette

### **Warning** **Risk of death!**

There is a risk of electric shock if you touch live components.  
Do not remove the appliance covering plate.

### Notes

- Recess width of 60 cm required.
- Only install the washing machine underneath a continuous worktop that is securely connected to adjacent cabinets.

## Removing the transport locks

### Caution!

#### Damage to the appliance

- The machine is secured for transportation using transport locks. If the transport locks are not removed, the machine may become damaged when it is operated. Before using the appliance for the first time, make sure that you completely remove all four transport locks. Keep the locks in a safe place.
- To prevent transport damage from occurring if the appliance is moved at a later date, you must refit the transport locks before transporting the appliance.

**Note:** Keep the screws and sleeves screwed together in a safe place.

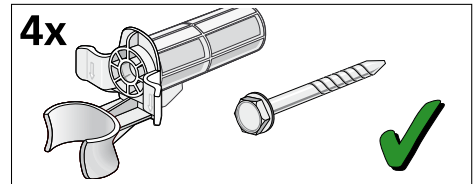

1. Take the hoses out of the holders.

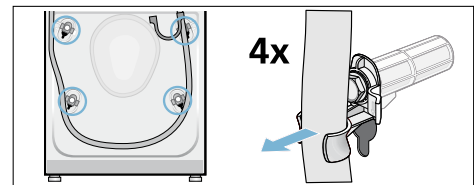

\* Depending on the model

- Remove the mains cable from the holders. Unscrew and remove all four transport lock screws. Remove the sleeves.

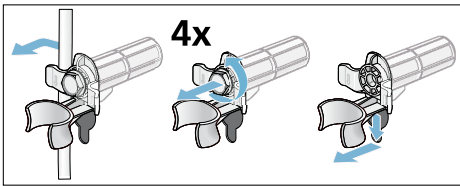

- Fit the covers. Lock the covers firmly in place by applying pressure to the snap-in hooks.

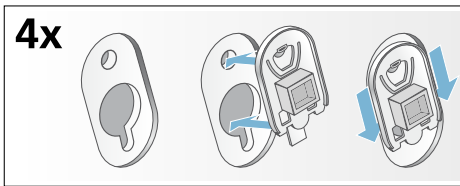

## Hose and cable lengths

- Left-hand connection

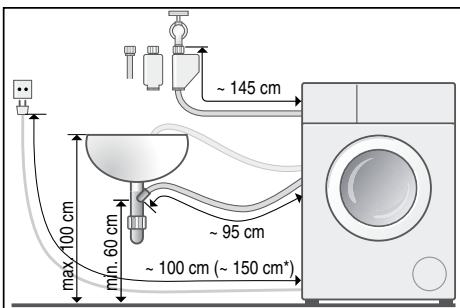

- Right-hand connection

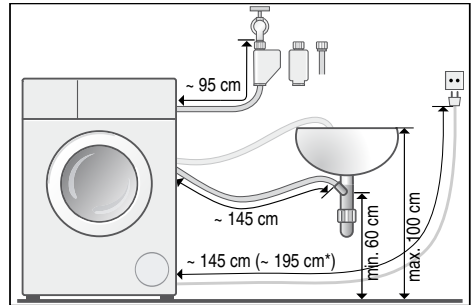

- \* depending on the model

**Tip:** The following are available from specialist retailers/our after-sales service:

- Extension for Aqua-Stop and cold water supply hose (approx. 2.50 m); order no. WMZ 2380, WZ 10130, Z 7070X0
- A longer supply hose (approx. 2.20 m) for standard models; individual component number for the after-sales service: 00353925

## Water inlet

### **⚠ Warning** **Risk of electric shock!**

The Aqua-Stop contains an electric valve. There is a risk of electric shock if you immerse the Aqua-Stop safety valve in water. Do not immerse the safety valve in water.

### Notes

- Only operate the washing machine using cold mains water.
- Do not connect the machine to the mixer tap of an unpressurised hot-water boiler.
- Do not use a used supply hose. Only use the supply hose supplied or one that was purchased from an authorised specialist retailer.
- Do not kink or squash the water supply hose.

## en Positioning and connecting

- Do not alter (shorten, cut through) the water supply hose (otherwise, its strength is no longer guaranteed).
- Only tighten the screw connections by hand. If the screw connections are tightened too much with a tool (pliers), the thread may become damaged.
- When connecting to a 21 mm = 1/2" tap, first fit an adapter\* with a sealing washer from 21 mm = 1/2" to 26.4 mm = 3/4".

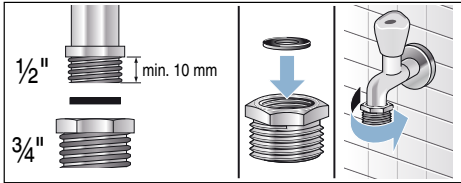

### Optimum water pressure in the supply network

**At least** 100 kPa (1 bar)

**Maximum** 1000 kPa (10 bar)

When the tap is open, the water flow is at least 8 l/min.

If the water pressure is higher than this, a pressure-reducing valve must be installed.

### Connection

Connect the water supply hose to the water tap (3/4" = 26.4 mm) and to the appliance (not necessary for Aqua-Stop models as this is permanently installed):

- Model: **Standard**

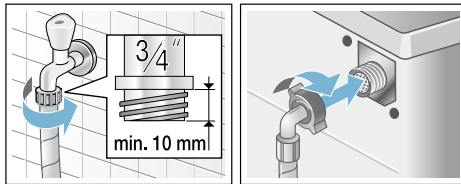

- Model: **Aqua-Secure**

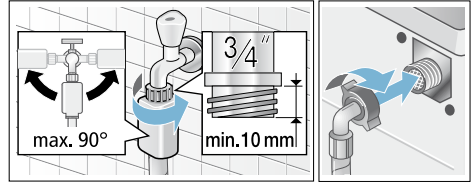

- Model: **Aqua-Stop**

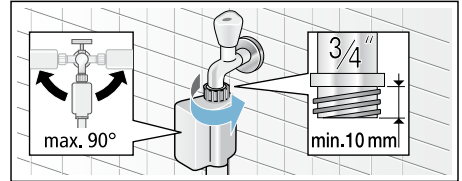

**Note:** Open the water tap carefully, checking the leak tightness of the connection points. The screw connection is under mains water pressure.

## Water outlet

### Caution! Water damage

If the drain hose slips out of the washbasin or the connection point during draining due to high water pressure, any escaping water may cause water damage. Secure the drain hose so that it cannot slip out.

### Notes

- Do not kink the water drain hose or put strain on it lengthways.
- Height difference between the installation surface and the drain: min. 60 cm, max. 100 cm

\* supplied depending on the model



You can lay the water drain hose as follows:

■ **Outlet in a sink**

**⚠ Warning**  
**Risk of scalding!**

When you are washing at high temperatures, there is a risk of scalding if you come into contact with hot water (e.g. when draining hot water into a washbasin). Do not reach into the hot water.

**Caution!**

**Damage to the appliance/fabrics**

If the end of the drain hose is immersed in the drained water, water may be sucked back into the appliance and may damage the appliance/fabrics.

Make sure that:

- The plug does not prevent drainage from the sink.
- The end of the drain hose is not immersed in the drained water.
- The water drains away quickly enough.

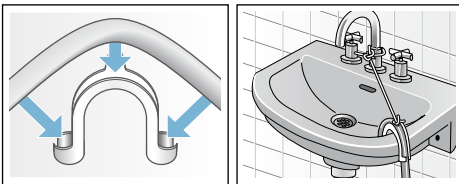

■ **Drainage into a siphon**

The connection point must be secured using a hose clamp with a diameter of 24-40 mm (available from specialist retailers).

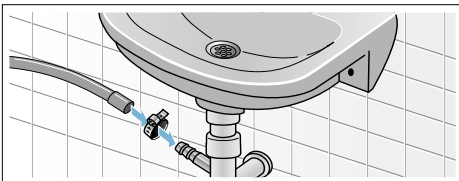

## Levelling

Level the appliance using a spirit level.

Incorrect levelling may result in intense noise, vibrations and "wandering".

1. Loosen the lock nuts using a wrench, by turning it in a clockwise direction.
2. Check the alignment of the washing machine with a spirit level, and adjust it if necessary. Change the height by turning the appliance feet. All four appliance feet must stand firmly on the ground.
3. Tighten the lock nut against the housing.  
In doing so, hold the foot tight and do not adjust its height.  
The lock nuts on all four appliance feet must be screwed tightly against the housing.

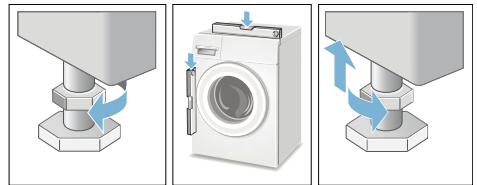

## Electrical connection

### **Warning** **Risk of death!**

There is a risk of electric shock if you touch live components.

- Never touch or hold the mains plug with wet hands.
- Only pull out the mains cable by the plug and never by the cable, as this could damage it.
- Never unplug the mains plug during operation.

Observe the following information and ensure that:

### Notes

- The mains voltage and voltage indicated on the washing machine (rating plate) are the same. The connected load and fuse required are specified on the rating plate.
- The washing machine is only connected to an alternating current supply via a properly installed earthed socket.
- The mains plug fits the socket.
- The cable cross-section is adequate.
- The earthing system is properly installed.
- The mains cable is only replaced by a qualified electrician (if this is necessary). Replacement mains cables are available from the after-sales service.
- No multiple plugs/couplings or extension cables are used.
- If an earth-leakage circuit breaker is used, only a type which displays the  symbol is used. Only this symbol guarantees compliance with the currently applicable regulations.
- The mains plug can be accessed at all times.
- The mains cable is not kinked, squashed, altered or cut through.

- The mains cable does not come into contact with heat sources.

## Before washing for the first time

The washing machine was thoroughly tested before leaving the factory. To remove any residues from the product and to remove water that may be left over from the test, run the first wash cycle **without** any laundry.

**Note:** The washing machine **must be correctly installed** and **connected**.  
→ *Page 12*

1. Check the appliance.  
**Note:** Never use a damaged machine. Inform the after-sales service.
2. Remove the protective foil from the worktop and the control panel.
3. Connect the mains plug.
4. Turn on the water tap.
5. Do not load any laundry. Close the door.
6. Depending on the model, run the **Drum Clean\*** or **Cottons 90 °C** programme.
7. Open the detergent drawer.
8. Pour approximately 1 litre of water into compartment **II**.
9. Pour standard detergent into compartment **II**.  
**Note:** To prevent foaming, only use half the amount of detergent recommended by the detergent manufacturer. Do not use detergents designed for wool or delicates.
10. Close the detergent drawer.
11. Press the Start Reload  button.
12. When the programme ends, switch off the appliance.

**Your washing machine is now ready to use.**

\* depending on the model

## Transportation

e.g. when moving home

### Preparatory work:

1. Turn off the water tap.
2. Reduce the water pressure in the supply hose.  
→ "Filter in the water supply is blocked" on page 37
3. Drain the remaining detergent solution.  
→ "Drain pump is blocked" on page 36
4. Disconnect the washing machine from the mains.
5. Remove the hoses.

### Installing the transport locks:

1. Remove the covers and keep them in a safe place.  
Use a screwdriver if necessary.

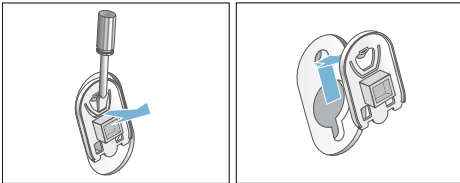

2. Insert all four sleeves.  
Clip the mains cable securely in the holders. Insert and tighten the screws.

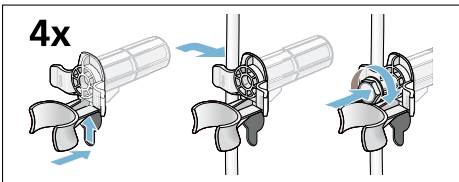

### Before switching on the appliance again:

#### Notes

- The transport locks **must** be removed.  
→ "Removing the transport locks" on page 14
- To prevent unused detergent from flowing straight into the drain during the next wash: Pour approx. 1 litre of water into compartment **II** and start the **Drain/Empty** programme.

## Getting to know the appliance

### Washing machine

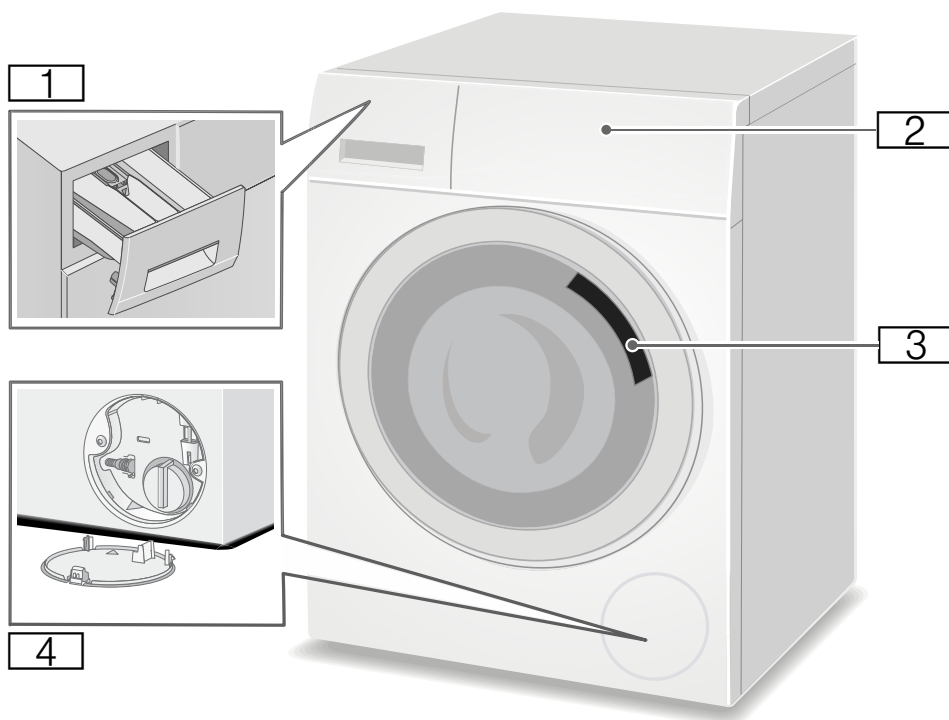

- 1** Detergent drawer
- 2** Operating/display panel
- 3** Loading door with door handle
- 4** Service flap

## Control panel

Control panel differs depending on the model



**1** Programmes → Supplementary sheet for the operating and installation instructions.





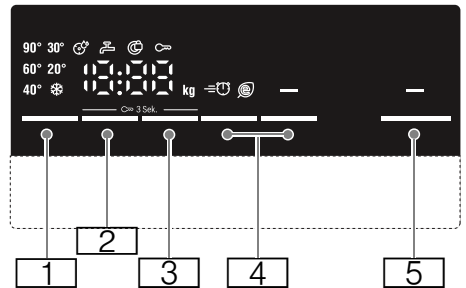
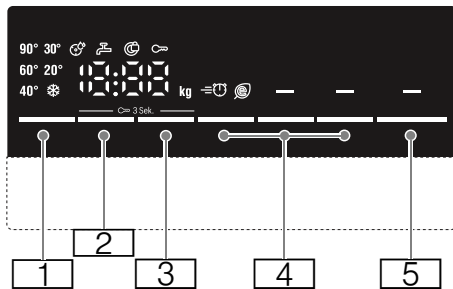

**2** Programme selector

**3** Display panel for settings and information







## Display panel

**Note:** The tables show possible setting options and information in the display panel; these differ depending on the model.



Buttons	Indicator/symbol/information on the display panel	Description
1	 - 90	Selectable <b>Temperature</b> In °C; * = cold
2	 - 1400**	Selectable <b>Spin speed</b> In rpm; 0 = no spin cycle, draining only; - - = Rinse Stop
3	e.g. 2:30  1-24 h	<b>Ready in</b> Select the program duration in h:min (hours:minutes) after selecting the program  End of program ("Ready in" time) after ...h (hours)
4	     	<b>Additional program settings:</b> → Page 27 Speed Eco Easy-Iron* Prewash* Water Plus/Rinse Plus*
5	Start Reload 	<b>Button</b> for starting, pausing (e.g. to add more laundry) and cancelling a program
* Depending on the model ** Depending on the selected program, settings and model		

### Other information on the display panel

Indicator/symbol/information on the display panel	Description
8** kg	<b>Recommended load</b>
	<b>Program progress:</b>
End	Program end
- - - 	Program end with Rinse Stop selected
	<b>Washing machine door</b> → "Adding/removing laundry" on page 31 → "Faults and what to do about them" on page 38
	<b>Tap</b> → "Faults and what to do about them" on page 38
	<b>Childproof lock</b> → "Childproof lock" on page 31 → "Faults and what to do about them" on page 38
	<b>Indicator light for the Drum Clean program*</b> → "Information on the display panel" on page 39 → "Appliance settings" on page 33
E:--	<b>Fault code</b> → "Information on the display panel" on page 39
0-4	<b>Signal setting</b> → "Appliance settings" on page 33
* Depending on the model ** Depending on the selected program, settings and model	

**Note: Energy saving mode**

In order to save energy, the appliance switches to energy saving mode. The display lighting goes out after a few minutes and the Start Reload  button flashes. To activate the lighting, press any button. The energy saving mode is not activated if a programme is running.



## Laundry

### Preparing the laundry

**Caution!****Damage to the appliance/fabrics**

Foreign objects (e.g. coins, paper clips, needles, nails) may damage the laundry or components in the washing machine.

Therefore, note the following tips when preparing your laundry:

- Empty any pockets.

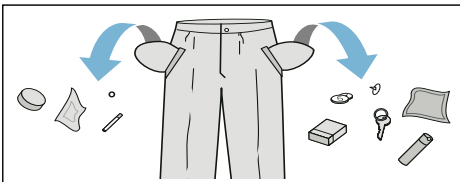

- Check for metal items (paper clips, etc.) and remove them.
- Wash delicates in a laundry bag (tights, underwired bras, etc.).

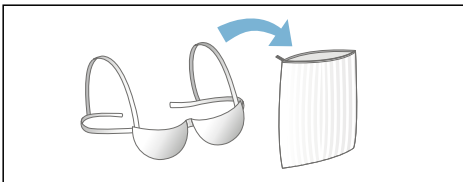

- Remove curtain fittings or place curtains in a laundry bag.

- Close any zips, button up any cover buttons.
- Brush sand out of pockets and collars.

### Sorting laundry

Sort your laundry according to the care instructions and manufacturer's information on the care labels, depending on:

- Type of fabric/fibre
- Colour

**Note:** Laundry can discolour or not be cleaned correctly. Wash white and coloured items separately. Wash new coloured items separately the first time you wash them.

- Soiling





Wash laundry with the same level of soiling together.

Some examples of soiling levels:

→ *"Saving energy and detergent"* on page 25

- **Light:** Do not prewash; select the **Speed** setting if necessary
- **Normal**
- **Heavy:** Load less laundry; select a programme with prewash
- **Stains:** Remove/pretreat stains while they are fresh. Firstly, dab with soapy water; do not rub. Then wash the items of laundry with the appropriate programme. Stubborn or dried-in stains can sometimes only be removed by washing several times.

- Symbols on the care labels  
**Note:** The numbers in the symbols indicate the maximum washing temperature that may be used.

-  Suitable for normal washing process;  
e.g. Cottons programme
-  A gentle washing process is required;  
e.g. Easy-Care programme
-  An especially gentle washing process is required; e.g. Delicate/Silk programme
-  Suitable for washing by hand; e.g. Wool programme
-  Do not machine wash.

## Starching

**Note:** Laundry must not be treated with fabric softener.

Starching with liquid starch is possible in programmes such as **Rinse** and **Cottons**. Dose starch into compartment  (if required, clean it beforehand) in accordance with the manufacturer's instructions.

## Dyeing/bleaching

Dye should only be used in normal household quantities. Salt may damage stainless steel. Always follow the dye manufacturer's instructions.

Do **not** use the washing machine to bleach clothes.

## Soaking

1. Pour soaking agent/detergent into compartment **II** in accordance with the manufacturer's instructions.
2. Select the desired programme.
3. Press the Start Reload  button to start the programme.
4. After approx. ten minutes, press the Start Reload  button to pause the programme.
5. After the desired soaking time, press the Start Reload  button again to continue or change the programme.

### Notes

- Load laundry of the same colour.
- No additional detergent is required; the soaking solution is used for washing.



## Detergent

### Correct selection of detergent

The care label is crucial for selecting the correct detergent, temperature and treatment of the laundry. → See also [www.sartex.ch](http://www.sartex.ch)

If you visit [www.cleanright.eu](http://www.cleanright.eu), you will find further information on detergents, care products and cleaning agents for domestic use.

- **Standard detergent with optical brighteners**  
Suitable for boil-washable white laundry made from linen or cotton  
Programme: Cottons/  
cold - max. 90 °C
- **Detergent for colours without bleach or optical brighteners**  
Suitable for coloured laundry made from linen or cotton  
Programme: Cottons/  
cold - max. 60 °C
- **Detergent for colours/delicates without optical brighteners**  
Suitable for coloured laundry made from easy-care fibres, synthetic fibres  
Programme: Easy-Care/  
cold - max. 60 °C
- **Detergent for delicates**  
Suitable for delicate, fine fabrics, silk or viscose  
Programme: Delicate/Silk/  
cold - max. 40 °C
- **Detergent for woollens**  
Suitable for wool  
Wool programme/  
cold - max. 40 °C

### Saving energy and detergent

For light and normal soiling, you can save energy (lower washing temperature) and detergent.

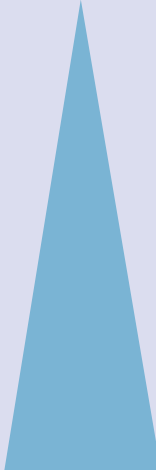
Saving	Soiling/note
Reduced temperature and detergent quantity as per the recommended dosage	<p><b>Light</b> No visible dirt or stains. Clothing has taken on some body odour, e.g.:</p> <ul style="list-style-type: none"> <li>■ Light summer/sports clothing (worn for a few hours)</li> <li>■ T-shirts, shirts, blouses (worn for up to one day)</li> <li>■ Guest bed linen and hand towels (used for one day)</li> </ul>
	<p><b>Normal</b> Visible dirt or a few light stains, e.g.:</p> <ul style="list-style-type: none"> <li>■ T-shirts, shirts, blouses (sweat soaked, worn a few times)</li> <li>■ Towels, bedding (used for up to one week)</li> </ul>
	<p><b>Heavy</b> Dirt and/or stains clearly visible, e.g. tea towels, baby items, work clothing</p>
Temperature as per the care label and detergent quantity as per the recommended dosage for heavy soiling	

**Note:** When measuring the amount of all detergents/additives/care products and cleaning agents, please always check the manufacturer's instructions and information.  
→ "Measuring and adding detergent and care products" on page 29

## **P+** Programme default settings

The programme default settings for all programmes are preset at the factory and are displayed in the display panel after the programme is selected.

You can change the default settings by repeatedly pressing the corresponding buttons until the required settings are displayed in the display panel.

**Note:** Pressing and holding the button automatically runs through the setting values until the last one. Press the button once more and you will be able to change the setting values again.

The available settings vary depending on the model.

You can find an overview of all settings available for selection in each programme on the supplementary sheet for the operating and installation instructions.

### Temperature

(°C, Temp. °C, Temperature)

Depending on what stage the programme is in, you can change the set temperature before and at the beginning of the programme.

#### Notes

- The maximum temperature that can be set depends on the programme that has been selected.
- The remaining time may be increased or decreased according to the changed temperature values.

### Spin speed

(Ⓢ, Ⓢ rpm, Spin speed)

Depending on what stage the programme is in, you can change the

spin speed (in rpm; revolutions per minute) before and during the programme.

**Setting** : The rinsing water is drained but there is no spin. The laundry stays wet inside the drum, e.g. for items that should not be spun.

**Setting** - - -: (Rinse Stop) = no final spin. The laundry stays in the water after the final rinse.

You can select "Rinse Stop" to prevent creasing if the laundry will not be taken out of the washing machine immediately after the programme has ended.  
→ "Programme end during Rinse Stop" on page 32

**Note:** The maximum speed that can be set depends on the model and programme that has been selected.

### Ready in

(Ⓢ, Ⓢ Finish in, Finished in, Ready in)



**Before starting the programme**, you can preselect the programme end ("Ready in" time) in hourly increments (h = hour) up to a maximum of 24 hours.

To do this:

1. Select a programme.  
The programme duration is displayed for the selected programme, e.g. **2:30** (hours:minutes).
2. Press the **Ready in** button repeatedly until the required number of hours is displayed.
3. Press the Start Reload  button.  
The door will be locked.  
The selected number of hours (e.g. **8 h**) is shown in the display panel and counts down until the wash programme starts. The duration of the programme is then displayed.

**Note:** The programme duration is included in the selected "Ready in" time.

**During the timer count-down**, you can change the preselected number of hours as follows:

1. Press the Start Reload  button.
2. Use the **Ready in** button to change the number of hours.
3. Press the Start Reload  button.

**During the timer count-down** you can add or remove laundry as required.

**Note:** The length of the programme is automatically adjusted when the programme is running. Certain factors can affect the programme length, e.g.:





- Programme settings,
- Detergent dosage (additional rinse cycles if required due to foaming),
- Load size/type of textiles (longer washing for higher load and for textiles which absorb more water),
- Imbalances (e. g. due to fitted sheets) are offset with several start-ups of spin cycles,
- Fluctuations in power supply,
- Water pressure (infeeding speed).

## **P+** Additional programme settings

The available settings vary depending on the model.

You can find an overview of all settings available for selection in each programme on the supplementary sheet for the operating and installation instructions.

## Speed Eco

(, ,  Speed/ Eco Perfect, Speed Eco)

Button with two possible settings for adapting the selected programme:

### ■ Speed

Washing in a shorter time while achieving a washing result that is consistent with, but uses more energy than, the selected programme, without the Speed setting.

**Note:** Do not exceed the maximum load.

### ■ Eco

Energy-optimised washing by reducing the temperature and increasing programme duration while achieving a washing result that is consistent with the selected programme, without the Eco setting.

If you press the **Speed Eco** button once, you select the **Speed** setting. If you press the button again, the **Eco** setting is activated. The respective symbol is shown in the display when the setting is activated. If you press the button again, no setting is activated.

## Water Plus/Rinse Plus

(, Water+, Rinse+, Aqua Plus, Water Plus, Rinse Plus)

Setting depending on the model

Increased water level and additional rinse cycle; extended washing time. For areas with very soft water or for further enhancing the spin result.

## Easy-Iron

(,  Less Ironing, Easy-Iron)

Setting depending on the model

Reduces creasing thanks to a special spin sequence followed by fluffing and reduced spin speed.

**Note:** The laundry's residual moisture is increased.

## Prewash

(, Prewash)

Setting depending on the model

For heavily soiled laundry.

There will be a prewash cycle at a low temperature before the main wash cycle.

**Note:** Pour detergent into compartment **I** for the prewash cycle and into compartment **II** for the main wash cycle.



## Operating the appliance

### Preparing the washing machine

#### Notes

- The washing machine **must be correctly installed and connected**.  
→ *"Positioning and connecting"* on page 12
- Before washing for the first time, run a wash cycle without laundry.  
→ *"Before washing for the first time"* on page 18

1. Connect the mains plug.
2. Turn on the water tap.
3. Open the door.

4. Check that the drum is completely drained. Drain if necessary.

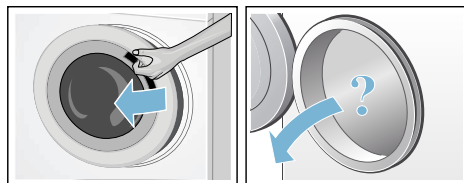

### Switching on the appliance/ selecting a programme

**Note:** If you have activated the childproof lock, you must first deactivate it before you can set a programme.  
→ *"Childproof lock"* on page 31

Use the programme selector to select the programme you require. The programme selector can be rotated in either direction.

The display alternately shows the programme length and the maximum load (when the door is open).

### Changing the programme default settings

You can use the default settings or change them.

To do this, repeatedly select the corresponding button until the required setting is displayed.

The settings are activated without needing to be confirmed.

They are not saved when the appliance is switched off.

→ *"Programme default settings"* on page 26

Overview of programmes →  
Supplementary sheet for the operating and installation instructions.

## Selecting additional programme settings

By selecting additional settings, you can better adapt the washing process to your items of laundry.

The settings can be selected or deselected depending on the programme progress.

The indicator lamp for the button lights up if a setting is active.

The settings are not saved when the appliance is switched off.

→ "Additional programme settings" on page 27

Overview of programmes → Supplementary sheet for the operating and installation instructions.

## Placing laundry into the drum

### **Warning** **Risk of death!**

Items of laundry pretreated with cleaning agents that contain solvents, e.g. stain remover/cleaning solvent, may cause an explosion after being loaded into the washing machine. Hand-rinse items of laundry thoroughly beforehand.

### Notes

- Mix items of laundry of varying sizes. Laundry items of different sizes distribute themselves better during the spin cycle. Individual items of laundry may lead to imbalances.
  - Observe the specified maximum load. Overfilling has a negative impact on the washing result and promotes creasing.
1. Place presorted items of laundry unfolded in the washing drum.

2. Make sure that no items of laundry are trapped between the washing machine door and the rubber seal, and close the door.

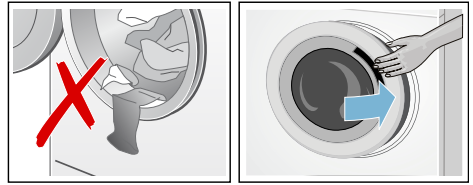

The Start Reload  button indicator lamp flashes to indicate that the washing programme can be started. It is possible to change the settings.

→ "Programme default settings" on page 26

→ "Additional programme settings" on page 27

## Measuring and adding detergent and care products

### Caution!

#### Damage to the appliance

Cleaning agents and agents for pre-treating laundry (e.g. stain removers, prewash sprays, etc.) may cause damage if they come into contact with the surfaces of the washing machine. Do not allow these agents to come into contact with the surfaces of the washing machine. If necessary, immediately wipe away spray residue and other residues/droplets with a damp cloth.

### Dosing

Dose the detergents and care products according to:

- Water hardness (ask your water supply company)
- The manufacturer's instructions on the packaging
- The amount of laundry
- Soiling

## Filling

### **Warning** **Eye/skin irritation!**

Detergents and care products may spray out if the detergent drawer is opened while the machine is in operation.

Open the drawer carefully.

Rinse eyes/skin thoroughly if they come into contact with detergents or care products.

If accidentally swallowed, seek medical advice.

**Note:** Dilute viscous fabric softener and fabric conditioner with a little water. This prevents blockages in the washing machine's piping.

Pour the detergent and care products into the appropriate compartments:

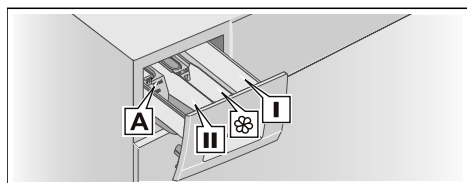

Measuring aid **A\*** For liquid detergent

Compartment **II** Detergent for the main wash, water softener, bleach, stain remover

Compartment  Fabric softener, liquid starch; do not exceed **max.**

Compartment **I** Detergent for prewash

\* depending on the model

1. Pull out the detergent drawer as far as possible.
2. Add detergent and/or care products.
3. Close the detergent drawer.

## Measuring aid\* for liquid detergent

Position the measuring aid for dosing the correct amount of liquid detergent:

1. Pull out the detergent drawer. Press down the insert and fully remove the drawer.
2. Slide the measuring aid forwards, fold it down and click it into place.
3. Reinsert the drawer.

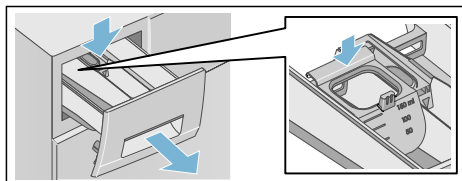

**Note:** Do not use the measuring aid for gel detergents and washing powder, or for programmes with prewash or when the "Ready in" time is selected.

**For models without a measuring aid,** pour the liquid detergent into the appropriate dispenser and place it in the drum.

## Starting the programme

Press the Start Reload  button. The indicator lamp lights up and the programme starts.

The display panel shows the "Ready in" time while the programme is running or the programme duration and the programme progress symbols once the wash cycle has started.

→ "Display panel" on page 21

\* depending on the model

## Childproof lock

(∞ 3 sec.)

You can lock the washing machine to prevent the functions you have set from being changed inadvertently.

To **activate/deactivate**, press and hold the **Spin speed** and **Ready in** buttons at the same time for approx. three seconds. The ∞ symbol appears in the display panel.

- ∞ lights up: The childproof lock is active.
- ∞ flashes: The childproof lock is active and the programme selector has been adjusted. If you reset the programme selector to the initial programme, the symbol lights up again.

### Notes

- To avoid the programme to terminate, do not turn the programme selector beyond the off position. If the appliance is switched off while the programme is running and childproof lock is activated, the programme continues when the appliance is switched back on.
- To remove the laundry at the end of the programme, deactivate the childproof lock.
- The childproof lock remains active, even once the washing machine has been switched off.

## Adding/removing laundry

After starting the programme, you can add or remove laundry as required.

Press the Start Reload ▷||| button to pause the programme. The Start Reload ▷||| button indicator lamp flashes and the machine checks whether it is possible to add or remove laundry.

- If the ∞ symbol disappears in the display panel, the washing machine door is unlocked. You can add or remove laundry.

### Notes

- Do not leave the door open for too long when adding/removing laundry as water from the laundry may leak out.
- The load display is not active during reloading.

Press the Start Reload ▷||| button to continue the programme.

- If the ∞ symbol lights up in the display panel, it is not possible to add or remove laundry.

**Note:** For safety reasons, the door remains locked when the water level or temperature is high, or while the drum is turning.

## Changing the programme

If you have started the wrong programme by mistake, you can change it as follows:

1. Press the Start Reload ▷||| button.
2. Select another programme.
3. Press the Start Reload ▷||| button. The new programme starts from the beginning.

## Cancelling the programme

For programmes at high temperature:

1. Press the Start Reload ▷||| button.
2. To cool down laundry: Select **Rinse**.
3. Press the Start Reload ▷||| button.

For programmes at low temperature:

1. Press the Start Reload ▷||| button.
2. Select **Drain/Empty**.
3. Press the Start Reload ▷||| button.

## Programme end during Rinse Stop

- - - ⑥ appears in the display panel and the indicator lamp of the Start Reload ▷ button flashes.

Continue the programme by:

- Pressing the Start Reload ▷ button (the laundry will be spun with the default spin speed setting\*) or
- Selecting a spin speed or setting the programme selector to **Drain/Empty** and then pressing the Start Reload ▷ button.

## Programme end

*End* appears in the display panel and the indicator lamp of the Start Reload ▷ button goes out.

## Removing laundry/switching off the appliance

1. Turn the programme selector to the off position. The appliance is switched off.
2. Open the door and remove the laundry.
3. Turn off the tap.  
**Note:** Not required for Aqua-Stop models.

### Notes

- Always wait until the programme ends, as the appliance could still be locked.
  - At the end of the programme, the appliance switches to energy saving mode. The lighting goes out and the Start Reload ▷ button flashes. Press any button to activate the panel.
- \* depending on the chosen programme → Overview of programmes on supplementary sheet for the operating and installation instructions

- Do not leave any items of laundry in the drum. They may shrink in the next wash or discolour another item.
- Remove any foreign objects from the drum and the rubber seal – risk of rusting.

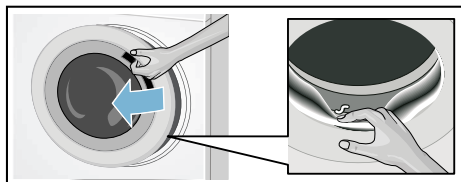

- Wipe the rubber seal and the washing machine door dry.
- Leave the door and detergent drawer open so that any residual water can evaporate.

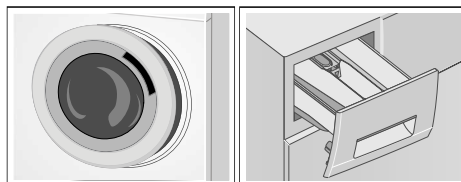



## Sensors

### Automatic load sensing

The automatic load-sensing function perfectly adapts the water consumption to each programme depending on the type of fabric and the load.

### Unbalanced load detection system

The automatic unbalanced load detection system detects imbalances and ensures even distribution of the laundry by repeatedly starting and stopping the drum spinning.

If the laundry is extremely unevenly distributed, the spin speed is reduced or the spin cycle is not performed for safety reasons.

**Note:** Place large and small items of laundry evenly in the drum.  
→ *"Faults and what to do about them"* on page 38

## Appliance settings

You can change the following settings:

- The volume of the information signals (e.g. at the end of the programme) and/or
- The volume of the button signals and/or
- Switch on or off the drum clean reminder\*.

In order to change these settings you will need to activate the setting mode.

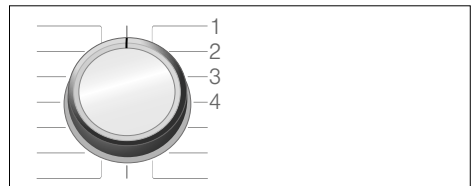

1/2/3/4... positions on the programme selector

### Activating the setting mode

1. Turn the programme selector to position 1. The washing machine is switched on.
2. Press the Start Reload  button and, at the same time, turn the programme selector clockwise to position 2. Release the button.

The setting mode is activated and the preset volume for the information signals appears in the display panel (e.g. at the end of the programme).

### Changing the volume

- To change the volume of the **information signals**, use the **Ready in** button while the programme selector remains at position 2.
- To change the volume of the **button signals**, rotate the programme selector to position 3. Use the **Ready in** button again to change the volume.

\* depending on the model

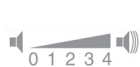

0 = off, 1 = quiet,  
2 = medium, 3 = loud,  
4 = very loud

### Switching on or off the drum clean reminder\*

To switch on/off the drum clean reminder, rotate the programme selector to position 4. Use the **Ready in** button to switch the reminder on or off.



If the setting is activated, an acoustic signal is heard.

### Exiting setting mode

You can now end the process and set the programme selector to the off position. The settings are saved.



## Cleaning and maintenance



### Warning

#### Risk of death!

There is a risk of electric shock if you touch live components.  
Switch off the appliance and disconnect the mains plug.



### Warning

#### Risk of poisoning!

Toxic vapours can be produced by cleaning agents that contain solvents, e.g. cleaning solvent.  
Do not use cleaning agents that contain solvents.

### Caution!

#### Damage to the appliance

Cleaning agents that contain solvents, e.g. cleaning solvent, can damage surfaces and components in the machine.

Do not use cleaning agents that contain solvents.

#### Prevent detergent residue from building up and odours from forming by following these instructions:

### Notes

- Ensure the room in which the washing machine is set up is well ventilated.
- Leave the door and detergent drawer open slightly when the washing machine is not in use.
- Occasionally run a wash using the **Cottons 60 °C** programme with washing powder.

### Machine housing/control panel

- Wipe the housing and the control panel with a soft, damp cloth.
- Remove the detergent residue immediately.
- Do not clean with a water jet.

### Drum

Use chlorine-free cleaning agents, do not use steel wool.

If there are odours in the washing machine, or to clean the drum, run the **Drum Clean** programme\*\* or **Cottons 90 °C** programme without laundry. Add washing powder.

\* depending on the model

\*\* depending on the model

## Descaling

Descaling should not be necessary if the detergent is measured out correctly. However, if it is required, follow the manufacturer's instructions for the descaling agent. Suitable descalers can be obtained via our website or from our after-sales service. → Page 42

## Detergent drawer and housing

After the washing cycle, detergent or fabric softener residues may remain in the detergent drawer or on its housing.

To remove residues:

1. Pull out the detergent drawer. Press down the insert and fully remove the drawer.

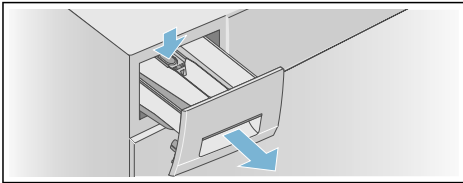

2. Remove the insert.
  - a) Push the insert upwards from below with your finger.

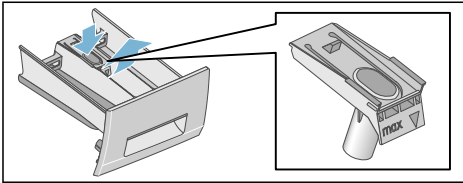

- b) If the measuring aid\* for liquid detergent is used, pull it upwards.

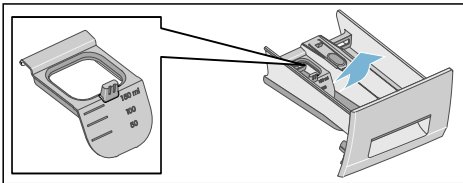

\* depending on the model

3. Clean the detergent drawer and insert with water and a brush, and dry it. Clean the inside of the housing as well.

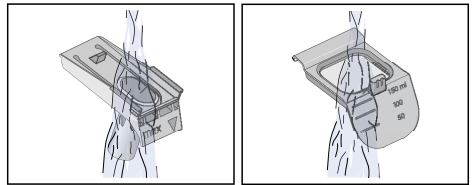
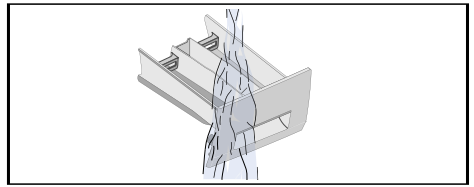

4. Fit the insert and lock it into place.
  - a) Push the cylinder onto the guide pin.

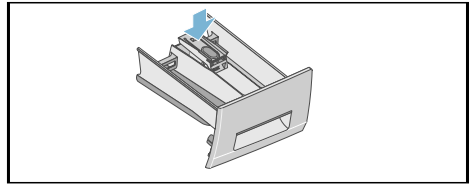

- b) If the measuring aid\* for liquid detergent is used, slide it forwards, fold down and click into place.

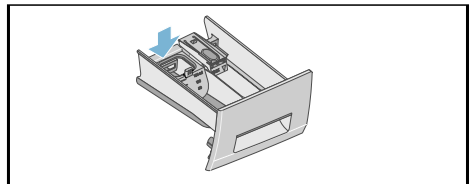

5. Push in the detergent drawer.

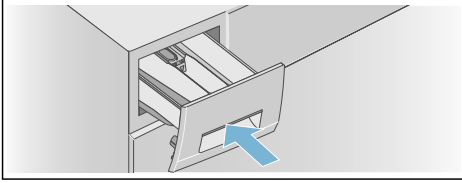

**Note:** Leave the detergent drawer open so that any residual water can evaporate.

## Drain pump is blocked

### **Warning** **Risk of scalding!**

When you wash at high temperatures, the water gets very hot. If you come into contact with the hot water, you may be scalded.  
Allow the water to cool down.

#### **After the water has cooled down:**

1. Turn off the water tap so that no more water can flow in and has to be drained via the drain pump.
2. Switch off the appliance. Disconnect the mains plug.
3. Open and remove the service flap.

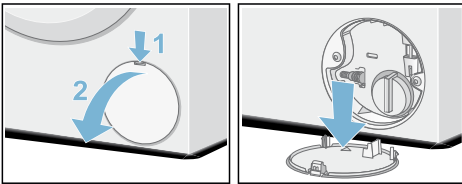

4. Take the drain hose out of the retainer.  
Remove the sealing cap and allow the water to flow out into a suitable container.  
Replace the sealing cap and place the drain hose in the retainer.

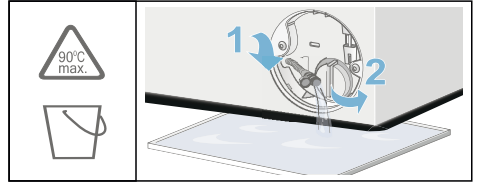

5. Carefully unscrew the pump cover; residual water may leak out.  
Clean the interior, pump cover thread and pump housing. The impeller in the drain pump must be able to rotate.  
Refit the pump cover and screw it on tightly. The handle must be in a vertical position.

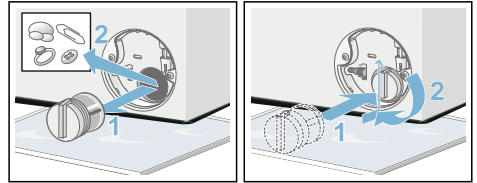

6. Place the service flap back on, lock it into place, and close it.

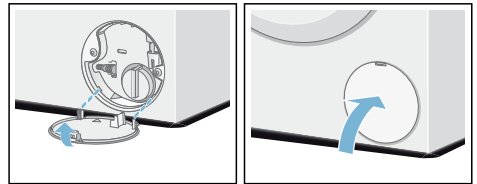

**Note:** To prevent unused detergent from flowing straight into the drain during the next wash, pour 1 litre of water (without detergent) into compartment II and start the **Drain/Empty** programme. Do the next wash as usual.

## Drain hose at the siphon is blocked

1. Switch off the appliance. Disconnect the mains plug.
2. Loosen the hose clamp. Carefully remove the drain hose; residual water may leak out.
3. Clean the drain hose and siphon connecting piece.

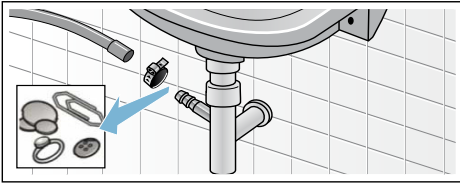

4. Reattach the drain hose and secure the connection using the hose clamp.

## Filter in the water supply is blocked



### **Warning** **Risk of electric shock!**

The Aqua-Stop contains an electric valve. There is a risk of electric shock if you immerse the Aqua-Stop safety valve in water. Do not immerse the safety valve in water.

First, reduce the water pressure in the supply hose:

1. Turn off the tap.
2. Select any programme (except Rinse/Spin/Drain/Empty).
3. Press the Start Reload  button. Allow the programme to run for approximately 40 seconds.
4. Turn the programme selector to the off position. Disconnect the mains plug.

5. Clean the filter on the tap:  
Disconnect the hose from the tap.  
Clean the filter with a small brush.

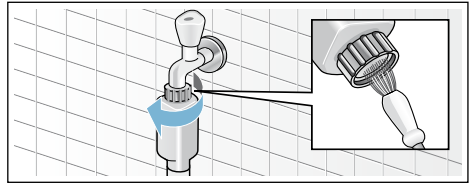

6. For standard and Aqua-Secure models, clean the filter on the rear of the appliance:  
Remove the hose from the rear of the appliance.  
Use pliers to remove the filter and then clean it.

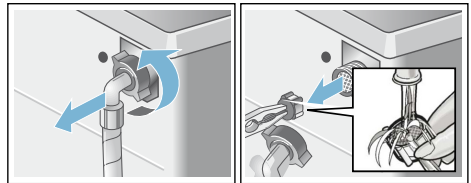

7. Insert the filter, connect the hose and check for leaks.

## Faults and what to do about them

### Emergency release

e.g. in the event of a power outage

**Note:** The programme will continue running when the power supply has been restored.

#### **Warning** **Risk of scalding!**

When you are washing at high temperatures, there is a risk of scalding if you come into contact with detergent solution and laundry.

If possible, leave it to cool down.

#### **Warning** **Risk of injury!**

You may injure your hands if you reach into the drum while it is turning.

Do not reach into the drum when it is turning. Wait until the drum has stopped turning.

#### **Caution!** **Water damage**





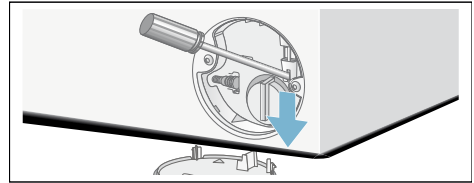

Any escaping water may cause water damage. Do not open the washing machine door if water can be seen through the glass.

**If the laundry has to be removed, the washing machine door can be opened as follows:**





1. Switch off the appliance. Disconnect the mains plug.
2. Drain the water.
3. Pull the emergency release downwards with a tool and release. The washing machine door can now be opened.







## Information on the display panel

Indicator/symbol	Cause/remedy
 has lit up	<ul style="list-style-type: none"> <li>■ The temperature is too high. Wait until the temperature drops.</li> <li>■ The water level is too high. It is not possible to add more laundry. Close the door immediately, if necessary. Press the Start Reload  button to resume the program.</li> </ul>
 is flashing	<ul style="list-style-type: none"> <li>■ Laundry may be trapped. Open and close the door again and press the Start Reload  button.</li> <li>■ If necessary, push the door closed or remove the trapped laundry and then push it closed again.</li> <li>■ If necessary, switch the appliance off and then on again; set a program and apply the settings you require; start the program.</li> </ul>
 has lit up	<ul style="list-style-type: none"> <li>■ Turn on the cold water tap fully;</li> <li>■ The supply hose is kinked/trapped;</li> <li>■ The water pressure is too low. Clean the filter. → <i>Page 37</i></li> </ul>
<i>E: 18</i>	<ul style="list-style-type: none"> <li>■ The drain pump is blocked. Clean the drain pump. → <i>Page 36</i></li> <li>■ The drain hose/drain pipe is blocked. Clean the drain hose at the siphon. → <i>Page 37</i></li> </ul>
<i>E: 23</i>	There is water in the base trough; the appliance is leaking. Turn off the tap. Call our after-sales service. → <i>Page 42</i>
<i>E: 32</i>	<p>is flashing alternately with <i>End</i> at the end of the program.</p> <p>Not a fault – the unbalanced load detection system has interrupted the spin cycle because the laundry is unevenly distributed.</p> <p>Distribute small and large items of laundry evenly in the drum. Run the spin cycle again, if necessary.</p>
	The childproof lock is active – deactivate it. → <i>Page 31</i>
The  indicator light for the Drum Clean program* is flashing	<p>Run the <b>Drum Clean*</b> program or a <b>60 °C</b> program to clean and care for the drum and the outer tub.</p> <p><b>Notes</b></p> <ul style="list-style-type: none"> <li>■ Run the program without laundry.</li> <li>■ Use standard washing powder or a detergent that contains a bleaching agent. To prevent foaming, only use half the amount of detergent recommended by the detergent manufacturer. Do not use detergents intended for woollens or delicates.</li> <li>■ Switch the notification signal on/off → <i>Page 33</i></li> </ul>
Other indicators and symbols	Switch off the appliance, wait for 5 seconds and then switch it back on. If the indicator/symbol appears again, call our after-sales service. → <i>Page 42</i>
* Depending on the model	

## Faults and what to do about them

Faults	Cause/remedy
Water is leaking from the appliance.	<ul style="list-style-type: none"> <li>■ Attach the drain hose correctly or replace it.</li> <li>■ Tighten the threaded joint on the supply hose.</li> </ul>
The appliance is not filling with water.	<ul style="list-style-type: none"> <li>■ Have you pressed the Start Reload  button?</li> <li>■ Is the tap turned on?</li> </ul>
Detergent is not being dispensed.	<ul style="list-style-type: none"> <li>■ Could the filter be clogged? Clean the filter. → Page 37</li> <li>■ Is the supply hose kinked or trapped?</li> </ul>
The door will not open.	<ul style="list-style-type: none"> <li>■ The safety function is active. <b>Note:</b> For safety reasons, the washing machine door remains locked when the water level or temperature is high (see → "Cancelling the programme" on page 31) or while the drum is rotating.</li> <li>■ Is the childproof lock  active? If so, deactivate it. → Page 31</li> <li>■ Is - - (Rinse Stop = no final spin) selected? → Page 32</li> <li>■ Can the door only be opened by the emergency release? → Page 38</li> </ul>
The program will not start.	<ul style="list-style-type: none"> <li>■ Have you pressed the Start Reload  button? → Page 30</li> <li>■ Is <b>Ready in</b> selected?</li> <li>■ Is the door closed?</li> <li>■ Is the childproof lock  active? If so, deactivate it. → Page 31</li> </ul>
The drum briefly jerks or judders after the program has started.	Not a fault – the internal motor test may cause the drum to jerk or judder briefly when the wash program starts.
The washing water is not being pumped away.	<ul style="list-style-type: none"> <li>■ Is - - (Rinse Stop = no final spin) selected? → Page 32</li> <li>■ Clean the drain pump. → Page 36</li> <li>■ Clean the drain pipe and/or the drain hose. → Page 37</li> </ul>
Water is not visible in the drum.	Not a fault – the water is below the visible area.
The spin result is not satisfactory. Laundry wet/too damp.	<ul style="list-style-type: none"> <li>■ Not a fault – the unbalanced load detection system has interrupted the spin cycle because the laundry is unevenly distributed. Distribute small and large items of laundry evenly in the drum.</li> <li>■ Is <b>Easy-Iron*</b> selected? → Page 28</li> <li>■ Is the selected speed too low?</li> </ul>
The machine spins the drum back and forth several times.	Not a fault – the unbalanced load detection system is eliminating an imbalance.
The program is taking longer than usual.	<ul style="list-style-type: none"> <li>■ Not a fault – the unbalanced load detection system is eliminating an imbalance by repeatedly redistributing the laundry.</li> <li>■ Not a fault – the foam detection system is active; this adds an additional rinse cycle.</li> </ul>
The length of the program changes during the wash cycle.	Not a fault – the program sequence is optimised for the specific washing process. This may change the program duration shown on the display panel.
* Depending on the model	



Faults	Cause/remedy
Water remaining in the care product compartment  .	<ul style="list-style-type: none"> <li>■ Not a fault – the effectiveness of the care product is not affected.</li> <li>■ Clean the insert if necessary.</li> </ul>
Odours or a greasy film in the washing machine.	<p>Depending on the model, run the <b>Drum Clean*</b> or <b>Cottons 90 °C</b> program without laundry.</p> <p>Add standard washing powder or a detergent that contains a bleaching agent.</p> <p><b>Note:</b> To prevent foaming, only use half the amount of detergent recommended by the detergent manufacturer. Do not use detergents intended for woollens or delicates.</p>
Foam is leaking from the detergent drawer.	<p>Have you used too much detergent?</p> <p>Mix one tablespoon of fabric softener with 1/2 litre of water and pour it into compartment <b>II</b>. This solution is not suitable for outdoor clothing, sportswear or items stuffed with down.</p> <p><b>Note:</b> To prevent the machine from producing too much foam, the next time you run a wash cycle, add less detergent for the same size load.</p>
Loud noises, vibrations and machine "wandering" during the spin and/or drain cycles.	<p>The amount of noise generated during pumping is not the same as during washing.</p> <ul style="list-style-type: none"> <li>■ Is the appliance level? Level the appliance. → <i>Page 17</i></li> <li>■ Are the appliance's feet secured? Secure the appliance's feet. → <i>Page 17</i></li> <li>■ Have the transit bolts been removed? Remove the transit bolts. → <i>Page 14</i></li> </ul>
The display panel/indicator lights do not work while the appliance is running.	<ul style="list-style-type: none"> <li>■ Has there been a power failure?</li> <li>■ Have the fuses blown/has the circuit breaker tripped? Reset/replace the circuit breaker/fuses.</li> <li>■ If the fault occurs repeatedly, call our after-sales service. → <i>Page 42</i></li> </ul>
There is detergent residue on the laundry.	<ul style="list-style-type: none"> <li>■ Some phosphate-free detergents contain water-insoluble residue.</li> <li>■ Select <b>Rinse</b> or brush the laundry after washing.</li> </ul>
The  symbol is lit on the display panel when the program is paused.	<ul style="list-style-type: none"> <li>■ The water level is too high. It is not possible to add more laundry. Close the door immediately if necessary.</li> <li>■ Press the Start Reload  button to resume the program.</li> </ul>
The  symbol is not lit on the display when the program is paused.	<p>The door is unlocked. It is possible to add laundry.</p>
<p>If you cannot rectify a fault yourself (after switching the machine off and then on again) or a repair is required:</p> <ul style="list-style-type: none"> <li>■ Switch off the appliance and pull out the mains plug.</li> <li>■ Turn off the tap and call the after-sales service. → <i>Page 42</i></li> </ul>	
<p>* Depending on the model</p>	



## After-sales service

If you cannot rectify a fault yourself, please contact our after-sales service.

We will always find an appropriate solution to avoid unnecessary visits by engineers.

Please provide the after-sales service with the product number (E no.) and the production number (FD) of the appliance.

E-Nr. _____	FD _____
-------------	----------

E no.      Product number  
FD        Production number

You can find this information (depending on the model):

- On the inside of the loading door or the service flap
- On the back of the appliance

**Trust the expertise of the manufacturer.** Contact us. By doing so, you can be sure that the repairs are carried out by trained service personnel using genuine spare parts.



## Technical data

### Dimensions:

850 x 600 x 550 mm  
(Height x width x depth)

### Weight

63-83 kg (depending on model)

### Mains connection:

Mains voltage 220-240 V, 50 Hz

Nominal current 10 A

Nominal output 2300 W

### Water pressure:

100-1000 kPa (1-10 bar)

### Power consumption when switched off:

0.12 W

### Power consumption when ready for use (left-on mode):

0.50 W



## Aqua-Stop warranty

### Only for appliances with Aqua-Stop

In addition to warranty claims against the vendor based on the purchase agreement and to our appliance warranty, we will provide compensation under the following conditions:

1. If water damage is caused due to a fault in our Aqua-Stop system, we will compensate domestic customers for the damage caused.
2. The liability guarantee is valid for the service life of the appliance.
3. It is a prerequisite of all warranty claims that the appliance with Aqua-Stop must have been installed and connected correctly in accordance with our instructions; this also includes a correctly fitted Aqua-Stop extension (genuine accessories). Our warranty does not cover defective feed lines or fittings leading to the Aqua-Stop connection at the tap.
4. Appliances with Aqua-Stop do not need to be supervised during operation, nor secured afterwards by turning off the tap.  
The tap only needs to be turned off if you are away from home for a long period, e.g. for several weeks' holiday.



### **Advice and repair order in the event of faults**

GB 0344 892 8979 (Calls charged at local or mobile rate.)

IE 01450 2655 (0.03 € per minute at peak. Off peak 0.0088 € per minute.)

You can find the contact information for all countries in the attached after-sales service directory.

Robert Bosch Hausgeräte GmbH  
Carl-Wery-Straße 34  
81739 München, GERMANY



9001327820 (9804)