

USER MANUAL

SAFETY INSTRUCTIONS

Before using the appliance, read these safety instructions. Keep them nearby for future reference.

These instructions and the appliance itself provide important safety warnings, to be observed at all times. The manufacturer declines any liability for failure to observe these safety instructions, for inappropriate use of the appliance or incorrect setting of controls.

⚠ Very young children (0-3 years) should be kept away from the appliance. Young children (3-8 years) should be kept away from the appliance unless continuously supervised. Children from 8 years old and above and persons with reduced physical, sensory or mental capabilities or lack of experience and knowledge can use this appliance only if they are supervised or have been given instructions on safe use and understand the hazards involved. Children must not play with the appliance. Cleaning and user maintenance must not be carried out by children without supervision.

⚠ **WARNING:** The appliance and its accessible parts become hot during use. Care should be taken to avoid touching heating elements. Children less than 8 years of age must be kept away unless continuously supervised.

⚠ Never leave the appliance unattended during food drying. If the appliance is suitable for probe usage, only use a temperature probe recommended for this oven - risk of fire.

⚠ Keep clothes or other flammable materials away from the appliance, until all the components have cooled down completely - risk of fire. Always be vigilant when cooking foods rich in fat, oil or when adding alcoholic beverages - risk of fire. Use oven gloves to remove pans and accessories. At the end of cooking, open the door with caution, allowing hot air or steam to escape gradually before accessing the cavity - risk of burns. Do not obstruct hot air vents at the front of the oven - risk of fire.

⚠ Exercise caution when the oven door is in the open or down position, to avoid hitting the door.

PERMITTED USE

⚠ **CAUTION:** The appliance is not intended to be operated by means of an external switching device, such as a timer, or separate remote controlled system.

⚠ This appliance is intended to be used in household and similar applications such as: staff kitchen areas in shops, offices and other working environments; farm houses; by clients in hotels, motels, bed & breakfast and other residential environments.

⚠ No other use is permitted (e.g. heating rooms).

IMPORTANT TO BE READ AND OBSERVED

⚠ This appliance is not for professional use. Do not use the appliance outdoors.

⚠ Do not store explosive or flammable substances (e.g. gasoline or aerosol cans) inside or near the appliance - risk of fire.

INSTALLATION

⚠ The appliance must be handled and installed by two or more persons - risk of injury. Use protective gloves to unpack and install - risk of cuts.

⚠ Installation, including water supply (if any) and electrical connections, and repairs must be carried out by a qualified technician. Do not repair or replace any part of the appliance unless specifically stated in the user manual. Keep children away from the installation site. After unpacking the appliance, make sure that it has not been damaged during transport. In the event of problems, contact the dealer or your nearest After-sales Service. Once installed, packaging waste (plastic, styrofoam parts etc.) must be stored out of reach of children - risk of suffocation. The appliance must be disconnected from the power supply before any installation operation - risk of electrical shock. During installation, make sure the appliance does not damage the power cable - risk of fire or electrical shock. Only activate the appliance when the installation has been completed.

⚠ Carry out all cabinet cutting works before fitting the appliance in the furniture and remove all wood chips and sawdust. Do not obstruct the minimum gap between the worktop and the upper edge of the oven - risk of burns.

Do not remove the oven from its polystyrene foam base until the time of installation.

⚠ After installation, the bottom of the appliance must no longer be accessible - risk of burn.

⚠ Do not install the appliance behind a decorative door - risk of fire.

ELECTRICAL WARNINGS

⚠ The rating plate is on the front edge of the oven (visible when the door is open).

⚠ It must be possible to disconnect the appliance from the power supply by unplugging it if plug is accessible, or by a multi-pole switch installed upstream of the socket in accordance with the wiring rules and the appliance must be earthed in conformity with national electrical safety standards.

⚠ Do not use extension leads, multiple sockets or adapters. The electrical components must not be accessible to the user after installation. Do not use the appliance when you are wet or barefoot. Do not operate this appliance if it has a damaged power cable or plug, if it is not working properly, or if it has been damaged or dropped.

⚠ If the supply cord is damaged, it must be replaced with an identical one by the manufacturer, its service agent or similarly qualified persons in order to avoid a hazard - risk of electrical shock.

⚠ In case of replacement of power cable, contact an authorized service center.

CLEANING AND MAINTENANCE

⚠ **WARNING:** Ensure that the appliance is switched off and disconnected from the power supply before performing any maintenance operation; never use steam cleaning equipment - risk of electric shock.

⚠ Do not use harsh abrasive cleaners or metal scrapers to clean the door glass since they can scratch the surface, which may result in shattering of the glass.

⚠ Ensure the appliance is cooled down before any cleaning or maintenance. - risk of burn.

⚠ **WARNING:** Switch off the appliance before replacing the lamp - risk of electrical shock.

DISPOSAL OF PACKAGING MATERIALS

The packaging material is 100% recyclable and is marked with the recycle symbol . The various parts of the packaging must therefore be disposed of responsibly and in full compliance with local authority regulations governing waste disposal.

DISPOSAL OF HOUSEHOLD APPLIANCES

This appliance is manufactured with recyclable or reusable materials. Dispose of it in accordance with local waste disposal regulations. For further information on the treatment, recovery and recycling of household electrical appliances, contact your local authority, the collection service for household waste or the store where you purchased the appliance. This appliance is marked in compliance with European Directive 2012/19/EU, Waste Electrical and Electronic Equipment (WEEE). By ensuring this product is disposed of correctly, you will help prevent negative consequences for the environment and human health.

The  symbol on the product or on the accompanying documentation indicates that it should not be treated as domestic waste but must be taken to an appropriate collection center for the recycling of electrical and electronic equipment.

ENERGY SAVING TIPS

Only preheat the oven if specified in the cooking table or your recipe. Use dark lacquered or enameled baking trays as they absorb heat better. Food requiring prolonged cooking will continue to cook even once the oven is switched off.

ECO DESIGN DECLARATION

This appliance meets the Eco Design requirements of European Regulations n.65/2014 and 66/2014 in conformity to the European standard EN 60350-1.

PRODUCT DESCRIPTION

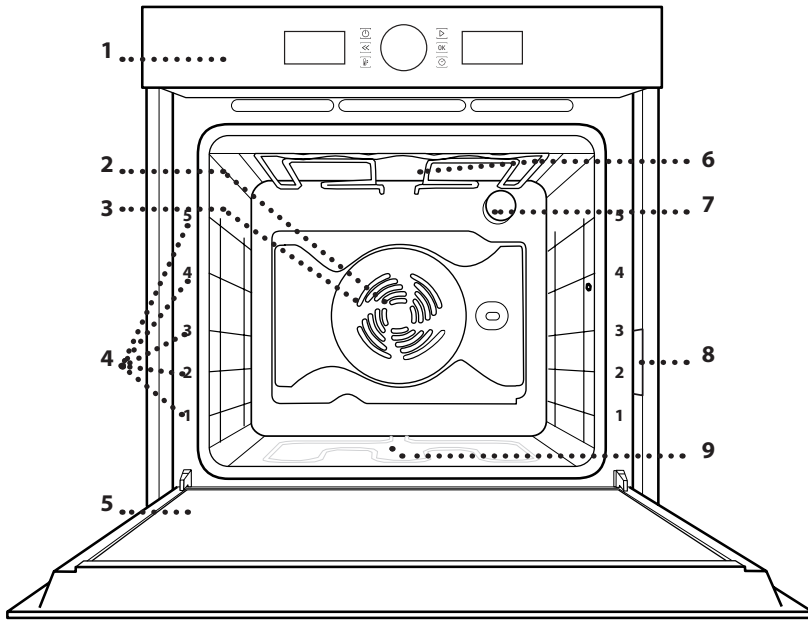

1. Control panel
2. Fan
3. Circular heating element
(non-visible)
4. Shelf guides
(the level is indicated on the front
of the oven)
5. Door
6. Upper heating element/grill
7. Lamp
8. Identification plate
(do not remove)
9. Bottom heating element
(non-visible)

Please note:

The cooling fan may switch itself on every so often during cooking in order to reduce energy consumption.

Once cooking is complete and the oven has been switched off, the cooling fan may continue to run for a certain period of time.

When the oven door is opened during cooking, the heating elements switch off.

CONTROL PANEL

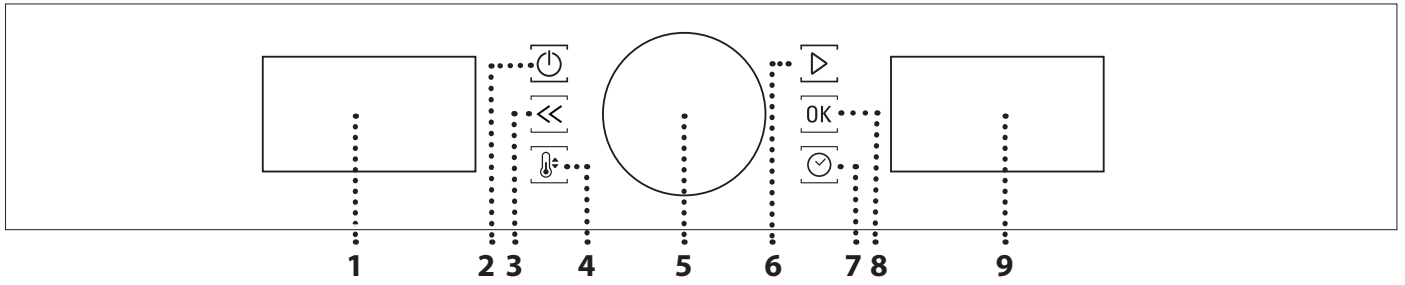

1. LEFT-HAND DISPLAY

2. ON / OFF

For switching the oven on and off and for stopping an active function at any time.

3. BACK

For returning to the previous menu when configuring settings.

4. TEMPERATURE

For setting the temperature.

5. KNOB

For selecting menu items and changing or adjusting the settings of a function.

6. START

For starting functions and confirming settings.

7. TIME

For setting or changing the time and adjusting the cooking time.

8. CONFIRM

For confirming an item you have selected or the settings for a function.

9. RIGHT-HAND DISPLAY

DESCRIPTION OF DISPLAYS

LEFT HAND DISPLAY

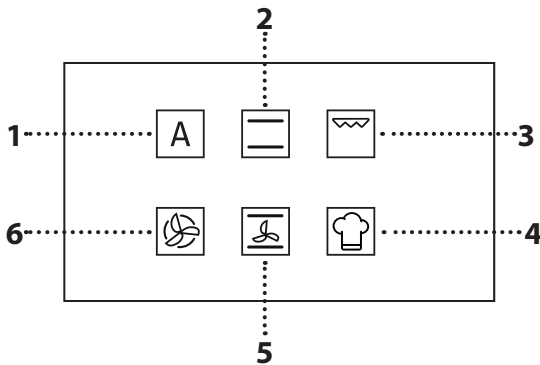

1. Automatic functions
2. Conventional function
3. Grill function
4. Special functions
5. Convection bake function
6. Forced air function

RIGHT HAND DISPLAY

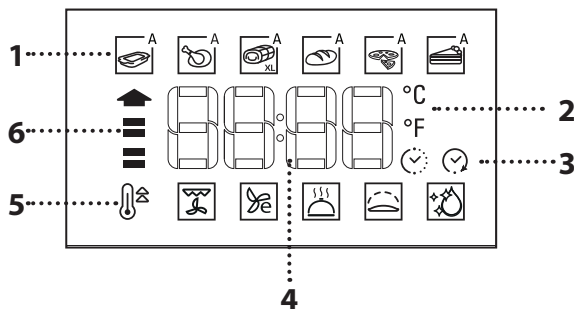

1. Automatic functions cluster
2. Unit of measurement temperature
3. Time options (duration, start delay)
4. Digital display (shows, for example: the clock, all function values or settings)
5. Special functions cluster
6. Preheating phase indication

ACCESSORIES

WIRE SHELF

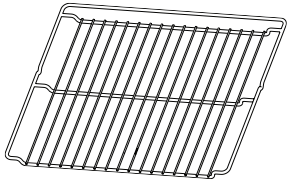

For use in cooking food or as a support for pans, baking pans and other ovenproof cooking receptacles.

DRIP TRAY

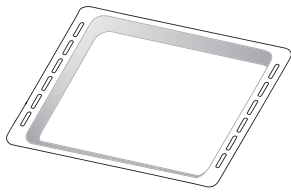

For use as an oven tray for cooking meat, fish, vegetables, focaccia, etc. or to collect cooking juices when positioned under the wire shelf.

BAKING TRAY

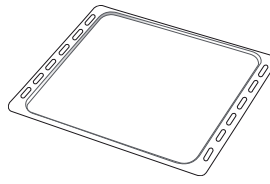

For use in cooking bread and pastry products, but also for meat, fish en papillote, etc.

SLIDING RUNNERS *

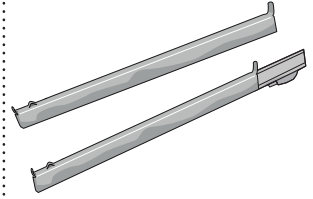

To facilitate inserting or removing accessories.

TURNSPIT *

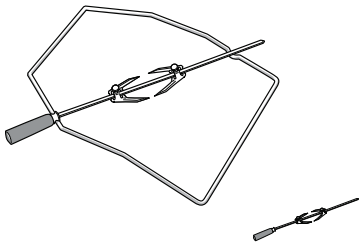

For roasting large pieces of meat and poultry uniformly in conjunction with the "Turbo grill" function.

GRILL PAN SET *

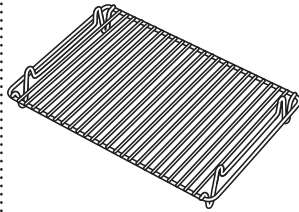

To be placed inside the drip tray, creating a useful set for grilling meat, fish or vegetables.

*Available only on certain models.

The number of accessories may vary depending on which model is purchased.

Other accessories that are not supplied can be purchased separately from the After-Sales Service.

INSERTING THE WIRE SHELF AND OTHER ACCESSORIES

1. Insert the wire shelf horizontally by sliding it across the shelf guides, making sure that the side with the raised edge is facing upwards.

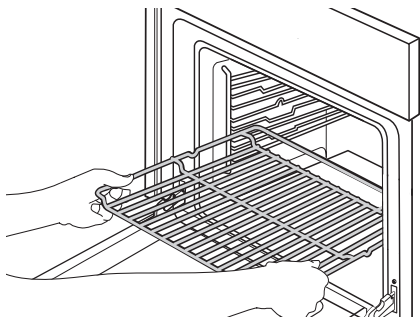

2. Other accessories, such as the drip tray and the baking tray, are inserted horizontally in the same way as the wire shelf.

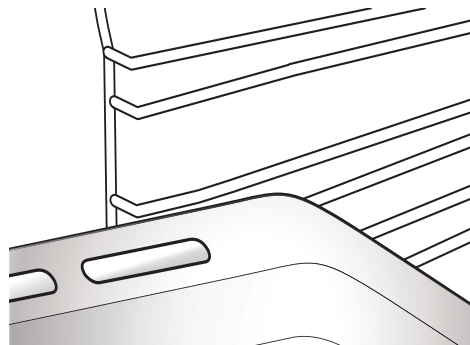

USING THE TURNSPIT (IF PRESENT)

1. Insert the skewer into the centre of the meat and slide it in until it is held firmly in place on the fork.

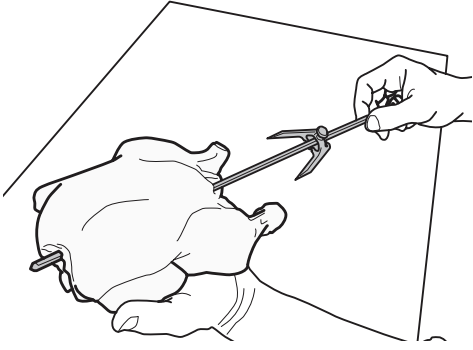

2. Push the second fork onto the skewer and slide it on until it holds the meat firmly in place.

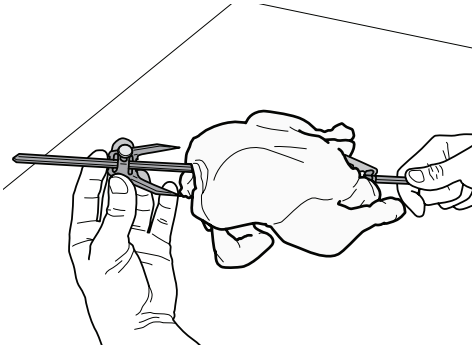

3. Tighten the fixing screw to secure it in position.

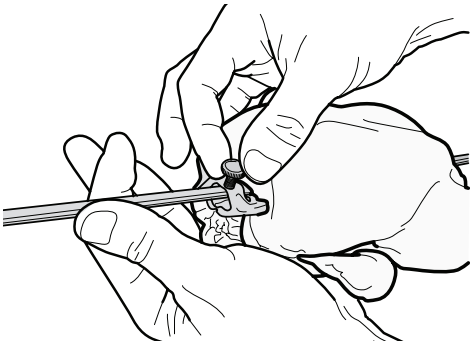

4. If cooking poultry, be sure to secure the meat with twine.

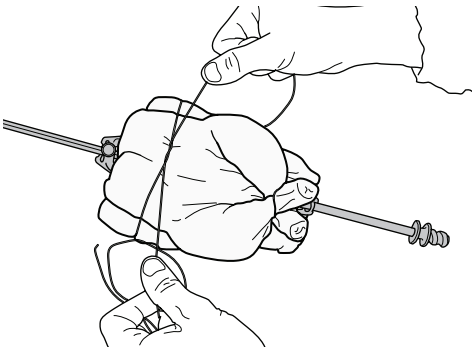

5. Insert the support at the second level, then insert the tip of the skewer in the seating located on the rear wall of the oven compartment.

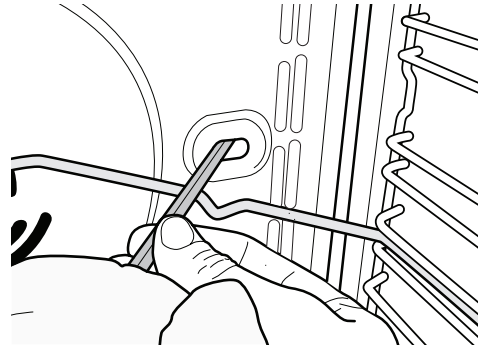

6. Rest the round part of the skewer on the relevant support.

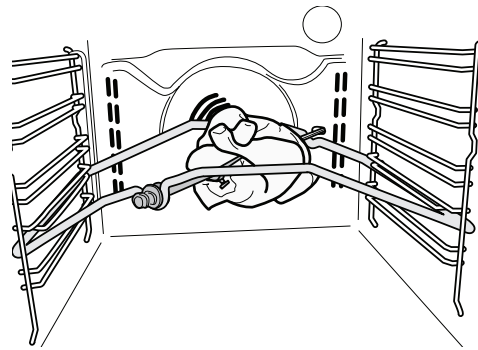

To use the turnspit, select the "Turbo grill" function. To collect the cooking juices, position the drip tray below the meat and add 500 ml of water.

To avoid burning yourself, manipulate the hot skewer with the plastic handle (which must be removed before cooking).

REMOVING AND REFITTING THE SHELF GUIDES

1. To remove the shelf guides, lift the guides up (1) and then gently pull the lower part out of its seating (2): the shelf guides can now be removed.

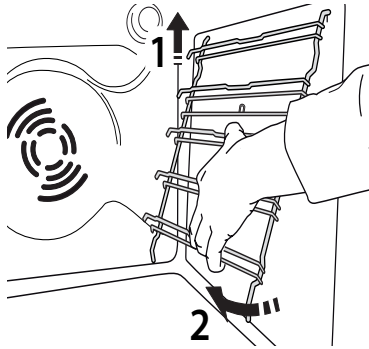

2. To refit the shelf guides, first fit them back into their upper seating.

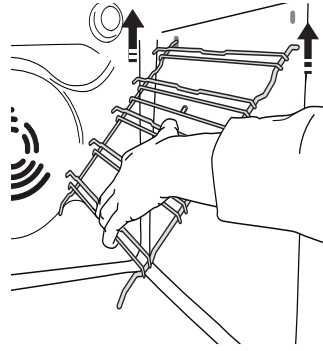

3. Keep them raised as you bring them nearer to the compartment.

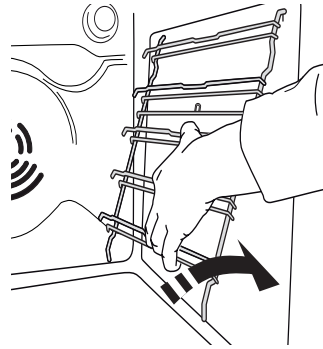

4. Position them into the lower seatings.

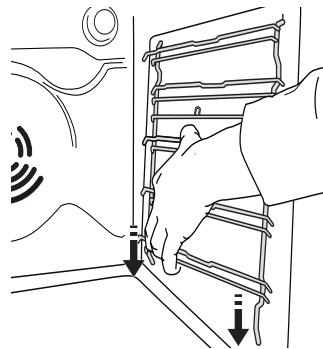

FITTING THE SLIDING RUNNERS (ONLY IN SOME MODELS)

1. Remove the shelf guides.
2. Remove the plastic protection from the sliding runners.

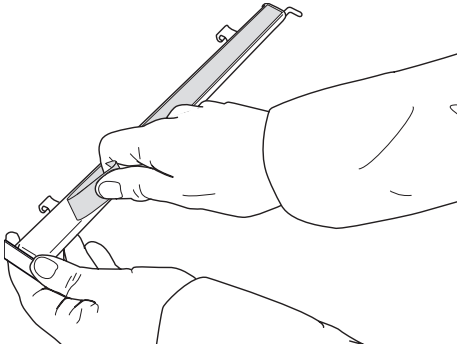

3. Fasten the upper clip of the runner to the shelf guide and slide it along as far as it will go. (fig. A); lower the other clip into position.

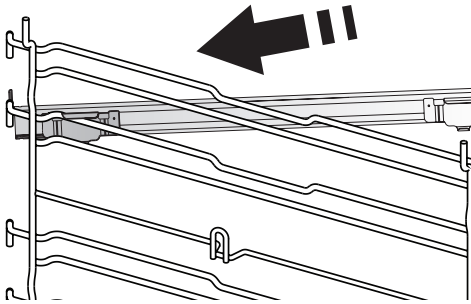

4. To secure the guide, press the lower portion of the clip firmly against the shelf guide. Make sure that the runners can move freely.

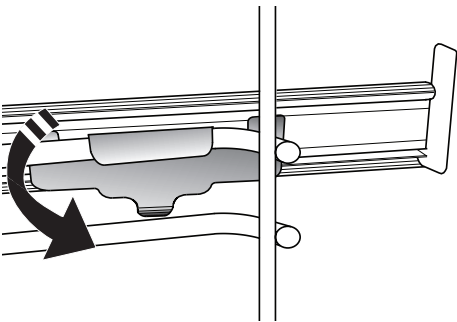

5. Repeat these steps on the other shelf guide on the same level. The sliding runners can be fitted on any level.

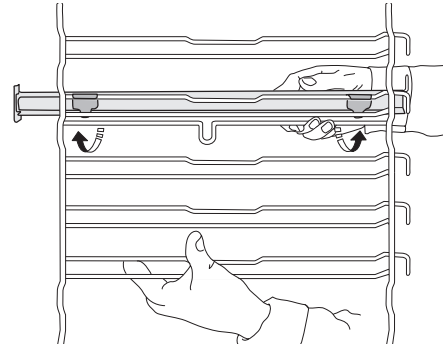

6. Refit the shelf guides.

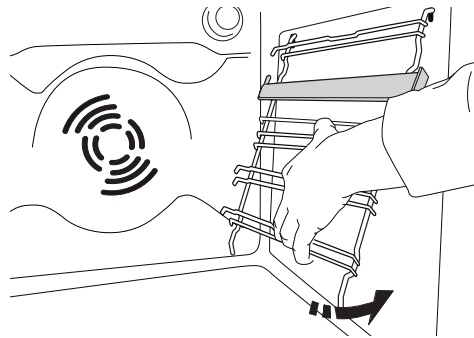

7. Position the accessories on the shelf guides.

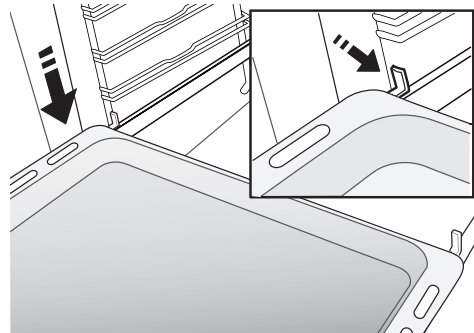

FUNCTIONS

AUTOMATIC FUNCTIONS

A CASSEROLE

The function automatically selects the best cooking mode and temperature for baking any preparation based on pasta (lasagna, cannelloni, ecc). The temperature may be modified in a given range to perfectly fit different recipes and personal tastes. Use the 3rd shelf. The oven doesn't have to be preheated.

A MEAT

The function automatically selects the best cooking mode and temperature for roasting any type of meat (poultry, beef, veal, pork, lamb, ecc). The temperature may be modified in a given range to perfectly fit different recipes and personal tastes. This function uses discontinuous, delicate fan assistance, which prevents excessive drying of foods. Use the 3rd shelf. The oven doesn't have to be preheated before cooking.

A MAXI COOKING

The function automatically selects the best cooking mode and temperature to cook large joints of meat (above 2.5 kg). It is advisable to turn the meat over during cooking for more even browning. It is best to baste the meat every now and again to prevent it from drying out. Use the 1st or 2nd shelves, depending on the size of the joint. The oven doesn't have to be preheated before cooking.

A BREAD

The function automatically selects the best cooking mode and temperature for baking any type of bread (baguettes, small breads, sandwich loaf, ecc). The temperature may be modified in a given range to perfectly fit different recipes and personal tastes. Use the 2nd or 3rd shelf. The oven doesn't have to be preheated.

A PIZZA

The function automatically selects the best cooking mode and temperature for baking any type of pizza (thin pizza, homestyle pizza, focaccia, ecc). The temperature may be modified in a given range to perfectly fit different recipes and personal tastes. Use the 2nd shelf. The oven doesn't have to be preheated.

A PASTRY CAKES

The function automatically selects the best cooking mode and temperature for baking any sweet preparation (biscuits, leavened cakes, fruit tarts, ecc). The temperature may be modified in a given range to perfectly fit different recipes and personal tastes. Use the 2nd or 3rd shelf. The oven does not have to be preheated.

CONVENTIONAL

For cooking any kind of dish on one shelf only. Use the 3rd shelf. To cook pizza, savoury pies and sweets with liquid fillings, use the 1st or 2nd shelf. Preheat the oven before placing food inside.

GRILL

For grilling steaks, kebabs and sausages, cooking vegetables au gratin or toasting bread. It is advisable to place food on the 4th or 5th shelf. When grilling meat, we recommend using a drip tray to collect the cooking juices: Position the tray on any of the levels below the wire shelf and add 500 ml of drinking water. The oven does not have to be preheated. During cooking the oven door must remain closed.

FORCED AIR

For cooking different foods that require the same cooking temperature on several shelves (maximum three) at the same time. This function can be used to cook different foods without odours being transferred from one food to another. Use the 3rd level to cook on one shelf only, 1st and 4th level to cook on two shelves, 1st, 3rd, 5th level to cook on three shelves. Wait the end of preheating before placing food inside the oven.

CONVECTION BAKE

For cooking meat and cakes with juicy fillings (savoury or sweet) on single shelf. Use the 3rd shelf. Preheat the oven before cooking.



SPECIAL FUNCTIONS



FAST PREHEATING

For preheating the oven quickly. To preheat the oven rapidly. At the end of preheating, the oven automatically selects the conventional function. Wait the end of preheating before placing food inside.



TURBO GRILL

For roasting large joints of meat (legs, roast beef, chicken). Position the food on the middle shelves. We recommend using a Baking tray to collect the cooking juices: position it on the 1st or 2nd level, adding approx. half a litre of water. The oven does not have to be preheated. During cooking, the oven door must remain closed.



ECO FORCED AIR*

For cooking stuffed roasting joints and fillets of meat on a single shelf. Food is prevented from drying out excessively by gentle, intermittent air circulation. When this ECO function is in use, the light will remain switched off during cooking. To use the ECO cycle and therefore optimise power consumption, the oven door should not be opened until the food is completely cooked.



KEEP WARM

For keeping just-cooked food hot and crisp (e.g: meat, fried food or flans). Place the food on the middle shelf.



RISING

For helping sweet or savoury dough to rise effectively. Place the dough on the 2nd shelf. The oven does not have to be preheated. To maintain the quality of proving, do not activate the function if the oven is still hot following a cooking cycle.



DIAMOND CLEAN

The action of the steam released during this special low-temperature cleaning cycle allows dirt and food residues to be removed with ease. Pour 200 ml of drinking water on the bottom of the oven and only activate the function when the oven is cold.

* Function used as reference for the energy efficiency declaration in accordance with Regulation (EU) No. 65/2014

USING THE APPLIANCE FOR THE FIRST TIME

1. SET THE TIME

You will need to set the time when you switch on the oven for the first time.



The two digits for the hour will start flashing: Turn the knob to set the hour and press **OK** to confirm.



The two digits for the minutes will start flashing. Turn the knob to set the minutes and press **OK** to confirm.

Please note: To change the time at a later point, press and hold **⏸** for at least one second while the oven is off and repeat the steps above.

You may need to set the time again following lengthy power outages.

2. HEAT THE OVEN

A new oven may release odours that have been left behind during manufacturing: this is completely normal.

Before starting to cook food, we therefore recommend heating the oven with it empty in order to remove any possible odours.

Remove any protective cardboard or transparent film from the oven and remove any accessories from inside it.



Heat the oven to 200 °C for around one hour, ideally using a function with air circulation (e.g. "Forced Air" or "Convection Bake").

Follow the instructions for setting the function correctly.

Please note: It is advisable to air the room after using the appliance for the first time.

DAILY USE

1. SELECT A FUNCTION

When the oven is off, only the time is shown on the display. Press and hold  to switch the oven on. Turn the knob to view the main functions available on the left-hand display. Select one and press .



To select a sub-function (where available), select the main function and then press  to confirm and go to the function menu.



Turn the knob to view the sub-functions available on the right-hand display. Select one and press  to confirm.

2. SET THE FUNCTION

After having selected the function you require, you can change its settings. The display will show the settings that can be changed in sequence.

TEMPERATURE/GRILL LEVEL



When the °C/°F icon flashes on the display, turn the knob to change the value, then press  to confirm and continue to alter the settings that follow (if possible).



You can also set the grill level (3 = high, 2 = medium, 1 = low) at the same time.



Please note: Once the function has started, you can change the temperature or the grill level by pressing  or by turning the knob directly.



DURATION



When the  icon flashes on the display, use the adjustment knob to set the cooking time you require and then press .

You do not have to set the cooking time if you want to manage cooking manually: Press  to confirm and start the function.

In this case, you cannot set the end cooking time by programming a delayed start.

Please note: You can adjust the cooking time that has been set during cooking by pressing : Turn the knob to change the hour and press .

SETTING THE END COOKING TIME/ DELAYED START

In many functions, once you have set a cooking time you can delay starting the function by programming its end time.

Where you can change the end time, the display will show the time the function is expected to finish while the  icon flashes.





If necessary, turn the knob to set the time you want cooking to end, then press  to confirm and start the function.

Place the food in the oven and close the door: The function will start automatically after the period of time that has been calculated in order for cooking to finish at the time you have set.



Please note: Programming a delayed cooking start time will disable the oven preheating phase. The oven will reach the temperature you require gradually, meaning that cooking times will be slightly longer than those listed in the cooking table.

During the waiting time, you can use the knob to change the programmed end time.

Press  or  to change the temperature and cooking time settings. Press  to confirm when finished.

3. ACTIVATE THE FUNCTION

Once you have applied the settings you require, press  to activate the function.

You can press and hold  at any time to pause the function that is currently active.

4. PREHEATING

Some functions have an oven preheating phase: Once the function has started, the display indicates that the preheating phase has been activated.



Once this phase has finished, an audible signal will sound and the display will indicate that the oven has reached the set temperature.



At this point, open the door, place the food in the oven, close the door and start cooking by pressing .

Please note: Placing the food in the oven before preheating has finished may have an adverse effect on the final cooking result.

Opening the door during the preheating phase will pause it.

The cooking time does not include a preheating phase.

You can always change the temperature you want to reach using the knob.

5. END OF COOKING

An audible signal will sound and the display will indicate that cooking is complete.



To extend the cooking time without changing the settings, turn the knob to set a new cooking time and press .

. AUTOMATIC FUNCTIONS

TEMPERATURE RECOVERY

If the temperature inside the oven decreases during a cooking cycle because the door is opened, a special function will be activated automatically to restore the original temperature.

While the temperature is being restored, the display will show a "snake" animation until the set temperature has been reached.

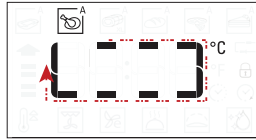

While a programmed cooking cycle is in progress, the cooking time will be increased according to how long the door was open in order to guarantee best results.

. SPECIAL FUNCTIONS

DIAMOND CLEAN

To activate the "Diamond Clean" function, with the oven cold, distribute 200 ml of water on the bottom of the oven cavity, then close the oven door.

Access special functions  and turn the knob to select  from menu. then press  to confirm.

Press  to start immediately the cleaning cycle, or press  to set the end time/start delayed.

At the end of the cycle, let the oven cooling down and remove any residual water in the oven and start cleaning using a sponge moistened with hot water (cleaning could be compromised if delayed by more than 15 minutes).

Please note: The duration and temperature of cleaning cycle cannot be set.

. KEY LOCK

To lock the keypad, press and hold  for at least 5 seconds.



Do this again to unlock the keypad.

Please note: The key lock can also be activated while cooking is in progress.

For safety reasons, the oven can be switched off at any time by pressing .

USEFUL TIPS

HOW TO READ THE COOKING TABLE

The table lists the best function, accessories and level to use to cook various different types of food. Cooking times start from the moment food is placed in the oven, excluding preheating (where required).

Cooking temperatures and times are approximate and depend on the amount of food and the type of accessory used.

Use the lowest recommended settings to begin with and, if the food is not cooked enough, then switch to higher settings.

Use the accessories supplied and preferably dark-coloured metal cake tins and baking trays. You can also use Pyrex or stoneware pans and accessories, but bear in mind that cooking times will be slightly longer.

COOKING DIFFERENT FOODS AT THE SAME TIME

The "Forced Air" function enables you to cook different foods (such as fish and vegetables) on different shelves at the same time.

Remove the food which requires a shorter cooking time and leave the food which requires a longer cooking time in the oven.

DESSERTS

Cook delicate desserts with the conventional function on one shelf only.

Use dark-coloured metal baking pans and always place them on the wire shelf supplied.

To cook on more than one shelf, select the "Forced Air" function and position the cake tins on different shelves to facilitate the circulation of hot air.

To check whether a leavened cake is fully cooked, insert a wooden toothpick into the centre of the cake. If the toothpick comes out clean, the cake is ready.

If using non-stick baking pans, do not butter the edges as the dessert may not rise evenly around the edges.

If the item "swells" during baking, use a lower temperature next time and consider reducing the amount of liquid you add or stirring the mixture more gently.

Desserts with moist fillings (cheesecake or fruit pies) require the use of the "Convection Bake" function.

If the base of the cake is soggy, lower the shelf and sprinkle the bottom of the cake with breadcrumbs or biscuit crumbs before adding the filling.

PIZZA

Lightly grease the trays to ensure the pizza has a crispy base.

Scatter the mozzarella over the pizza two thirds of the way through cooking.

PROVING

It is always best to cover the dough with a damp cloth before placing it in the oven.

Dough proving time with this function is reduced by approximately one third compared to proving at room temperature (20-25°C).

The rising time for pizza starts at around one hour for 1 kg of dough.

MEAT





























Use any kind of oven tray or pyrex dish suited to the size of the piece of meat being cooked.

For roast meat, it is best to add some stock to the bottom of the pan, basting the meat during cooking for added flavour. When the roast is ready, let it rest in the oven for another 10-15 minutes, or wrap it in aluminium foil.

When you want to grill meat, choose cuts with an even thickness all over in order to achieve uniform cooking results. Very thick pieces of meat require longer cooking times. To prevent the meat from burning on the outside, lower the position of the wire shelf, keeping the food farther away from the grill. Turn the meat two-thirds of the way through cooking.

To collect the cooking juices, place a drip tray with half a litre of water directly under the grill on which the meat is placed. Top-up when necessary.

COOKING TABLE

RECIPE	FUNCTION	PREHEAT.	TEMPERATURE (°C)	DURATION (Min.)	SHELF AND ACCESSORIES
Leavened cakes		—	160 - 180	30 - 90	2/3
		Yes	160 - 180	30 - 90	4 1
Filled cakes (cheesecake, strudel, apple pie)		—	160 - 200	30 - 85	3
		Yes	160 - 200	35 - 90	4 1
Biscuits / Tartlets		—	170 - 180	15 - 45	3
		Yes	160 - 170	20 - 45	4 1
		Yes	160 - 170	20 - 45 ***	5 3 1
Choux buns		—	180 - 200	30 - 40	3
		Yes	180 - 190	35 - 45	4 1
		Yes	180 - 190	35 - 45 ***	5 3 1
Meringues		Yes	90	110 - 150	3
		Yes	90	130 - 150	4 1
		Yes	90	140 - 160 ***	5 3 1
Pizza (Thin, thick, focaccia)		—	220 - 250	20 - 40	2
		Yes	220 - 240	20 - 40	4 1
		Yes	220 - 240	25 - 50 ***	5 3 1
Bread loaf 0.5 kg		—	180 - 220	50 - 70	2
Small bread		—	180 - 220	30 - 50	2
Bread		Yes	180 - 200	30 - 60	4 1
Frozen pizza		—	250	10 - 20	2
		Yes	250	10 - 20	4 1
Savoury pies (vegetable pie, quiche)		Yes	180 - 190	45 - 60	2
		Yes	180 - 190	45 - 60	4 1
		Yes	180 - 190	45 - 70 ***	5 3 1
Vols-au-vent / Puff pastry crackers		Yes	190 - 200	20 - 30	3
		Yes	180 - 190	20 - 40	4 1
		Yes	180 - 190	20 - 40 ***	5 3 1
Lasagne / Flans		—	190 - 200	40 - 65	3
Baked pasta / Cannelloni		—	190 - 200	25 - 45	3

RECIPE	FUNCTION	PREHEAT.	TEMPERATURE (°C)	DURATION (Min.)	SHELF AND ACCESSORIES
Lamb / Veal / Beef / Pork 1 kg		—	190 - 200	60 - 90	3
Roast pork with crackling 2 kg		—	170	110 - 150	2
Chicken / Rabbit / Duck 1 kg		—	200 - 230	50 - 80 **	3
Turkey / Goose 3 kg		—	190 - 200	90 - 150	2
Baked fish / en papillote (fillets, whole)		Yes	180 - 200	40 - 60	3
Stuffed vegetables (tomatoes, courgettes, aubergines)		Yes	180 - 200	50 - 60	2
Toast		—	3 (High)	3 - 6	5
Fish fillets / Steaks		—	2 (Mid)	20 - 30 *	4 3
Sausages / Kebabs / Spare ribs / Hamburgers		—	2 - 3 (Mid - High)	15 - 30 *	5 4
Roast chicken 1-1.3 kg		—	2 (Mid)	55 - 70 **	2 1
Roast beef rare 1 kg		—	2 (Mid)	35 - 50 **	3
Leg of lamb / Shanks		—	2 (Mid)	60 - 90 **	3
Roast potatoes		—	2 (Mid)	35 - 55 **	3
Vegetable gratin		—	3 (High)	10 - 25	3
Lasagna & Meat		Yes	200	50 - 100 ***	4 1
Meat & Potatoes		Yes	200	45 - 100 ***	4 1
Fish & Vegetables		Yes	180	30 - 50 ***	4 1
Complete meal: Fruit tart (level 5)/ lasagne (level 3)/meat (level 1)		Yes	190	40 - 120 ***	5 3 1
Stuffed roasting joints		—	200	80 - 120 ***	3
Cuts of meat (rabbit, chicken, lamb)		—	200	50 - 100 ***	3

* Turn food halfway through cooking.















** Turn food two thirds of the way through cooking (if necessary).

*** Estimated length of time: dishes can be removed from the oven at different times depending on personal preference.

FUNCTIONS	Conventional	Grill	Turbo Grill	Forced Air	Convection Bake	Eco Forced Air
AUTOMATIC FUNCTIONS	Casserole	Meat	Maxi Cooking	Bread	Pizza	Pastry / Cakes
ACCESSORIES	Wire shelf	Oven tray or cake tin on wire shelf	Drip tray / Baking tray or oven tray on wire shelf	Drip tray / Baking tray	Drip tray with 500 ml of water	

TESTED RECIPES

Compiled for the certification authorities in accordance with the standard IEC 60350-1

RECIPE	FUNCTION	PREHEAT	shelf	TEMP. (°C)	DURATION (Min.)	ACCESSORIES* AND NOTES
Shortbread		-	3	150	35 - 50	Drip tray / baking tray
		Yes	3	150	25 - 40	Drip tray / baking tray
		Yes	1 - 4	150	25 - 35	Shelf 4: baking tray Shelf 1: drip tray / baking tray
Small cakes		-	3	170	25 - 35	Drip tray / baking tray
		Yes	3	160	20 - 30	Drip tray / baking tray
		Yes	1 - 4	160	25 - 35	Shelf 4: baking tray Shelf 1: drip tray / baking tray
Fatless sponge cake		-	2	170	30 - 40	Cake tin on wire shelf
		Yes	2	160	30 - 40	Cake tin on wire shelf
		Yes	1 - 4	160	35 - 45	Shelf 4: cake tin on wire shelf Shelf 1: cake tin on wire shelf
2 Apple pies		-	2	185	70 - 90	Cake tin on wire shelf
		Yes	2	175	70 - 90	Cake tin on wire shelf
		Yes	1 - 4	175	75 - 95	Shelf 4: cake tin on wire shelf Shelf 1: cake tin on wire shelf
Toast		-	5	3 (High)	4 - 6	Wire shelf
Hamburgers		-	5	3 (High)	18 - 30	Shelf 5: wire shelf (turn food halfway through cooking)
						Shelf 4: drip tray with water





* You can obtain any accessories that are not supplied from our After-sales service.

The indications in the table are without use of sliding runners. Do the tests without these.

Energy efficiency class (according to standard IEC 60350-1): to carry out the test, use the specific table.

Preheating the empty oven (according to IEC 60350-1): test "CONVENTIONAL", "FORCED AIR", "FAST PREHEAT" functions.

Please note: Pastry function uses upper and lower heating elements only, without forced air circulation. It doesn't require preheating.

FUNCTIONS				
	Pastry Cakes	Convection bake	Forced Air	Grill

CLEANING

Do not use steam cleaning equipment.

Use protective gloves during all operations.

Carry out the required operations with the oven cold.

Disconnect the oven from the power supply.

Do not use wire wool, abrasive scourers or abrasive/corrosive cleaning agents, as these could damage the surfaces of the appliance.

EXTERIOR SURFACES

Clean the surfaces with a damp microfibre cloth. If they are very dirty, add a few drops of pH-neutral detergent. Finish off with a dry cloth.

Do not use corrosive or abrasive detergents. If any of these products inadvertently comes into contact with the surfaces of the appliance, clean immediately with a damp microfibre cloth.

INTERIOR SURFACES

- After every use, start cooling down the oven and then clean it while it is still a bit warm, removing any deposits or stains caused by food residues. To dry any condensation that has formed as a result of cooking food with a high water content, cool the oven completely and then wipe it with a cloth or sponge.
- Clean the glass door with a suitable liquid detergent.
- The oven door can be removed to facilitate cleaning.
- Activate the "Diamond Clean" function for optimum cleaning of the internal surfaces.

ACCESSORIES

Soak the accessories in a washing-up liquid solution after use, handling them with oven gloves if they are still hot.

Food residues can be removed using a washing-up brush or a sponge.

MAINTENANCE

Use protective gloves during all operations.

Carry out the required operations with the oven cold.

Disconnect the oven from the power supply.

REMOVING THE DOOR

1. Open the door fully.

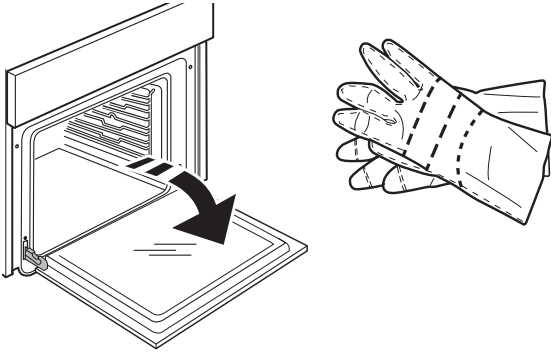

2. Lower the catches as far as they will go.

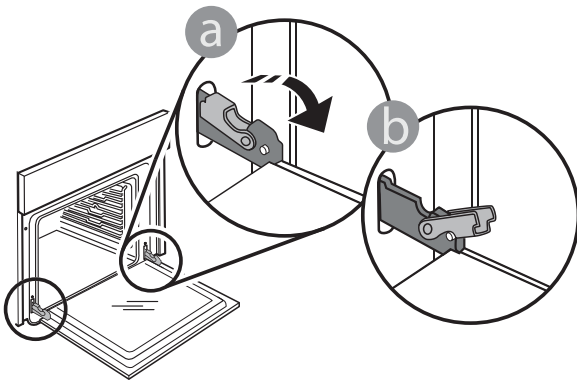

3. Close the door as much as you can.

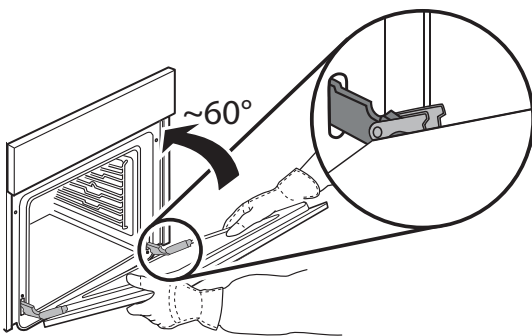

4. Take a firm hold of the door with both hands – do not hold it by the handle. Simply remove the door by continuing to close it while pulling it upwards at the same time until it is released from its seating.

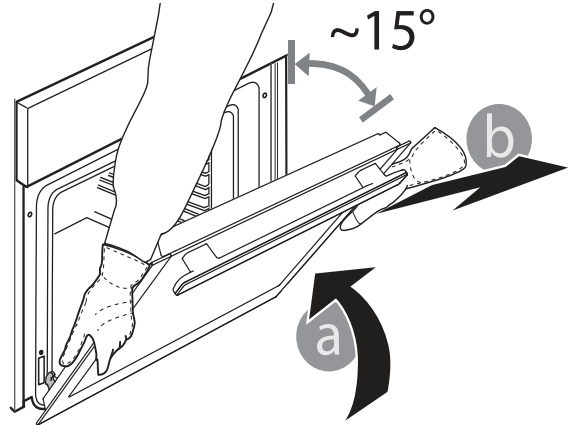

5. Put the door to one side, resting it on a soft surface.

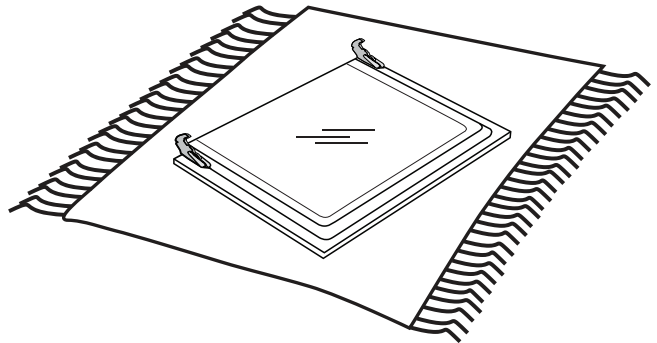

REFITTING THE DOOR

1. Hold the door near the oven and line up the hinge hooks with their seatings.

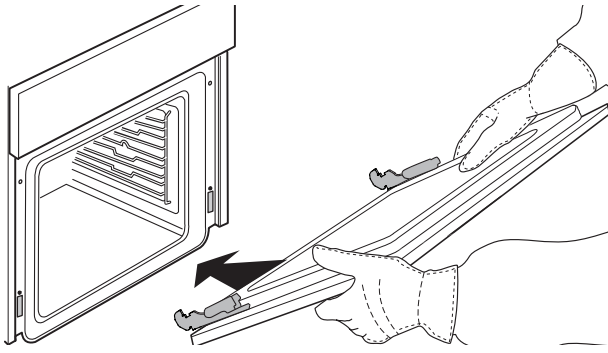

2. Fasten the upper part to the slots.

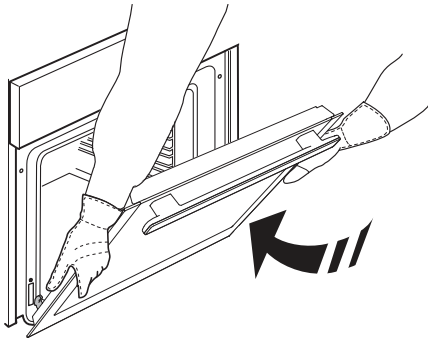

3. Lower the door and then open it fully.

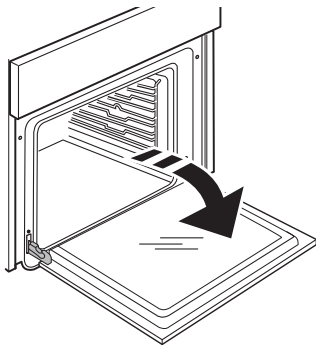

4. Lower the catches into their original position: make sure that you lower them down completely.

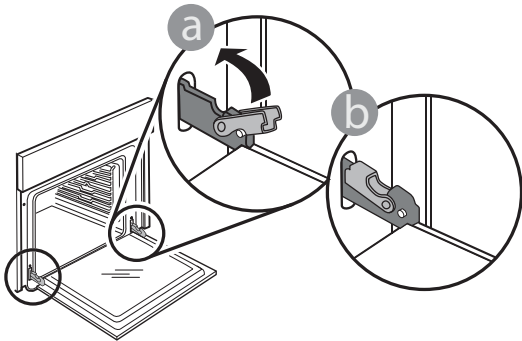

5. Apply gentle pressure to check that the catches are in the correct position.

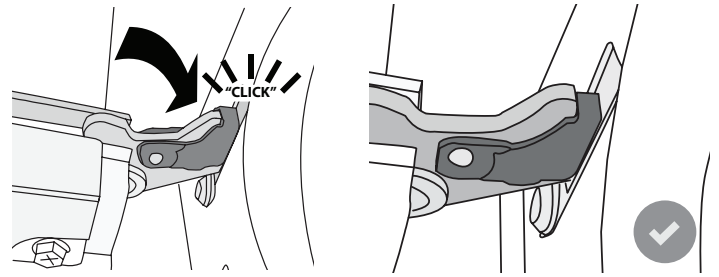

6. Try closing the door and check to make sure that it lines up with the control panel. If it does not, repeat the steps above: the door could become damaged if it does not work properly.

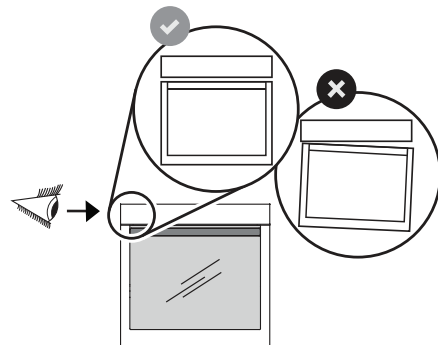
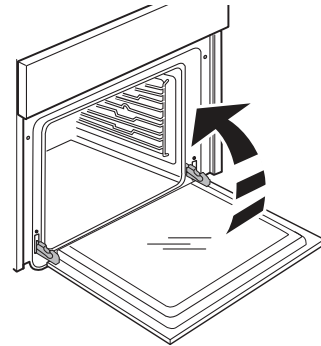

REPLACING THE LAMP

1. Disconnect the oven from the power supply.
2. Unscrew the cover from the light, replace the bulb and screw the cover back on the light.

Please note: Only use 20-40 W/230 V type G9, T300°C halogen bulbs.

The bulb used in the product is specifically designed for domestic appliances and is not suitable for general room lighting within the home (EC Regulation 244/2009).

Light bulbs are available from our After-Sales Service.

- If using halogen bulbs, do not handle them with your bare hands as your fingerprints could cause damage. Do not use the oven until the light cover has been refitted.

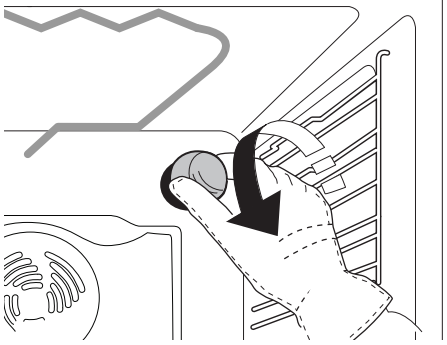

3. Reconnect the oven to the power supply.

LOWERING THE UPPER HEATING ELEMENT

(ONLY IN SOME MODELS)

1. Remove the shelf guides.

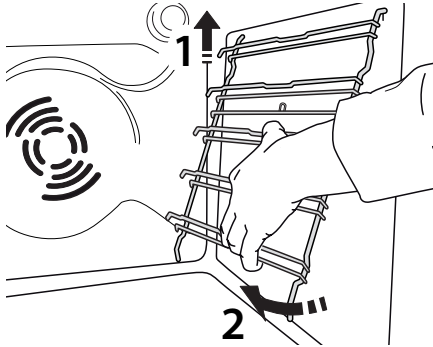

2. Carefully take the heating element out.

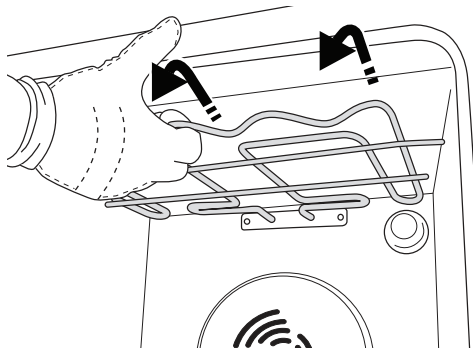

3. Lower the heating element.

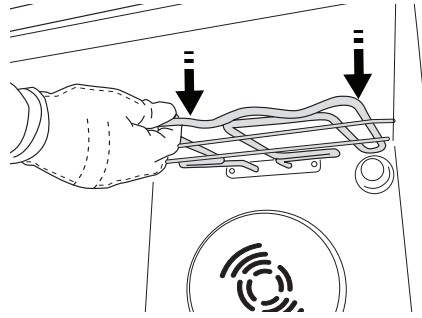

4. To reposition the heating element, lift it up, pulling it slightly towards you, be sure it comes to rest on the lateral supports.

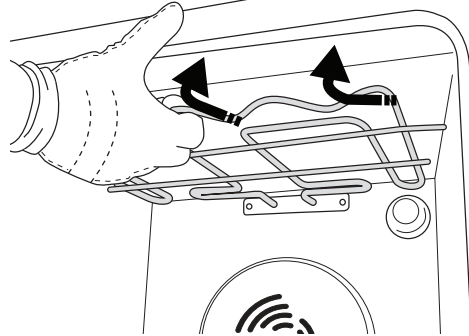

TROUBLESHOOTING

Any problems that arise or faults that occur can often be resolved easily.

Before contacting the After-sales Service, check the following table to see whether you can resolve the problem yourself.

If the problem persists, contact your nearest After-sales Service Centre.



Read the safety instructions carefully before carrying out any of the following work

PROBLEM	POSSIBLE CAUSE	REMEDY
The oven is not working.	Power cut. Disconnection from the mains. Malfunction.	Check for the presence of mains electrical power and whether the oven is connected to the electricity supply. Turn off the oven and restart it to see if the problem persists.
The oven is not heating up.	Function selected. Door open.	Select a different function. Turn off the oven and restart it to see if the fault persists. Close the door and see if the fault persists.
The time is flashing.	Power cut.	You need to reset the time: Follow the instructions given in the "Using the appliance for the first time" section.
The display shows the letter "F" followed by a number.	Fault.	Contact your nearest Client After-sales Service Centre and state the number following the letter "F".
The door will not close properly.	The safety catches are in the wrong position.	Make sure that the safety catches are in the correct position by following the instructions for removing and refitting the door in the "Maintenance" section.

TECHNICAL DATA

 A complete product specification, including the energy efficiency ratings for this oven, can be read and downloaded from our website docs.hotpoint.eu

AFTER-SALES SERVICE

BEFORE CONTACTING OUR AFTER-SALES SERVICE

1. Check whether you can resolve the problem yourself using any of the measures described in the Troubleshooting section.

2. Turn off the oven and restart it to see if the problem persists.

IF THE PROBLEM PERSISTS AFTER HAVING PERFORMED ALL OF THE NECESSARY CHECKS, CONTACT YOUR NEAREST AFTER-SALES SERVICE CENTRE.

To receive assistance, call the number given on the warranty leaflet enclosed with the product or follow the instructions on our website. Be prepared to provide:

- a brief description of the problem;
- the exact model type of your product;
- the assistance code (the number following the word SERVICE on the identification plate attached to the product, which can be seen on the left-hand inside edge when the oven door is open);
- your full address;
- a contact telephone number.

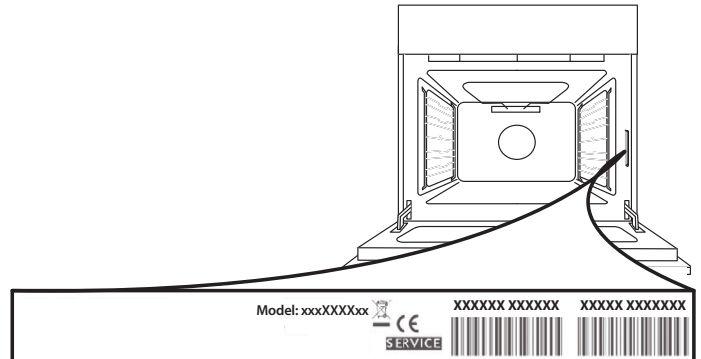

Please note: If repairs are required, contact an authorised service centre that is guaranteed to use original spare parts and perform repairs correctly.

Please refer to the enclosed warranty leaflet for more information on the warranty.

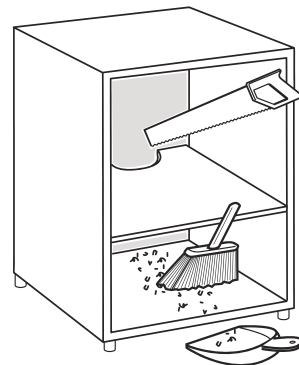
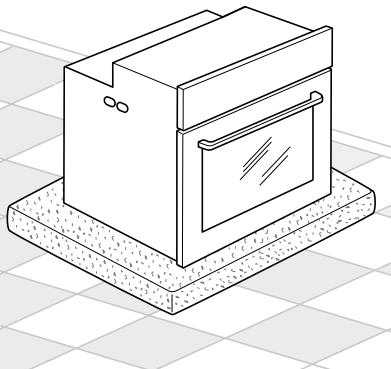
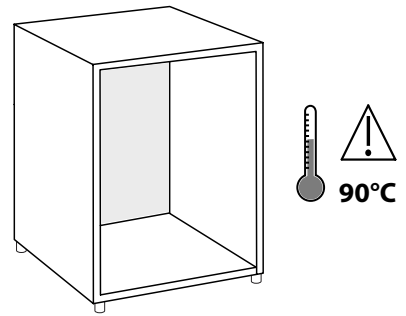
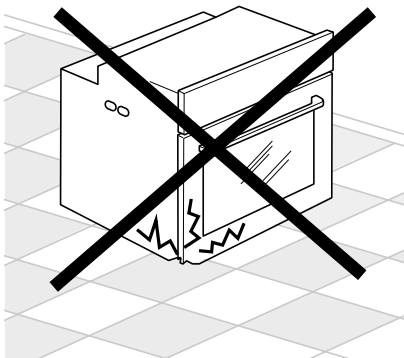
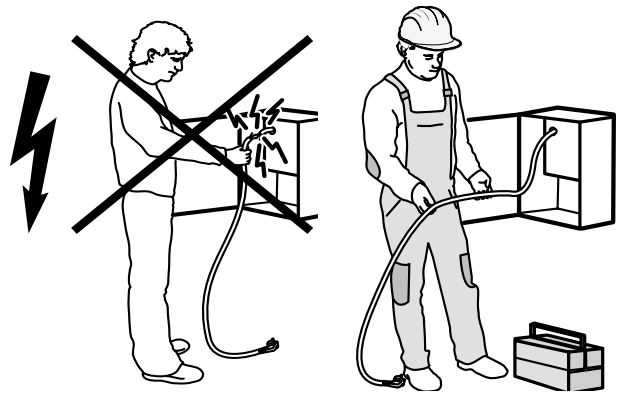
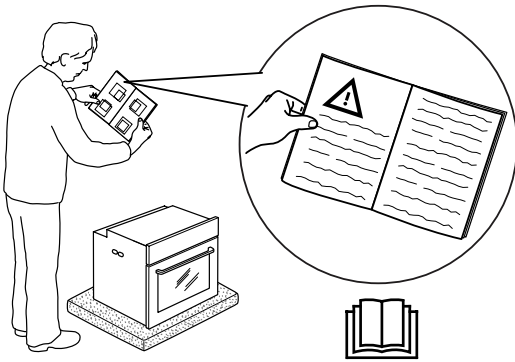
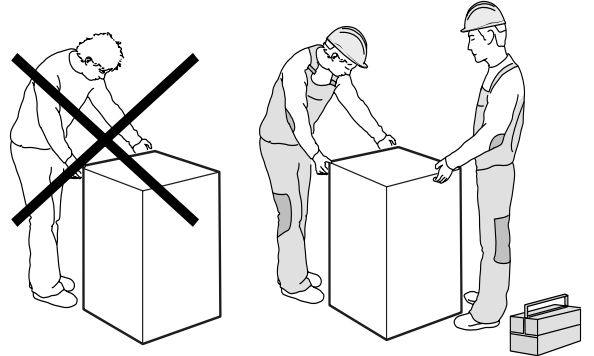
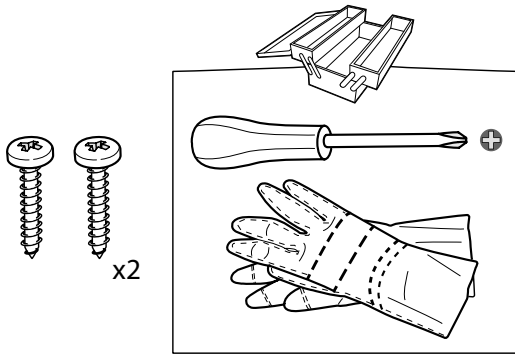

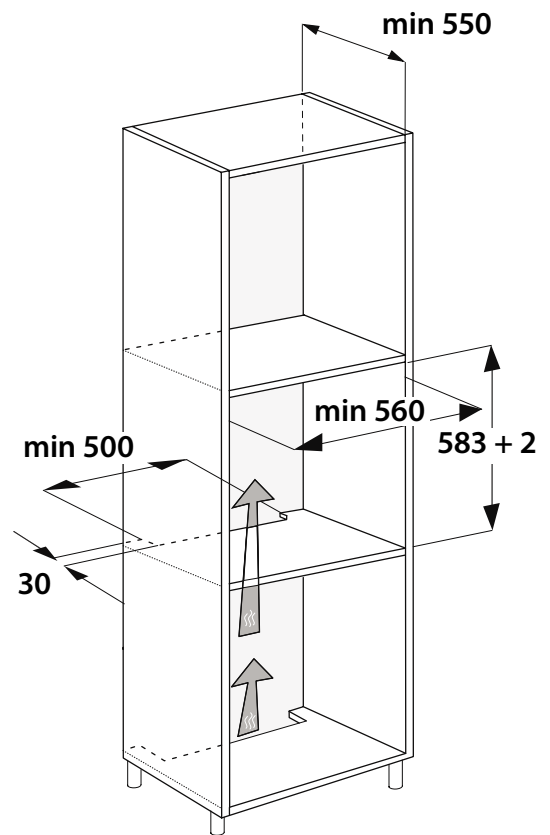
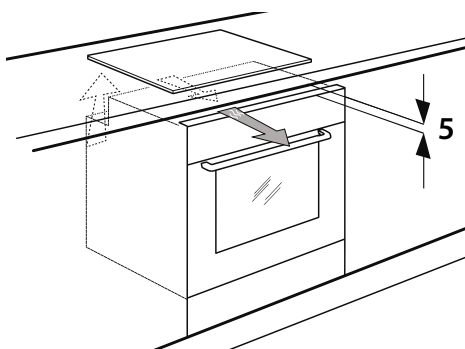
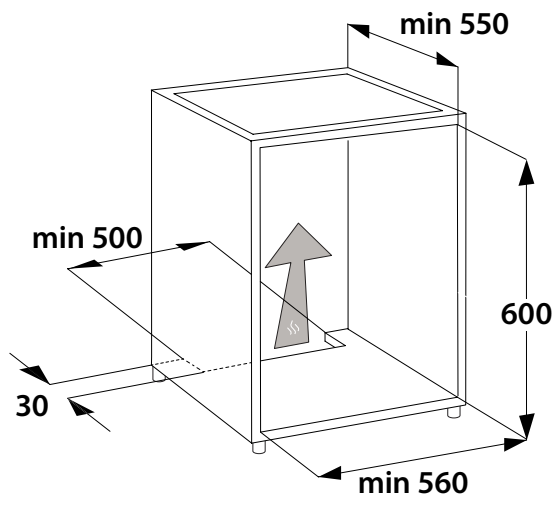
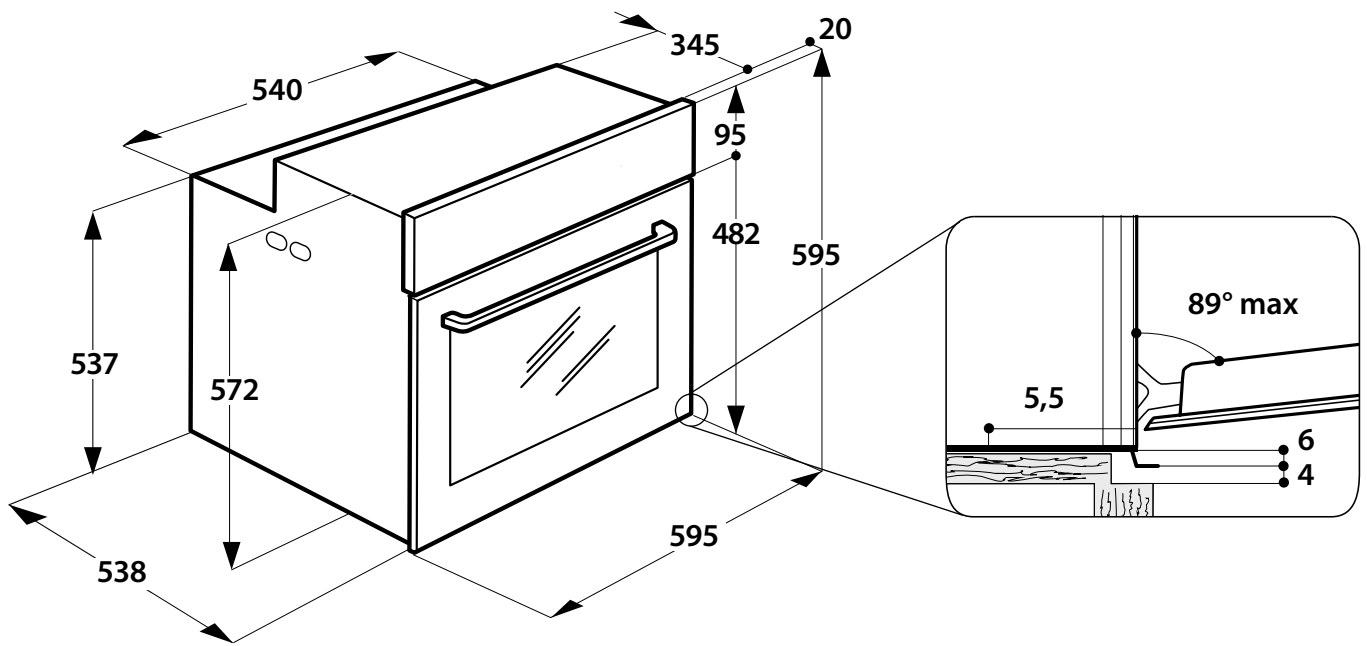

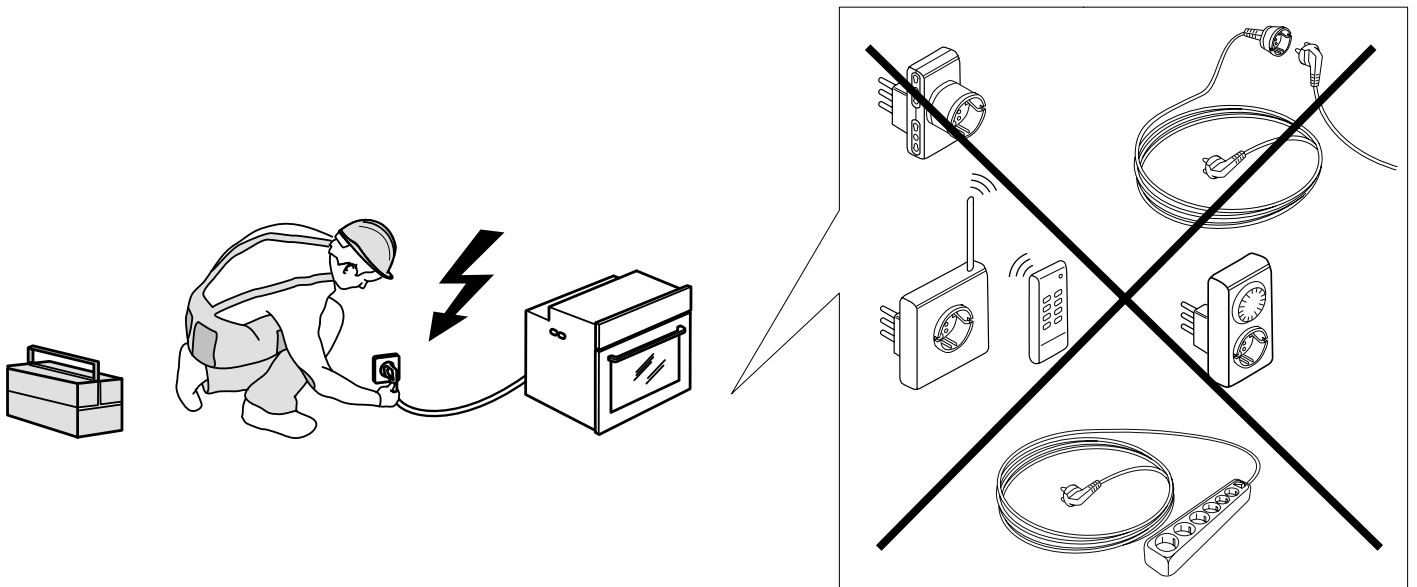
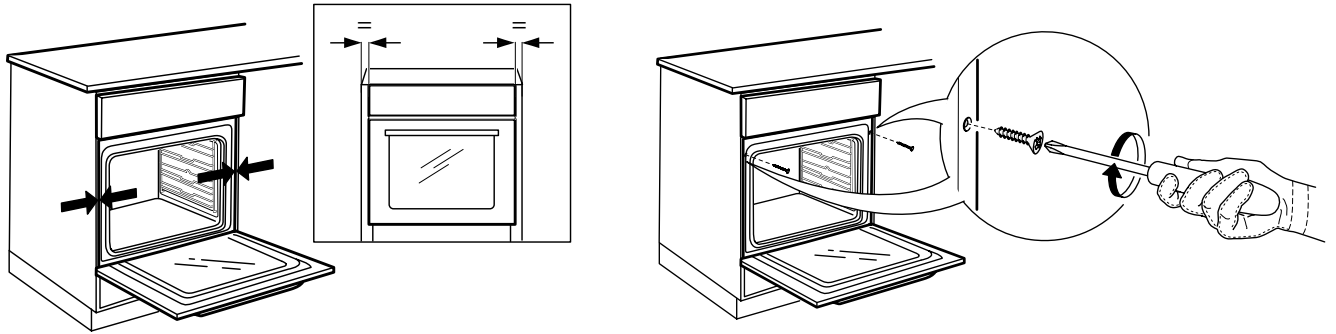
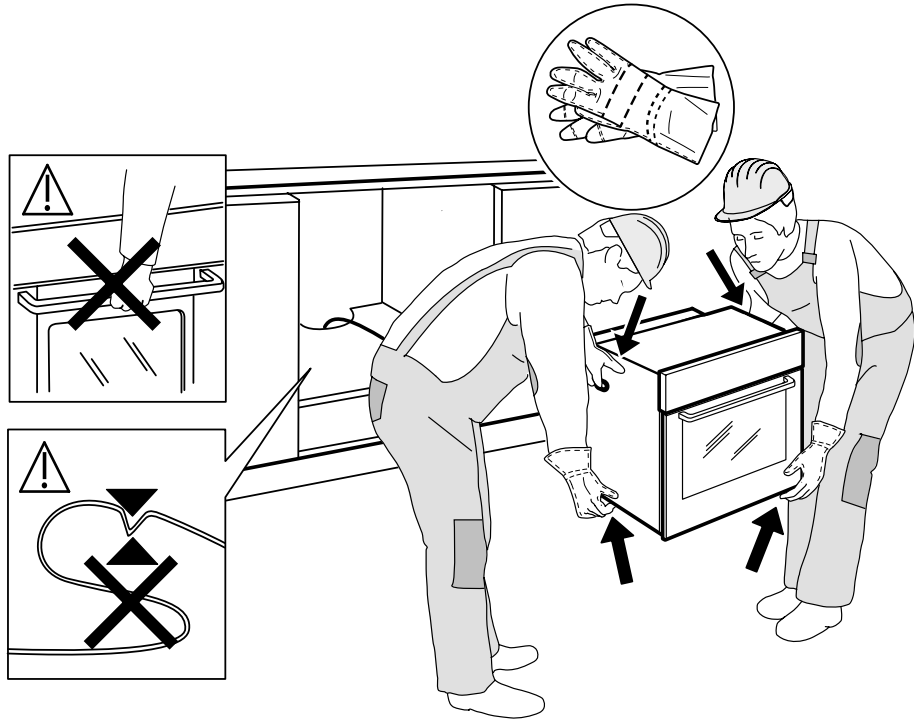

400010886374