

# Operating and installation instructions



## Oven



To avoid the risk of accidents or damage to the appliance it is **essential** to read these instructions before it is installed and used for the first time.

# Contents

---

<b>Warning and Safety instructions</b> .....	5
<b>Caring for the environment</b> .....	15
<b>Oven overview</b> .....	16
<b>Oven controls</b> .....	17
Function selector .....	18
Temperature selector .....	18
Temperature indicator light  .....	18
Clock/timer .....	19
Display.....	19
Sensor controls .....	19
<b>Features</b> .....	20
Model numbers .....	20
Data plate .....	20
Items supplied .....	20
Accessories supplied and available to order.....	20
Side runners .....	21
Baking tray, universal tray and rack with non-tip notches .....	21
FlexiClip telescopic runners HFC 70-C .....	22
Oven controls .....	28
Safety features .....	28
System lock  .....	28
Cooling fan .....	28
Vented oven door .....	28
Door lock - Pyrolytic cleaning .....	28
PerfectClean treated surfaces .....	29
<b>Using for the first time</b> .....	30
Before using for the first time .....	30
Heating up the oven for the first time.....	31
<b>Overview of functions</b> .....	32
<b>Tips on saving energy</b> .....	34
<b>Using the oven</b> .....	36
Simple operation .....	36
Cooling fan .....	36
Pre-heating the oven .....	37

<b>Clock/timer</b> .....	38
Display .....	38
Symbols on the display .....	38
Sensors .....	38
Setting the time .....	39
Time display .....	39
At the end of the duration.....	39
Using the minute minder  .....	40
To set the minute minder .....	40
To change the minute minder duration.....	41
To delete the minute minder duration.....	41
Switching on and off automatically .....	42
Setting a cooking duration .....	42
At the end of the cooking duration:.....	43
Setting a cooking duration and end of cooking duration .....	44
Changing the cooking duration .....	45
Deleting a cooking duration .....	46
Deleting the end of cooking duration .....	46
Changing the time of day .....	47
Changing settings .....	48
<b>Baking</b> .....	50
Notes on using the baking charts .....	51
Baking charts .....	52
Creamed mixture.....	52
Rubbed in mixture.....	54
Yeast mixtures and quark dough.....	56
Whisked mixture.....	58
Choux pastry, puff pastry, meringue.....	59
<b>Roasting</b> .....	60
Notes on using the roasting charts .....	61
Roasting charts .....	62
Beef, veal.....	62
Pork .....	63
Lamb, game .....	64
Poultry, fish.....	65
<b>Low temperature cooking</b> .....	66
<b>Grilling</b> .....	68
Notes on the grilling chart .....	70
Grilling chart .....	71

# Contents

---

<b>Further applications</b> .....	72
Defrost .....	72
Gentle bake .....	73
Frozen food/Ready meals.....	74
Drying food.....	75
Heat crockery .....	76
<b>Cleaning and care</b> .....	77
Unsuitable cleaning agents .....	77
Tips.....	78
Normal soiling.....	78
Stubborn soiling (excluding the FlexiClip runners).....	79
Stubborn soiling on the FlexiClip runners .....	80
Pyrolytic cleaning  of the oven interior .....	81
Setting up for pyrolytic cleaning.....	81
Starting Pyrolytic cleaning.....	82
To delay the start time of the pyrolytic cleaning programme .....	83
At the end of pyrolytic cleaning.....	83
If pyrolytic cleaning is cancelled .....	84
Removing the door.....	85
Dismantling the door .....	86
Refitting the door.....	90
Removing the side runners with FlexiClip runners .....	91
Lowering the top heat/grill element.....	92
<b>Problem solving guide</b> .....	93
<b>After Sales / Warranty</b> .....	97
<b>Electrical connection</b> .....	98
Oven .....	98
Electrical connection: Other countries .....	99
<b>Building-in diagrams</b> .....	100
Appliance and niche dimensions .....	100
Installation in a base unit.....	100
Installation in a tall unit.....	101
Dimensions of oven front .....	102
<b>Installing the oven</b> .....	103
<b>Note for test institutes</b> .....	104
Test food acc. to EN 60350-1 .....	104
Energy efficiency class .....	105
Data sheets for household ovens.....	105

## Warning and Safety instructions

---

This appliance complies with statutory safety requirements. Inappropriate use can, however, lead to personal injury and damage to property.

To avoid the risk of accidents and damage to the appliance, please read these instructions carefully before using it for the first time. They contain important notes on installation, safety, use and maintenance.

Miele cannot be held liable for damage or injury caused by non-compliance with these instructions.

Keep these instructions in a safe place and ensure that new users are familiar with the contents. Pass them on to any future owner.

# Warning and Safety instructions

---

## Correct application

- ▶ This oven is intended for use in domestic households and similar working and residential environments.
- ▶ The oven is not intended for outdoor use.
- ▶ This oven is intended for domestic use only to cook food, and in particular to bake, roast, grill, cook, defrost and dry food. Any other use is not supported by the manufacturer and could be dangerous.
- ▶ People with reduced physical, sensory or mental capabilities, or lack of experience or knowledge who are not able to use the appliance safely on their own must be supervised whilst using it. They may only use it unsupervised if they have been shown how to use it safely and recognise and understand the consequences of incorrect operation.
- ▶ This oven is supplied with a special lamp to cope with particular conditions (e.g. temperature, moisture, chemical resistance, abrasion resistance and vibration). This special lamp must only be used for the purpose it is intended for. It is not suitable for room lighting.

### Safety with children

- ▶ Children under 8 years of age must be kept away from the appliance unless they are constantly supervised.
- ▶ Children 8 years and older may only use the oven unsupervised if they have been shown how to use it safely and recognise and understand the consequences of incorrect operation.
- ▶ Children must not be allowed to clean or maintain the appliance unsupervised.
- ▶ Please supervise children in the vicinity of the oven and do not let them play with it.
- ▶ Danger of suffocation. Packaging, e.g. plastic wrappings, must be kept out of the reach of babies and children. Whilst playing, children could become entangled in packaging or pull it over their head and suffocate.
- ▶ Danger of burning. Children's skin is far more sensitive to high temperatures than that of adults. External parts of the oven such as the door glass, control panel and the vents become quite hot during use. Do not let children touch the oven whilst it is in use.
- ▶ Danger of burning.  
Children's skin is far more sensitive to high temperatures than that of adults. The oven gets hotter during pyrolytic cleaning than it does in normal use. Do not let children touch the oven whilst the Pyrolytic cleaning programme is running.
- ▶ Danger of injury. The door can support a maximum weight of 15 kg.  
Do not let children sit on the door, lean against it or swing on it. They could injure themselves.

# Warning and Safety instructions

---

## Technical safety

- ▶ Unauthorised installation, maintenance and repairs can cause considerable danger for the user. Installation, maintenance and repairs must only be carried out by a Miele authorised technician.
- ▶ Never use a damaged oven. It could be dangerous. Check it for visible signs of damage before using it.
- ▶ Reliable and safe operation of this oven can only be assured if it has been connected to the mains electricity supply.
- ▶ The electrical safety of this appliance can only be guaranteed when correctly earthed. It is essential that this standard safety requirement is met. If in any doubt please have the electrical installation tested by a qualified electrician.
- ▶ To avoid the risk of damage to the oven, make sure that the connection data on the data plate (voltage and frequency) match the mains electricity supply before connecting the oven to the mains. Consult a qualified electrician if in doubt.
- ▶ Do not connect the appliance to the mains electricity supply by a multi-socket unit or an extension lead. These do not guarantee the required safety of the appliance (fire hazard).
- ▶ For safety reasons, this appliance may only be used after it has been built in.
- ▶ The oven must not be used in a non-stationary location (e.g. on a ship).
- ▶ Tampering with electrical connections or components and mechanical parts is highly dangerous to the user and can cause operational faults.  
Never open the casing of the appliance.
- ▶ While the appliance is under guarantee, repairs should only be undertaken by a Miele authorised service technician. Otherwise the guarantee is invalidated.



## Warning and Safety instructions

---

- ▶ Miele can only guarantee the safety of the appliance when genuine original Miele replacement parts are used. Faulty components must only be replaced by Miele spare parts.
- ▶ If the connection cable is damaged or if the oven is supplied without a cable, it must be replaced or fitted with a special connection cable by a Miele authorised technician (see "Electrical connection").
- ▶ During installation, maintenance and repair work, the appliance must be disconnected from the mains electricity supply, e.g. if the oven lighting is faulty (see "Problem solving guide" and "Electrical connection").
- ▶ In order to function correctly, the oven requires an adequate supply of cool air. Ensure that the supply of cool air is not impaired (e.g. by heat insulation strips in the housing unit). Please also ensure that the cool air supply is not unduly heated by other heat sources such as a solid fuel stove.
- ▶ If the oven is installed behind a furniture panel (e.g. a door), ensure that the door is never closed whilst the oven is in use. Heat and moisture can build up behind a closed furniture panel and cause subsequent damage to the oven, the housing unit and the floor. Do not close the door until the oven has cooled down completely.

# Warning and Safety instructions

---

## Correct use





Danger of burning.

The oven becomes hot when in use.

You could burn yourself on the heating elements, oven interior, cooked food or oven accessories.

Wear oven gloves when placing food in the oven, turning or removing it and when adjusting oven shelves etc. in a hot oven.

- ▶ Due to the high temperatures radiated, objects left near the oven when it is in use could catch fire.  
Do not use the oven to heat up the room.
- ▶ Oil and fat can ignite if overheated. Never leave the oven unattended when cooking with oil and fat.  
If it does ignite do not put the flames out with water. Switch the oven off immediately and then suffocate the flames by keeping the oven door closed.
- ▶ Grilling food for an excessively long time can cause it to dry out with the risk of catching fire.  
Do not exceed recommended grilling times.
- ▶ Some types of food dry out quickly and can self-ignite if high grill temperatures are used.  
Never use the grill to finish baking part-cooked rolls or bread or to dry flowers or herbs. Use Fan plus  or Conventional heat  for this type of procedure.
- ▶ If using alcohol in your recipes, please be aware that high temperatures can cause the alcohol to vaporise. The vapour can catch fire on hot heating elements.

## Warning and Safety instructions

---

▶ When using residual heat to keep food in the oven warm, the high moisture content and amount of condensation in the oven can cause corrosion damage. The control panel, the worktop or the housing unit can also suffer damage.



When using residual heat do not switch the oven off. Instead set the temperature to the lowest setting and leave the oven on the selected function. The fan will then remain on automatically and dissipate the moisture.

▶ Food which is stored in the oven or left in it to be kept warm can dry out and the moisture released can lead to corrosion damage in the oven.

Always cover food that is left in the oven to keep warm.

▶ A build-up of heat can cause the enamel on the floor of the oven to crack or shatter.

Do not line the floor of the oven with anything, e.g. aluminium foil or oven liners.

If you wish to place dishes on the floor of the oven during cooking, or place crockery on the floor of the oven to heat it up, you can do so, but only with the Fan plus  or Gentle bake  function.

▶ The enamelling on the oven floor can become damaged by items being pushed around on it.

If using the oven to store pots and pans, ensure that you avoid pushing them around on the oven floor.

▶ If cold liquid is poured onto a hot surface steam will occur, which can cause scalding. The sudden change in temperature can also damage enamel surfaces.

Do not pour cold liquid directly onto hot enamelled surfaces.

▶ It is important that the temperature in the food being cooked is evenly distributed and sufficiently high. Stir and / or turn it to ensure even heat distribution.

## Warning and Safety instructions

---

- ▶ Plastic containers which are not suitable for use in an oven can melt at high temperatures and can even damage the oven or catch fire.  
Only use plastic containers which are declared by the manufacturer as being suitable for use in an oven. Follow the manufacturer's instructions on use.
- ▶ Do not heat up food in closed containers e.g. tins or sealed jars in the oven, as pressure will build up in the container, causing it to explode.
- ▶ You could injure yourself on the open oven door or trip over it. Avoid leaving the door open unnecessarily.
- ▶ The door can support a maximum weight of 15 kg. Do not sit on or lean against an open door, and do not place heavy objects on it. Also make sure that nothing can get trapped between the door and the oven cavity. The oven could get damaged.

# Warning and Safety instructions

---

## **Stainless steel appliances**

- ▶ Adhesives will damage the stainless steel surface and cause it to lose its dirt-repellent protective coating. Do not use sticky notes, transparent adhesive tape, masking tape or other types of adhesive on the stainless steel surface.
- ▶ The surface is susceptible to scratching. Even magnets can cause scratching.

## **Cleaning and care**

- ▶ Do not use a steam cleaning appliance to clean this appliance. The steam could reach electrical components and cause a short circuit.
- ▶ Scratches on the door glass can result in the glass breaking. Do not use abrasive cleaners, hard sponges, brushes or sharp metal tools to clean the door glass.
- ▶ The side runners can be removed for cleaning (see "Cleaning and care"). Ensure that they are replaced correctly.
- ▶ Coarse soiling should be removed before running the Pyrolytic cleaning programme. If not removed, coarse soiling can smoke and cause the Pyrolytic cleaning programme to switch itself off.
- ▶ In areas which may be subject to infestation by cockroaches or other vermin, pay particular attention to keeping the appliance and its surroundings clean at all times. Any damage caused by cockroaches or other vermin will not be covered by the warranty.

## Warning and Safety instructions

---

### Accessories

- ▶ Only use genuine original Miele accessories and spare parts with this appliance. Using accessories or spare parts from other manufacturers will invalidate the warranty and Miele cannot accept liability.
- ▶ If you have a Miele HUB 5000-M, HUB 5001-M, HUB 5000-XL or a HUB 5001-XL oven dish, do not place it on Shelf level 1. This would damage the floor of the oven. The very small gap between the bottom of the dish and the oven floor would cause a build-up of heat and could cause the enamel to crack or chip.  
Never place a Miele oven dish on the top rail of Shelf level 1 as it will not be held securely in this position by the anti-tip notches on the runners.  
In general it is best to use Shelf level 2.
- ▶ Remove all accessories as well as the runners and any extra accessories such as FlexiClip runners from the oven interior before starting the Pyrolytic cleaning programme.  
The high temperatures needed for pyrolysis will damage them.

### Disposal of the packing material

The packaging is designed to protect the appliance from damage during transportation. The packaging materials used are selected from materials which are environmentally friendly for disposal and should be recycled.

Recycling the packaging reduces the use of raw materials in the manufacturing process and also reduces the amount of waste in landfill sites.

### Disposing of your old appliance

Electrical and electronic appliances often contain valuable materials. They also contain specific materials, compounds and components, which were essential for their correct function and safety. These could be hazardous to human health and to the environment if disposed of with your domestic waste or if handled incorrectly. Please do not, therefore, dispose of your old appliance with your household waste.



Please dispose of it at your local community waste collection / recycling centre for electrical and electronic appliances, or contact your dealer or Miele for advice. You are also responsible (by law, depending on country) for deleting any personal data that may be stored on the appliance being disposed of. Please ensure that your old appliance poses no risk to children while being stored prior to disposal.

# Oven overview

---

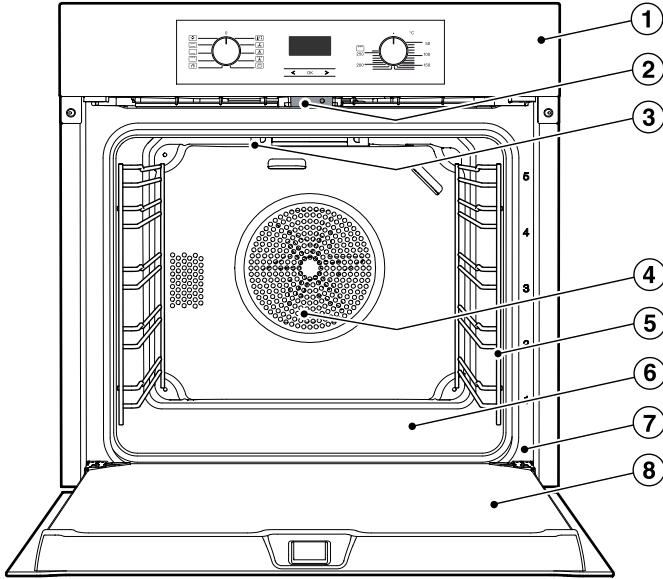

- ① Oven controls
- ② Door lock - Pyrolytic cleaning
- ③ Top heat/grill element
- ④ Air inlet for the fan with ring heating element behind it
- ⑤ Side runners with 5 shelf levels
- ⑥ Oven floor with bottom heat element underneath it
- ⑦ Front frame with data plate
- ⑧ Door



# Oven controls

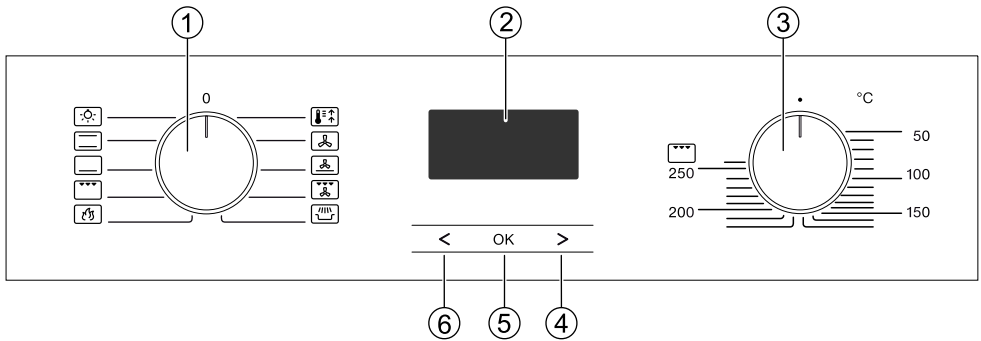

- ① Function selector  
For selecting oven functions
- ② Clock/timer  
For displaying the time of day and settings
- ③ Temperature selector  
For setting the temperature
- ④ Button >  
For modifying times and settings
- ⑤ OK button  
For selecting functions and confirming settings
- ⑥ Button <  
For modifying times and settings

# Oven controls

---











## Function selector

Use the function selector to select the required function and switch on the oven lighting independently.

It can be turned clockwise or anti-clockwise.

In the **0** position it can be retracted by pressing it in.

### Functions

-  *Lighting*
-  *Conventional heat*
-  *Bottom heat*
-  *Grill*
-  *Pyrolytic cleaning*
-  *Rapid heat-up*
-  *Fan plus*
-  *Intensive bake*
-  *Fan grill*
-  *Gentle bake*

## Temperature selector

Use the temperature selector to select the temperature for the cooking processes.

It can be turned clockwise until a resistance is felt and then back again. The temperature selector can be retracted when it is in the **•** position by pressing it in.

The temperature settings are marked on the temperature selector and on the control panel with ovens.

### Temperature indicator light

The temperature indicator light  on the display lights up whenever the oven is heating up.

As soon as the set temperature is reached:

- The oven heating switches off.
- The temperature indicator light goes out.

The temperature control unit ensures that the oven heating and the temperature indicator light switch back on if the oven temperature falls below the level set.

## **Clock/timer**

The clock/timer is operated via the **display** and the <, *OK* and > **sensor controls**.

### **Display**

The display shows the time of day or your settings.

It goes dark if settings are not being entered.

Please refer to "Clock/timer" for more information.

### **Sensor controls**

The sensor controls respond to the touch of a fingertip. Every touch on the sensors is confirmed by an audible tone.

The tone can be switched off by changing setting *P 4* to status *5 1* (see "Clock/timer - Changing settings").

# Features

---

## Model numbers

A list of the models described in these operating instructions can be found on the back page.

## Data plate

The data plate is located on the front frame, visible when the door is open.

The data plate states the model number of your oven, the serial number as well as connection data (voltage, frequency and maximum connected load).

Please have this information to hand, should you need to contact Miele regarding any questions or problems.

## Items supplied

The oven is supplied with:

- the operating and installation instructions for using the oven,
- screws for securing your oven in the housing unit,
- various accessories.

## Accessories supplied and available to order

Accessories will vary depending on model.

Your oven will be supplied with side runners, a universal tray and a rack. Depending on model, your oven may also come supplied with some or several of the accessories listed here.

All the accessories listed as well as the cleaning and care products are designed for Miele ovens.

These are available to order via the Miele Webshop, the Miele Spare Parts Department (see end of this booklet for contact details) or from your Miele dealer.

When ordering, please quote the model number of your oven and the reference number of the accessories required.

## Side runners

Side runners for trays, racks and Miele oven dishes are fitted on either side of the oven cavity for shelf levels 1, 2, 3 and 4.

The numbers for the shelf levels are marked on the front frame.

Each level consists of two rails, one above the other.

Accessories (e.g. the rack) can be used on any level. They are pushed into the oven between the two rails.

FlexiClip telescopic runners (depending on model) are fitted on levels 1, 2 and 3. They are fitted on the upper rail.

The side runners can be removed for cleaning (see "Cleaning and care").

## Baking tray, universal tray and rack with non-tip notches

Baking tray HBB 71:

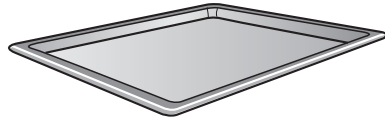

Universal tray HUBB 71:

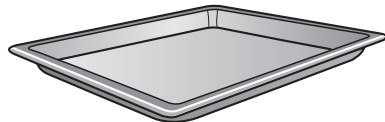

Rack HBBR 71:

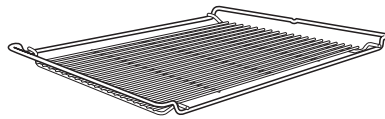

These accessories are inserted into the oven between the two rails of a side runner.

Always position the rack as illustrated.

The accessories have non-tip safety notches half way along the short edges which prevent them from being pulled right out when they only need to be pulled partially out.



If you are using the universal tray with the rack on top, insert the tray between the rails of the side runners and the rack will automatically slide in above them.

The enamelled surfaces have been treated with PerfectClean.

# Features

## FlexiClip telescopic runners HFC 70-C

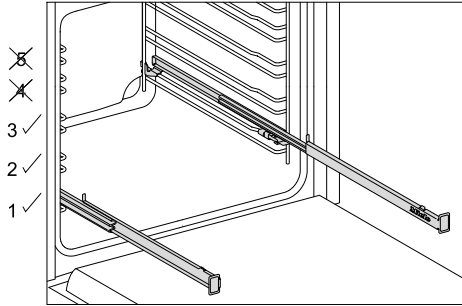

FlexiClip telescopic runners can only be fitted on levels 1, 2 and 3.

The FlexiClip telescopic runners can be drawn right out of the oven individually to give a good overview of cooking in progress.

Push the FlexiClip telescopic runners right into the oven cavity before placing accessories on them.

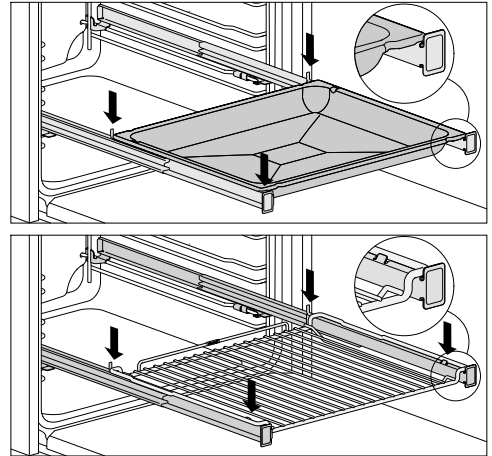

To prevent the risk of accessories sliding off the telescopic runners:

- Make sure that they are sitting securely on their runners in between the stoppers at either end of each runner.
- Always place the rack with the loading surface in the lower position on the FlexiClip telescopic runners.

The FlexiClip telescopic runners can support a maximum load of 15 kg.

Because the FlexiClip telescopic runners sit on the top rail of the side runners, the gap between the level the FlexiClip telescopic runners are on and the one above is smaller than if, for instance, racks were fitted on each level. Cooking results will be affected if the gap is too small.

If you need to use more than one baking tray, universal tray or rack at a time:

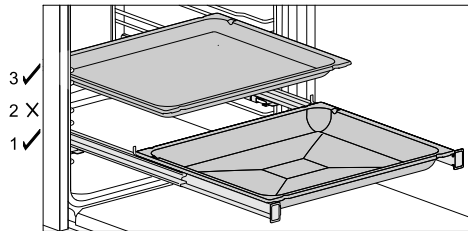

- Place the baking tray, universal tray or rack on the FlexiClip telescopic runners.
- Leave at least one shelf level free between it and any baking tray, universal tray or rack above it.

If you are using the universal tray with a rack on top of it:

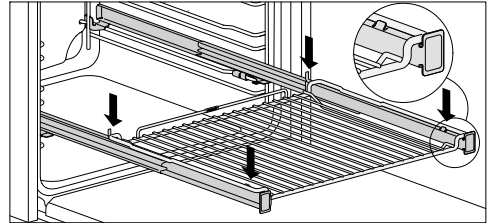

- Place the universal tray together with the rack on the FlexiClip telescopic runners. The rack will automatically slide between the rails of the shelf level above the telescopic FlexiClip runners.
- Leave at least one shelf level free between it and any baking tray, universal tray or rack above it.

# Features

## Fitting the FlexiClip telescopic runners

 Danger of burning.  
Make sure the oven heating elements are switched off. The oven must be cool.

Preferably fit the FlexiClip telescopic runners onto level 1. You can then use them for food which should be cooked on level 2.

One level of the side runners consists of two rails. The FlexiClip telescopic runners are fitted on the upper rail of the two rails that make up a shelf level.

The FlexiClip telescopic runner with the Miele logo is fitted on the right.

When fitting the FlexiClip telescopic runners, **do not** extend them. If the FlexiClip telescopic runners are difficult to pull out after fitting, you may need to pull firmly on them once to release them.

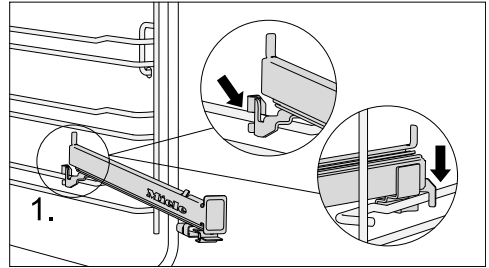

- Hook the FlexiClip telescopic runner onto the front of the top rail of a side runner (1.).

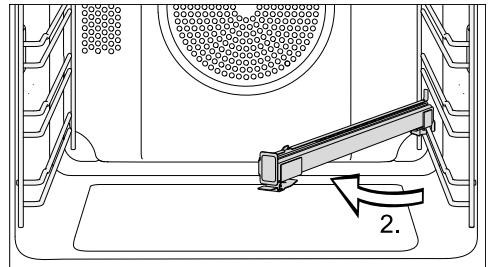

- Then hold it at an angle in towards the middle of the oven cavity (2.).



## Removing the FlexiClip telescopic runners

- Push the FlexiClip telescopic runner in all the way.

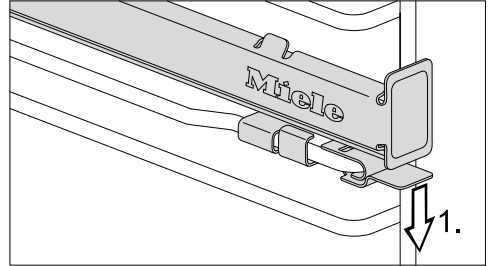

- Push down on the tab at the front of the FlexiClip telescopic runner (1.).

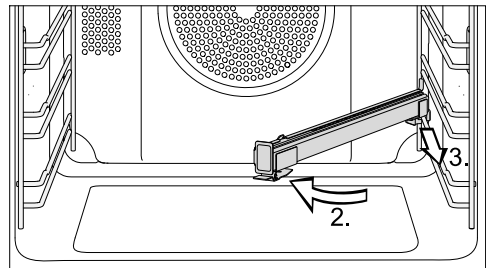

- Swing the FlexiClip telescopic runner towards the middle of the oven cavity (2.), then pull it forwards along the top rail (3.).
- Lift the FlexiClip telescopic runner off the rail and take it out of the oven.

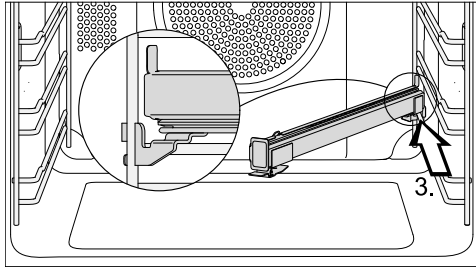

- Slide the FlexiClip telescopic runner at an angle along the top rail as far as it will go (3.).

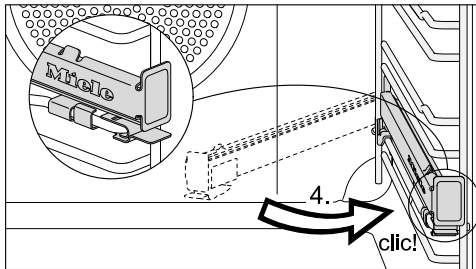

- Then swing it back to the side of the oven cavity and secure it to the top rail with an audible click (4.).

# Features

---

## Round baking tray HBF 27-1



The round baking tray is suitable for cooking pizza, shallow cakes made with yeast or whisked mixtures, sweet and savoury tarts, baked desserts, flat bread, and can also be used for frozen cakes and pizzas.

The enamelled surface has been treated with PerfectClean.

## Perforated baking tray HBBL 71

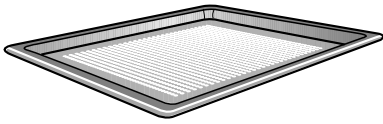

The perforated baking tray has been specially designed for baking fresh yeast and quark dough items, bread and rolls.

The fine perforations help to brown the underside of food.

The tray can also be used for drying fruit and vegetables.

The enamelled surface has been treated with PerfectClean.

The round perforated baking tray HBFP 27-1 can be used for the same things.

## Baking stone HBS 60

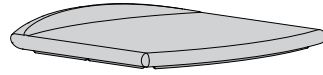

The baking stone is ideal for items which need a well baked base such as pizza, quiche, bread, bread rolls and savoury snacks.

The baking stone is made from heat retaining fire brick and is glazed. Place it directly on the rack.

A paddle made of untreated wood is supplied with it for placing food on the baking stone and taking it off.

## Anti-splash insert HGBB 71

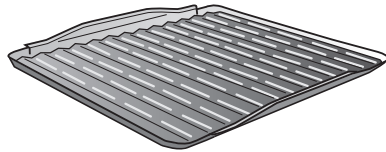

The anti-splash insert fits in the universal tray.

The juices from the food being grilled or roasted collect under the insert. This prevents them from spitting and making the oven dirty. The juices can then be used for making gravy and sauces.

The enamelled surface has been treated with PerfectClean.

## HUB Gourmet oven dishes HBD Gourmet oven dish lids

The Miele gourmet oven dishes, unlike other oven dishes, slide into the oven on the side runners. They have non-tip safety notches like the rack to prevent them being pulled out too far. They also have a non-stick coating.

Gourmet oven dishes are available in two sizes. The width and the height are the same for both.

Suitable lids are available separately. Please quote the model number when ordering a lid.

### Depth: 22 cm

HUB 5000-M  
HUB 5001-M \*

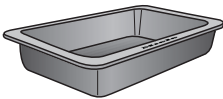

HBD 60-22

### Depth: 35 cm

HUB 5001-XL \*

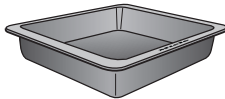

HBD 60-35

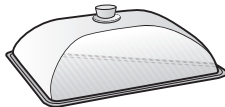
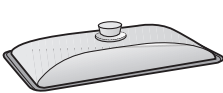

\* suitable for use on induction hobs

## Handle HEG

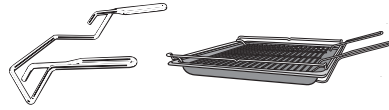

The handle makes it easier to take the universal tray, baking tray and rack out of the oven, or to put them into it.

## Miele microfibre cloth

Light soiling and fingerprints can be easily removed with the microfibre cloth.

## Miele oven cleaner

Miele oven cleaner is suitable for removing very stubborn soiling. It is not necessary to pre-heat the oven beforehand.

# Features

---

## Oven controls

The oven controls are used to operate the various cooking functions for baking, roasting and grilling.

They are also used for

- Time of day display
- Minute minder
- Switching cooking processes on and off automatically
- Selecting settings

## Safety features

### System lock

The system lock prevents the oven from being used unintentionally (see "Clock/timer - Altering settings – P 3"). When the system lock is engaged  will appear in the display.

## Cooling fan

The cooling fan will come on automatically when a cooking programme is started. The cooling fan mixes hot air from the oven cavity with cool room air before venting it out into the kitchen through vents located between the appliance door and the control panel.

The cooling fan will continue to run for a while after the oven has been switched off to prevent any humidity building up in the oven, on the control panel or in the oven housing unit.

This cooling fan will switch itself off automatically after a certain period of time.

## Vented oven door

The oven door glass panes have a heat-reflecting coating.

When the oven is operating, air is passed through the door to keep the outer pane cool.

The door can be removed and dismantled for cleaning (see "Cleaning and care").

## Door lock - Pyrolytic cleaning

For safety reasons the door is locked as soon as the Pyrolytic cleaning programme is started. After the Pyrolytic cleaning programme has finished, the door will remain locked until the temperature in the oven has fallen below 280 °C.

## PerfectClean treated surfaces

PerfectClean surfaces have very good non-stick properties and are much easier to keep clean than conventional enamel surfaces, if cleaned regularly.

Food can be taken off these surfaces easily, and soiling from baking and roasting is simple to remove.

Food can be sliced or cut up on PerfectClean surfaces.

Do not use ceramic knives as these will scratch the PerfectClean surface.

Surfaces treated with PerfectClean enamel can be cleaned as you would clean glass.

Read the instructions in "Cleaning and care" so that the benefits of the non-stick properties and easy cleaning are retained.

The following have all been treated with PerfectClean:

- Universal tray
- Baking tray
- Anti-splash insert
- Perforated baking tray
- Round baking tray
- Round perforated baking tray

# Using for the first time

## Before using for the first time

 The oven must not be operated until it has been correctly installed in its housing unit.

- Press and release the function and temperature selectors if they are retracted.

The time of day can only be changed when the function selector is at **0**.

- Set the time of day.

## Setting the time of day for the first time

The time of day is shown in 24 hour clock format.



After connecting the oven to the electricity supply, *12:00* will flash on the display.

The time of day is set in segments: first the hours, then the minutes.

- Confirm with *OK*.

*12:00* will light up and  will flash.

- While the  symbol is flashing, confirm with *OK*.

The hours will flash.

- Use *<* or *>* to set the hours.
- Confirm with *OK*.

The hours are saved and the minutes will flash.

- Use *<* or *>* to set the minutes.
- Confirm with *OK*.

The time of day is now saved.

The time of day can be displayed in 12 hour format by setting *P 2* in the settings menu to status *12* (see "Clock/timer – Changing settings").

### Heating up the oven for the first time

New ovens can give off an unpleasant smell on first use. Heating up the oven for at least 1 hour with nothing in it will get rid of this smell.

Ensure that the kitchen is well ventilated during this operation. Close doors to other rooms to prevent the smell spreading throughout the house.

- Remove any stickers or protective foil from the oven and accessories.
- Take the accessories out of the oven and clean them (see "Cleaning and care").
- Before heating the oven up, wipe the interior with a damp cloth to remove any dust or bits of packaging that may have accumulated in the oven cavity during storage and unpacking.
- Select Fan plus .

The oven heating, lighting and cooling fan will switch on.

- Set the maximum temperature (250 °C).
- Heat the empty oven for at least an hour.
- After the heating up process has finished, turn the function selector to **0** and the temperature selector to **•**.

 Danger of burning. Allow the oven to cool down before cleaning by hand.





- Clean the oven interior with a clean sponge and a solution of hot water and washing-up liquid or a damp microfibre cloth.
- Dry all surfaces with a soft cloth.

Leave the oven door open until the oven interior is completely dry.

# Overview of functions







---

Your oven has a range of oven functions for preparing food.

Function	Description
<b>Conventional heat</b> 	For baking and roasting traditional recipes, cooking soufflés and cooking at low temperatures. If using an older recipe or cookbook, set the oven temperature for Conventional heat 10 °C lower than that recommended. This will not change cooking times.
<b>Bottom heat</b> 	Use this setting towards the end of cooking to brown the base of a cake, quiche or pizza.
<b>Grill</b> 	For grilling thin cuts (e.g. steak) and browning baked dishes.
<b>Rapid heat-up</b> 	For pre-heating the oven quickly. The oven function required must then be selected.







## Overview of functions

Function	Description
<b>Fan plus</b> 	This function is used for baking and roasting on different levels at the same time. A lower temperature can be selected than when using Conventional heat  , as the fan distributes the heat around the oven compartment straight away.
<b>Intensive bake</b> 	For baking cakes with moist toppings. Intensive bake is not suitable for baking thin biscuits or for roasting as the juices will become too dark.
<b>Fan grill</b> 	For grilling thicker cuts of meat (e.g. chicken). Lower temperatures can be used than when using the Grill  function, as the fan distributes the heat around the oven compartment straight away.
<b>Gentle bake</b> 	For small amounts e.g. of frozen pizza, bake-off rolls, cookies and for meat dishes and roasts. You can save up to 30 % energy compared to cooking with a standard oven function as long as the door is kept shut during cooking.

# Tips on saving energy

---

## Cooking

- Remove any accessories from the oven that you do not require for cooking.
- Pre-heat the oven only if instructed to do so in the recipe or the cooking chart.
- Avoid opening the door during cooking.
- In general, if a range of temperatures is given, it is best to select the lower temperature and to check the food after the shortest given time.
- It is best to use dark baking tins and containers with a matt finish made from non-reflective materials (enamelled steel, oven-proof glassware, non-stick coated cast aluminium). Shiny materials such as stainless steel or aluminium reflect heat, preventing it reaching the food efficiently. Do not cover the oven floor or the rack with heat-reflective aluminium foil.
- Observe cooking durations to avoid energy wastage when cooking food.
- Wherever possible set the cooking duration, or use a food probe.
- Fan plus  can be used for cooking many types of food. Because the fan distributes the heat to food straight away, it allows you to use a lower temperature than you would with Conventional heat . It also enables you to cook on several shelf levels at the same time.
- Gentle bake  is an innovative function that makes optimum use of heat. You can save up to 30 % energy compared to cooking with a standard oven function as long as the door is kept shut during cooking.
- Fan grill  can be used for a wide variety of food. With Fan grill you can use lower temperatures than with other grill functions which use the maximum temperature setting.
- Whenever possible you should cook several dishes at the same time. Place them next to each other in the oven or on different shelf levels.
- Dishes which you are unable to cook at the same time should, if possible, be cooked one after the other in order to make use of existing heat in the oven.

### Using residual heat

- The temperature in cooking programmes using temperatures above 140 °C which take longer than 30 minutes to cook can be turned down to the lowest possible temperature about 5 minutes before the end of cooking. The residual heat in the oven is sufficient for cooking the food. Do not switch the oven off (see "Warning and safety instructions").
- If you wish to run the pyrolytic cleaning programme, it is best to start it immediately after a cooking programme. The residual heat in the oven will help reduce the amount of energy required to run the programme.

# Using the oven

---

## Simple operation

- Place the food in the oven.
- Select the required oven function with the function selector.

The oven lighting and the fan will switch on.

- Use the temperature selector to set the temperature.

The oven heating will switch on.

After cooking:

- Turn the function selector to **0** and the temperature selector to **•**.
- Take the food out of the oven.

## Cooling fan

The cooling fan will continue to run for a while after the oven has been switched off to prevent any humidity building up in the oven, on the control panel or in the oven housing unit.

This cooling fan will switch itself off automatically after a certain period of time.

## Pre-heating the oven

It is only necessary to pre-heat the oven in a few instances.

Most dishes can be placed in a cold oven. They will then make use of the heat produced during the heating-up phase.

Pre-heat the oven when cooking the following food with the following oven functions:

### Fan plus

- dark bread dough
- beef sirloin joints and fillet



### Conventional heat

- cakes and biscuits with a short baking time (up to 30 minutes)
- delicate mixtures (e.g. sponges)
- dark bread dough
- beef sirloin joints and fillet

## Rapid heat-up

With Rapid heat-up  the heating up phase can be shortened.

Do not use Rapid heat-up  to pre-heat the oven when baking pizzas or biscuits and small cakes. They will brown too quickly on top.

- Select Rapid heat-up .
- Select a temperature.
- When the temperature indicator light  goes out for the first time, set the oven function you require for continued cooking.
- Place the food in the oven.

# Clock/timer

The clock/timer offers the following functions:

- Time of day display
- Minute minder
- Switching cooking processes on and off automatically
- Altering settings *P*

The clock/timer is operated via the **display** and the **sensor controls** <, *OK* and >.

The functions available are indicated by symbols.

## Display

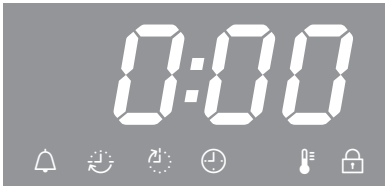

### Symbols on the display

Depending on the position of the function selector  $\odot$  and/or whether a sensor has been pressed, the following symbols appear:

Symbol/function	$\odot$
Minute minder	Any
Duration	Function
End of cooking duration	
Temperature indicator light	
Clock display	0
<i>P</i> Setting	
5 Setting status	
System lock	

You can only set or change a function if the function selector is in the correct position.

## Sensors

Sensor	Use
<	<ul style="list-style-type: none"> <li>- Highlight functions</li> <li>- Reduce duration</li> <li>- Access settings <i>P</i></li> <li>- Change the status 5 of a setting <i>P</i></li> </ul>
>	<ul style="list-style-type: none"> <li>- Highlight functions</li> <li>- Increase duration</li> <li>- Change the status 5 of a setting <i>P</i></li> </ul>
<i>OK</i>	<ul style="list-style-type: none"> <li>- Access functions</li> <li>- Saving set durations and changed settings</li> <li>- Access set durations</li> </ul>

Set minutes or seconds with < or > in increments of 1.

If you hold the button down the display will count down faster.

## Setting the time

The time of day is set in segments:

- for the time of day and cooking durations, first the hours, then the minutes,
- for a minute minder duration, first the minutes, then the seconds.

■ Confirm with *OK*.

The respective functions appear depending on the position of the function selector (⏰, ⏱, ⏲ or ⏳).

■ Highlight the function you want using < or >.

The appropriate symbol will flash for approx. 15 seconds.

■ While the symbol is flashing, confirm with *OK*.

The function is accessed and the left-hand numeric block will flash.

You can only set the time while the numeric block is flashing. If the time has elapsed and the numeric block is no longer flashing, you have to access the function again.

■ Use < or > to set the time you want.

■ Confirm with *OK*.

The right-hand numeric block will flash.

■ Use < or > to set the time you want.

■ Confirm with *OK*.

The time has now been saved.

## Time display

The symbols ⏰ and ⏱ or ⏲ will show if you have set times.

If you are using the minute minder ⏰, cooking duration ⏱ and end of cooking duration ⏲ functions at the same time, the last time that you set will be shown.

If you have set a cooking duration, the time of day will not be displayed.

## At the end of the duration

When a duration has elapsed, the appropriate symbol will flash and a buzzer will sound if the buzzer is switched on (see "Clock/timer - Changing settings").

■ Confirm with *OK*.

The buzzer will stop and the symbols in the display will go out.

## Clock/timer

### Using the minute minder

The minute minder can be used to time other activities in the kitchen, e.g. boiling eggs.

The minute minder can also be used at the same time as a cooking programme in which the start and finish times have been set, e.g. as a reminder to stir a dish or add seasoning etc.

A maximum minute minder time of 99 minutes and 59 seconds can be set.

### To set the minute minder

Example: You want to boil some eggs and set a minute minder duration of 6 minutes and 20 seconds.



- Press < continuously until  flashes.
- Confirm with OK.



00:00 will appear and the minutes will start to flash.

If you press < once, two dashes will appear and then when you press again the maximum possible minutes will appear in the minute numeric block 99.



- Use < or > to set the minutes.
- Confirm with OK.

The minutes are saved and the seconds will flash.



- Use < or > to set the seconds.
- Confirm with OK.



The minute minder duration is now saved and will count down in seconds.

The  symbol indicates the minute minder duration.



## At the end of the minute minder duration:

- 🔔 flashes.
- The display will show the time counting upwards.
- For approx. 7 minutes, a buzzer will sound if switched on (see "Clock/timer - Changing settings").

- Confirm with *OK*.

The buzzer will stop and the symbols in the display will go out.

If no cooking durations have been set, the time of day appears in the display.

## To change the minute minder duration

- Press < continuously until 🔔 flashes.

The minute minder duration selected will appear.

- Confirm with *OK*.

The minutes will flash.

- Use < or > to set the minutes.

- Confirm with *OK*.

The seconds will flash.

- Use < or > to set the seconds.

- Confirm with *OK*.

The changed minute minder duration is now saved and will count down in seconds.

## To delete the minute minder duration

- Press < continuously until 🔔 flashes.
- Confirm with *OK*.

The minutes will flash.

- Reduce the minutes down to *00* using < or increase them up to *99* using >.

The next time the sensor is pressed two dashes will appear in place of the minutes.



- Confirm with *OK*.

Four dashes appear:



- Confirm with *OK*.

The minute minder duration is now cancelled.

If no cooking durations have been set, the time of day appears in the display.

# Clock/timer

## Switching on and off automatically

Cooking programmes can be switched off, or on and off automatically.

To do this, set a duration or a duration and finish time after selecting an oven function and a temperature.

The maximum duration which can be set for a cooking programme is 11 hours and 59 minutes.

We recommend switching on and off automatically when roasting. If using it for baking, do not delay the start for too long as the cake mixture or dough will dry out, and the raising agents will lose their effectiveness.

## Setting a cooking duration

Example: a cake needs to bake for 1 hour and 5 minutes.

- Place the food in the oven.
- Select the required oven function and the temperature.

The oven heating, lighting and cooling fan will switch on.

- Press > continuously until 🕒 flashes.

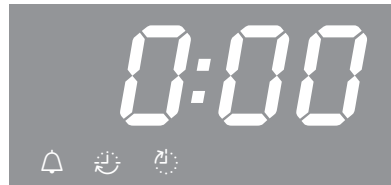

0:00 will appear.

- Confirm with OK.

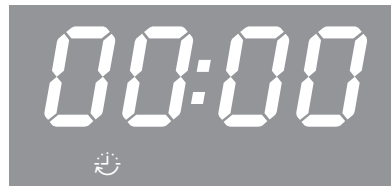

00:00 will appear and the hour numeric block will start to flash.

If you press < once, two dashes will appear and then when you press again the maximum possible hours will appear in the hour numeric block //.



- Use < or > to set the hours.
- Confirm with OK.

The hours are saved and the minutes will flash.

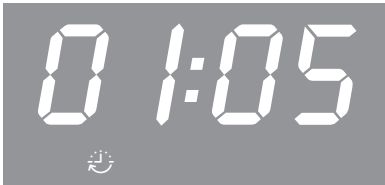

- Use < or > to set the minutes.
- Confirm with OK.

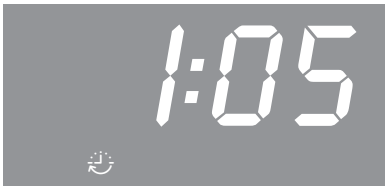

The cooking duration is now saved and will count down in minutes until the last minute, which will count down in seconds.

The 🕒 symbol indicates the cooking duration.

### At the end of the cooking duration:

- 0:00 will appear.
- 🕒 will flash.
- The oven heating will switch off automatically.
- The cooling fan continues to run.
- For approx. 7 minutes, a buzzer will sound if switched on (see "Clock/timer - Changing settings").
- Confirm with OK.
- The buzzer will stop and the symbols in the display will go out.
- The time of day appears.
- The oven heating will then switch on again.
- Turn the function selector to 0 and the temperature selector to •.
- Take the food out of the oven.

## Clock/timer

### Setting a cooking duration and end of cooking duration

To switch a cooking process on and off automatically you can set a cooking duration and an end of cooking duration.

Example: the current time of day is 11:15; a roast with a cooking duration of 90 minutes needs to be ready at 13:30.

- Place the food in the oven.
- Select the required oven function and the temperature.

The oven heating, lighting and cooling fan will switch on.

#### First set the cooking duration:

- Press > continuously until  flashes.
- Confirm with OK.

00:00 will appear and the hour numeric block will start to flash.

- Use < or > to set the hours.
- Confirm with OK.

The hours are saved and the minutes will flash.

- Use < or > to set the minutes.
- Confirm with OK.

The cooking duration is now saved.

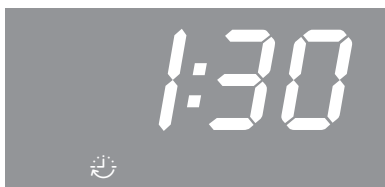

The  symbol indicates the cooking duration.

#### Then set the end of cooking duration:

- Press > continuously until  flashes.



12:45 (= current time of day + cooking duration = 11:15 + 1:30) appears in the display.

- Confirm with OK.

The hours will flash.



- Use < or > to set the hours.
- Confirm with OK.

The hours are saved and the minutes will flash.



- Use < or > to set the minutes.
- Confirm with OK.

The end of cooking duration  is now saved.

The oven heating, lighting and cooling fan will switch off.

The end of cooking duration set will then appear in the display.

As soon as the start time ( $13:30 - 1:30 = 12:00$ ) has been reached, the oven heating, lighting and cooling fan will switch on.

The cooking duration set  appears and will count down in minutes until the last minute, which will count down in seconds.

## Changing the cooking duration

- Press > continuously until  flashes.

The time remaining will appear in the display.

- Confirm with OK.

The hours will flash.

- Use < or > to set the hours.

- Confirm with OK.

The minutes will flash.

- Use < or > to set the minutes.

- Confirm with OK.

The changed cooking duration is now saved.

# Clock/timer

## Deleting a cooking duration

- Press < or > continuously until  flashes.

- Confirm with *OK*.

The hours will flash.

- Press < or > continuously until two dashes appear:

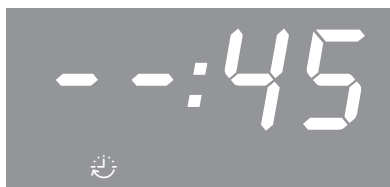

- Confirm with *OK*.

Four dashes appear:

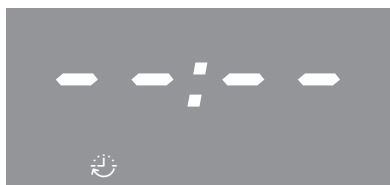

- Confirm with *OK*.

The cooking duration and any end of cooking duration set will be deleted.

The time of day appears when no minute minder duration is set.

The oven heating, lighting and cooling fan will switch on.

If you want to end the cooking process:

- Turn the function selector to **0** and the temperature selector to **•**.

- Take the food out of the oven.

## Deleting the end of cooking duration

- Press < or > continuously until  flashes.

- Confirm with *OK*.

The hours will flash.

- Press < or > continuously until two dashes appear.

- Confirm with *OK*.

Four dashes appear.

- Confirm with *OK*.

The  symbol appears and the cooking duration set will count down in minutes until the last minute, which will count down in seconds.

If you want to end the cooking process:

- Turn the function selector to **0** and the temperature selector to **•**.

- Take the food out of the oven.

If the function selector is turned to the **0** position, the settings for cooking duration and end of cooking duration will be deleted.

## Changing the time of day

The time of day can only be changed when the function selector is at **0**.

- Turn the function selector to **0**.
- Press **>** continuously until **⊕** flashes.
- Confirm with **OK**.

The hours will flash.

- Use **<** or **>** to set the hours.
- Confirm with **OK**.

The hours are saved and the minutes will flash.

- Use **<** or **>** to set the minutes.
- Confirm with **OK**.

The time of day is now saved.

The time of day must be reset following an interruption to the power supply.

# Clock/timer

## Changing settings

Default settings are set in the oven controls at the factory (see "Settings overview").

You change a setting *P* by changing its status *S*.

- Turn the function selector to **0**.
- Press < continuously until *P* flashes:



- If you want to change another setting, press < or > continuously until the relevant digit appears.
- Confirm with **OK**.



The setting is applied and the current status *S* appears, e.g. *0*

To change the status:

- Press < or > continuously until the status you want is shown.
- Confirm with **OK**.

The selected status is now saved and the setting *P* appears again.

To change further settings, proceed in the same way.

If you do not want to change further settings:

- Wait approx. 15 seconds until the time of day appears.

The settings are retained in the event of an interruption to the power supply.



## Settings overview

Setting	Status
<i>P 1</i> <b>Buzzer volume</b>	<p>5 0 The buzzer is <b>switched off</b>.</p> <p>5 1 to 5 30* The buzzer is <b>switched on</b>. The volume can be altered. When you select a status you will hear the corresponding buzzer.</p>
<i>P 2</i> <b>Clock format</b>	<p>24* The time of day is shown in <b>24 hour format</b>.</p> <p>12 The time of day is shown in <b>12 hour format</b>. If you change the clock after 13:00 from a 12 hour clock to a 24 hour clock you will need to update the hour accordingly.</p>
<i>P 3</i> <b>System lock for the oven</b>	<p>5 0* The system lock is <b>switched off</b>.</p> <p>5 1 The system lock is <b>On</b> and  appears in the display. The system lock prevents the oven from being used inadvertently. The system lock will remain turned on in the case of a power failure.</p>
<i>P 4</i> <b>Keypad tone</b>	<p>5 0 Keypad tone <b>deactivated</b>.</p> <p>5 1* Keypad tone <b>activated</b>.</p>



\* Factory default setting

# Baking

Eating food which has been cooked correctly is important for good health.



Only bake cakes, pizza, chips etc. until they are golden. Do not over-cook them.

## Functions

Depending on how the food is prepared, you can use Fan plus , Intensive bake  or Conventional heat .

## Bakeware

The choice of bakeware depends on the oven function.

- Fan plus , Intensive bake : baking tray, universal tray, bakeware of any oven-proof material.
- Conventional heat : Dark baking tins with a matt finish. Avoid using bright, shiny metal tins as they give an uneven and poor browning result and in some cases cakes might not cook properly.
- Always place baking tins on the rack. Position rectangular tins with the longer side across the width of the rack for optimum heat distribution and even baking results.
- When baking cakes with fresh fruit toppings and deep sponge cakes place the tin in the universal tray to catch any spillages.

## Baking paper, greasing the tin

Miele accessories, e.g. the universal tray are treated with PerfectClean enamel (see "Features").

Surfaces treated with PerfectClean enamel generally do not need to be greased or covered with baking paper.

Baking paper should be used with:

- anything prepared using a lye containing sodium hydroxide (e.g. pretzels, bread sticks) because the lye can damage the PerfectClean surface,
- meringues or sponges with a high egg-white content because they are more likely to stick,
- frozen food cooked on the rack.

## Notes on using the baking charts

The data for the recommended function is printed in bold.

Unless otherwise stated, the durations given are for an oven which has not been pre-heated. With a pre-heated oven, shorten durations by up to 10 minutes.

### Temperature

As a general rule, select the lower temperature given in the chart.

Baking at temperatures higher than those recommended may reduce the cooking time, but will lead to uneven browning, and unsatisfactory cooking results.

### Duration

Check if the food is cooked at the end of the shortest time quoted. To check if a cake is ready, insert a wooden skewer into the centre. It is ready if the skewer comes out clean, without dough or crumbs sticking to it.



### Shelf level <sup>5</sup><sub>1</sub>

The shelf level on which you place your food for baking depends on the oven function and number of trays being used.

- **Fan plus**   
1 tray: level 2  
2 trays: levels 1+3/2+4  
3 trays: levels 1+3+5

When using the universal tray and baking tray to bake on two or more levels at the same time, place the universal tray underneath the baking tray.

















Bake moist biscuits and cakes on a maximum of two levels at the same time.

- **Intensive bake**   
1 tray: level 1 or 2
- **Conventional heat**   
1 tray: level 1 or 2



# Baking

## Baking charts

### Creamed mixture

Cakes / biscuits		 [°C]	 <sup>5</sup> <sub>1</sub>	 [min]
Muffins (1 tray)		<b>140-150</b>	<b>2<sup>2)</sup></b>	<b>35-45</b>
		150-160	2 <sup>2)</sup>	30-40
Muffins (2 trays)		<b>140-150</b>	<b>2+4<sup>2)</sup></b>	<b>35-45<sup>3)</sup></b>
Small cakes (1 tray) *		<b>150</b>	<b>2</b>	<b>30-40</b>
		<b>160<sup>1)</sup></b>	<b>3</b>	<b>20-30</b>
Small cakes (2 trays) *		<b>150<sup>1)</sup></b>	<b>2+4</b>	<b>23-33</b>
Small cakes/biscuits (1 tray)		<b>140-150</b>	<b>2<sup>2)</sup></b>	<b>25-35</b>
		150-160 <sup>1)</sup>	3 <sup>2)</sup>	15-25
Small cakes/biscuits (2 trays)		<b>140-150</b>	<b>2+4<sup>2)</sup></b>	<b>25-35<sup>3)</sup></b>
Sponge cake		150-160	2 <sup>2)</sup>	60-70
		<b>150-160<sup>1)</sup></b>	<b>2<sup>2)</sup></b>	<b>60-70</b>
Ring cake		<b>150-160</b>	<b>2<sup>2)</sup></b>	<b>50-60</b>
		170-180	2 <sup>2)</sup>	55-65

 Function /  Fan plus /  Conventional heat

















 Temperature / <sup>5</sup><sub>1</sub> Shelf level /  Duration

\* The settings also apply for testing in accordance with EN 60350-1.



Do not use the FlexiClip telescopic runners (depending on model).

- 1) Pre-heat the oven. Do not use the Rapid heat-up function  for this.
- 2) If you are using FlexiClip telescopic runners (depending on model), fit them one level lower.
- 3) Take the baking trays out of the oven early if the food is sufficiently browned before the specified duration has elapsed.

## Creamed mixture

Cakes / biscuits		 [°C]	 <sup>5</sup> <sub>1</sub>	 [min]
Foam cake (tray)		<b>150-160</b>	<b>2</b> <sup>2)</sup>	<b>25-35</b>
		150-160 <sup>1)</sup>	2 <sup>2)</sup>	30-40
Marble, nut cake (tin)		<b>150-160</b>	<b>2</b> <sup>2)</sup>	<b>55-75</b>
		150-160	2 <sup>2)</sup>	55-75
Fresh fruit cake, with meringue topping (tray)		150-160	2 <sup>2)</sup>	40-50
		<b>170-180</b>	<b>2</b> <sup>2)</sup>	<b>45-55</b>
Fresh fruit cake (tray)		<b>150-160</b>	<b>2</b> <sup>2)</sup>	<b>35-45</b>
		160-170	2 <sup>2)</sup>	35-55
Fresh fruit cake (tin)		150-160	2 <sup>2)</sup>	55-65
		<b>170-180</b> <sup>1)</sup>	<b>1</b>	<b>35-45</b>
Flan base		<b>150-160</b>	<b>2</b> <sup>2)</sup>	<b>25-35</b>
		170-180 <sup>1)</sup>	2 <sup>2)</sup>	15-25

 Function /  Fan plus /  Conventional heat

















 Temperature / <sup>5</sup><sub>1</sub> Shelf level /  Duration

1) Pre-heat the oven. Do not use the Rapid heat-up function  for this.



2) If you are using FlexiClip telescopic runners (depending on model), fit them one level lower.

# Baking

## Rubbed in mixture

<b>Cakes / biscuits</b>		 [°C]	 <sup>5</sup> <sub>1</sub>	 [min]
Small cakes/biscuits (1 tray)		<b>140-150</b>	<b>2</b> <sup>2)</sup>	<b>20-30</b>
		160-170 <sup>1)</sup>	3 <sup>2)</sup>	15-25
Small cakes/biscuits (2 trays)		<b>140-150</b>	<b>1+3</b> <sup>2)</sup>	<b>20-30</b> <sup>3)</sup>
Drop cookies (1 tray) *		<b>140</b>	<b>2</b>	<b>35-45</b>
		<b>160</b> <sup>1)</sup>	<b>3</b>	<b>20-30</b>
Drop cookies (2 trays) *		<b>140</b>	<b>1+3</b>	<b>35-45</b> <sup>3)</sup>
Flan base		<b>150-160</b>	<b>2</b> <sup>2)</sup>	<b>35-45</b>
		170-180 <sup>1)</sup>	2	20-30
Streusel cake		<b>150-160</b>	<b>2</b> <sup>2)</sup>	<b>45-55</b>
		170-180	2 <sup>2)</sup>	45-55
Cheese cake		150-160	2 <sup>2)</sup>	85-95
		<b>170-180</b>	<b>2</b> <sup>2)</sup>	<b>80-90</b>
		150-160	2 <sup>2)</sup>	80-90

 Function /  Fan plus /  Conventional heat /  Intensive bake















 Temperature / <sup>5</sup><sub>1</sub> Shelf level /  Duration

\* The settings also apply for testing in accordance with EN 60350-1.



Do not use the FlexiClip telescopic runners (depending on model).

- 1) Pre-heat the oven. Do not use the Rapid heat-up function  for this.
- 2) If you are using FlexiClip telescopic runners (depending on model), fit them one level lower.
- 3) Take the baking trays out of the oven early if the food is sufficiently browned before the specified duration has elapsed.

## Rubbed in mixture

Cakes / biscuits		 [°C]	 <sup>5</sup> <sub>1</sub>	 [min]
Apple cake (Apple pie) (baking tin Ø 20 cm) *		<b>160</b>	<b>2</b>	<b>90–100</b>
		<b>180</b>	<b>1</b>	<b>90–100</b>
Apple pie		160–170	2 <sup>2)</sup>	50–70
		<b>170–180</b> <sup>1)</sup>	<b>2</b> <sup>2)</sup>	<b>60–70</b>
		<b>160–170</b>	<b>2</b> <sup>2)</sup>	<b>50–70</b>
Fresh fruit tart, glazed (tin)		150–160	2 <sup>2)</sup>	55–75
		170–180	2 <sup>2)</sup>	55–75
		<b>150–160</b>	<b>2</b> <sup>2)</sup>	<b>55–65</b>
Swiss apple pie (tray)		<b>220–230</b> <sup>1)</sup>	<b>1</b>	<b>30–50</b>
		<b>180–190</b>	<b>1</b>	<b>30–50</b>

 Function /  Fan plus /  Conventional heat /  Intensive bake















 Temperature / <sup>5</sup><sub>1</sub> Shelf level /  Duration



\* The settings also apply for testing in accordance with EN 60350-1.  
Do not use the FlexiClip telescopic runners (depending on model).



- 1) Pre-heat the oven. Do not use the Rapid heat-up function  for this.
- 2) If you are using FlexiClip telescopic runners (depending on model), fit them one level lower.

# Baking

## Yeast mixtures and quark dough

Cakes / biscuits		 [°C]	 <sup>5</sup> <sub>1</sub>	 [min]
Gugelhupf		<b>150-160</b>	<b>2</b> <sup>1)</sup>	<b>50-60</b>
		160-170	1	50-60
Stollen		<b>150-160</b>	<b>2</b> <sup>1)</sup>	<b>45-65</b>
		160-170	2 <sup>1)</sup>	45-60
Streusel cake		150-160	2 <sup>1)</sup>	35-45
		<b>170-180</b>	<b>3</b> <sup>1)</sup>	<b>35-45</b>
Fresh fruit cake (tray)		160-170	2 <sup>1)</sup>	40-50
		<b>170-180</b>	<b>3</b> <sup>1)</sup>	<b>50-60</b>
Apple turnovers (1 tray)		150-160	2 <sup>1)</sup>	25-30
		<b>160-170</b>	<b>2</b> <sup>1) 2)</sup>	<b>25-30</b>
Apple turnovers (2 trays)		150-160	1+3 <sup>1)</sup>	25-30 <sup>3)</sup>

















 Function /  Fan plus /  Conventional heat

 Temperature /  Shelf level /  Duration



- 1) If you are using FlexiClip telescopic runners (depending on model), fit them one level lower.
- 2) For yeast dough. For quark dough use shelf level 3.
- 3) Take the baking trays out of the oven early if the food is sufficiently browned before the specified duration has elapsed.





## Yeast mixtures and quark dough

Cakes / biscuits		 [°C]	 <sup>5</sup> <sub>1</sub>	 [min]
White bread		180-190	2 <sup>2)</sup>	35-45
		<b>190-200</b>	<b>2<sup>2)</sup></b>	<b>30-40</b>
Wholegrain bread		180-190	2 <sup>2)</sup>	55-65
		<b>200-210<sup>1)</sup></b>	<b>2<sup>2)</sup></b>	<b>45-55</b>
Pizza (tray)		170-180	2 <sup>2)</sup>	30-45
		<b>190-200<sup>1)</sup></b>	<b>2<sup>2) 3)</sup></b>	<b>30-45</b>
		<b>170-180</b>	<b>2<sup>2) 3)</sup></b>	<b>30-45</b>
Onion tart		170-180	2 <sup>2)</sup>	30-40
		<b>180-190<sup>1)</sup></b>	<b>2<sup>2) 3)</sup></b>	<b>25-35</b>
		<b>170-180</b>	<b>2<sup>2)</sup></b>	<b>30-40</b>
Proving dough		50	4)	15-30
		<b>50</b>	4)	<b>15-30</b>













 Function /  Fan plus /  Conventional heat /  Intensive bake

 Temperature / <sup>5</sup><sub>1</sub> Shelf level /  Duration



- 1) Pre-heat the oven. Do not use the Rapid heat-up function  for this.
- 2) If you are using FlexiClip telescopic runners (depending on model), fit them one level lower.
- 3) For yeast dough. For quark dough use shelf level 3.
- 4) The dish can be placed on the oven floor. Depending on the size of the dish, you may need to remove the shelf runners. If using Conventional heat , please also place the rack on the oven floor.

# Baking

## Whisked mixture

Cakes / biscuits		 [°C]	 <sup>5</sup> <sub>1</sub>	 [min]
Tart / flan base (2 eggs)		160-170	2 <sup>2)</sup>	20-30
		<b>160-170</b> <sup>1)</sup>	<b>2</b> <sup>2)</sup>	<b>15-25</b>
Sponge cake (4-6 eggs)		170-180	2 <sup>2)</sup>	20-35
		<b>150-160</b> <sup>1)</sup>	<b>2</b> <sup>2)</sup>	<b>30-45</b>
Whisked sponge *		<b>180</b> <sup>1)</sup>	<b>2</b>	<b>20-30</b>
		<b>150-170</b> <sup>1)</sup>	<b>2</b>	<b>30-45</b>
Swiss roll		170-180 <sup>1)</sup>	2 <sup>2)</sup>	15-20
		<b>180-190</b> <sup>1)</sup>	<b>2</b> <sup>2)</sup>	<b>15-20</b>

 Function /  Fan plus /  Conventional heat













 Temperature /  <sup>5</sup><sub>1</sub> Shelf level /  Duration



\* The settings also apply for testing in accordance with EN 60350-1.  
Do not use the FlexiClip telescopic runners (depending on model).



1) Pre-heat the oven. Do not use the Rapid heat-up function  for this.

2) If you are using FlexiClip telescopic runners (depending on model), fit them one level lower.

## Choux pastry, puff pastry, meringue

Cakes / biscuits		 [°C]	 <sup>5</sup> <sub>1</sub>	 [min]
Choux buns (1 tray)		<b>160–170</b>	<b>2</b> <sup>2)</sup>	<b>30–45</b>
		180–190 <sup>1)</sup>	3 <sup>2)</sup>	25–35
Choux buns (2 trays)		<b>160–170</b>	<b>1+3</b> <sup>2)</sup>	<b>30–45</b> <sup>3)</sup>
Puff pastry (1 tray)		<b>170–180</b>	<b>2</b> <sup>2)</sup>	<b>20–30</b>
		190–200	3 <sup>2)</sup>	20–30
Puff pastry (2 trays)		<b>170–180</b>	<b>1+3</b> <sup>2)</sup>	<b>20–30</b> <sup>3)</sup>
Macaroons (1 tray)		<b>120–130</b>	<b>2</b> <sup>2)</sup>	<b>25–50</b>
		120–130 <sup>1)</sup>	3 <sup>2)</sup>	25–45
Macaroons (2 trays)		<b>120–130</b>	<b>1+3</b> <sup>2)</sup>	<b>25–50</b> <sup>3)</sup>

 Function /  Fan plus /  Conventional heat



 Temperature / <sup>5</sup><sub>1</sub> Shelf level /  Duration

- 1) Pre-heat the oven. Do not use the Rapid heat-up function  for this.
- 2) If you are using FlexiClip telescopic runners (depending on model), fit them one level lower.
- 3) Take the baking trays out of the oven early if the food is sufficiently browned before the specified duration has elapsed.

# Roasting

---

## Functions

Depending on how the food is prepared, you can use Fan plus  or Conventional heat .

## Dishes

You can use any heat-resistant dishes:

Miele Gourmet oven dishes, roasting pans, ovenproof glass dishes, roasting bags, dishes made from earthenware or cast iron, the universal tray, rack and/or anti-splash insert (if available) on top of the universal tray.

We recommend roasting in oven dishes as this ensures that sufficient stock remains for making gravy. The oven also stays cleaner than when roasting on the rack.

## Tips

- Browning only occurs towards the end of the roasting time. Remove the lid about halfway through the roasting time if a more intensive browning result is desired.
- At the end of the programme, take the roast out of the oven, wrap in aluminium foil and leave to stand for about 10 minutes. This helps retain juices when the meat is carved.
- For a crisp finish, baste poultry 10 minutes before the end of the cooking time with slightly salted water.



## Notes on using the roasting charts

The data for the recommended function is printed in bold.

Unless otherwise stated, the durations given are for an oven which has not been pre-heated. With a pre-heated oven, shorten durations by up to 10 minutes.

### Temperature

As a general rule, select the lower temperature given in the chart. If higher temperatures are used, the meat will brown on the outside, but will not be properly cooked through.

When cooking with Fan plus , select a temperature of 20 °C lower than for Conventional Heat .

For cuts which weigh more than 3 kg, select a temperature approx. 10 °C lower than that given in the roasting chart.

Roasting will take longer at the lower temperature, but will be more even.

When roasting on the rack, set a temperature approx. 10 °C lower than for roasting in an oven dish.

## Pre-heating

Pre-heating is generally only required when roasting beef sirloin joints and fillet.

## Roasting duration

The traditional British method for calculating the roasting time is to allow 15 to 20 minutes per lb/450 grammes, according to type of meat, plus approx. 20 minutes, adjusting the length of time as roasting proceeds to obtain the required result. The roasting time can also be determined by multiplying the thickness of the roast [cm] with the time per cm [min/cm], depending on the type of meat:

- Beef/venison: 15–18 min/cm
- Pork/veal/lamb: 12–15 min/cm
- Sirloin/fillet: 8–10 min/cm

Check if the meat is cooked after the shortest duration quoted.

## Shelf level













As a general rule, use shelf level 2.





If you are using FlexiClip telescopic runners (depending on model), fit them one level lower.

# Roasting

## Roasting charts

### Beef, veal

		 [°C]	 <sup>5</sup> <sub>1</sub> *	 [min]
Topside of beef, approx. 1 kg		170–180	2	100–130 <sup>3)</sup>
		<b>190–200</b>	<b>2</b>	<b>110–140</b> <sup>3)</sup>
Fillet of beef approx. 1 kg <sup>1)</sup>		150–160 <sup>2)</sup>	2	20–50 <sup>4)</sup>
		<b>180–190</b> <sup>2)</sup>	<b>2</b>	<b>20–50</b> <sup>4)</sup>
Sirloin joint, approx. 1 kg <sup>1)</sup>		150–160 <sup>2)</sup>	2	30–60 <sup>4)</sup>
		<b>180–190</b> <sup>2)</sup>	<b>2</b>	<b>30–60</b> <sup>4)</sup>
Veal, approx. 1.5 kg		<b>190–200</b>	<b>2</b>	<b>70–90</b> <sup>3)</sup>
		200–210	2	90–110 <sup>3)</sup>













 Function /  Temperature /  <sup>5</sup> <sub>1</sub> Shelf level /  Cooking duration





 Fan plus /  Conventional heat

\* If you are using FlexiClip telescopic runners (depending on model), fit them one level lower.

- 1) Use the universal tray. Sear the meat on the hob first.
- 2) Pre-heat the oven. Do not use the Rapid heat-up function  for this.
- 3) Roast with the lid on first. Then remove the lid three-quarters of the way through roasting and add approx. 0.5 litre liquid.
- 4) Depending on desired degree of cooking (when using a separate cooking thermometer): rare: 40–45 °C, medium: 50–60 °C, well done: 60–70 °C

## Pork

		 [°C]	 <sup>5</sup> / <sub>1</sub> *	 [min]
Pork joint, approx. 1 kg		170–180	2	100–120 <sup>1)</sup>
		<b>190–200</b>	<b>2</b>	<b>90–110</b> <sup>1)</sup>
Pork joint with crackling, approx. 2 kg		170–180	2	120–160 <sup>2)</sup>
		190–200	2	130–150 <sup>2)</sup>
Gammon joint, approx. 1 kg		150–160	2	60–80 <sup>2)</sup>
		170–180	2	80–100 <sup>2)</sup>
Meat loaf, approx. 1 kg		170–180	2	60–70 <sup>2)</sup>
		<b>200–210</b>	<b>2</b>	<b>70–80</b> <sup>2)</sup>

 Function /  Temperature /  <sup>5</sup>/<sub>1</sub> Shelf level /  Cooking duration











 Fan plus /  Conventional heat





\* If you are using FlexiClip telescopic runners (depending on model), fit them one level lower.

- 1) Roast with the lid on first. Remove the lid halfway through the cooking duration and add approx. 0.5 litre of liquid.
- 2) Add approx. 0.5 litre liquid halfway through roasting.

# Roasting

## Lamb, game

		 [°C]	 <sup>5</sup> <sub>1</sub> *	 [min]
Leg of lamb, approx. 1.5 kg		170–180	2	90–110 <sup>1)</sup>
		<b>180–190</b>	<b>2</b>	<b>90–110</b> <sup>1)</sup>
Saddle of lamb, approx. 1.5 kg		220–230 <sup>2)</sup>	3	40–60 <sup>3)</sup>
		<b>230–240</b> <sup>2)</sup>	<b>3</b>	<b>40–60</b> <sup>3)</sup>
Venison, approx. 1 kg		<b>200–210</b>	<b>2</b>	<b>80–100</b> <sup>1)</sup>
		200–210	2	80–100 <sup>1)</sup>

 Function /  Temperature /  <sup>5</sup><sub>1</sub> Shelf level /  Cooking duration















 Fan plus /  Conventional heat





\* If you are using FlexiClip telescopic runners (depending on model), fit them one level lower.

- 1) Roast with the lid on first. Then remove the lid three-quarters of the way through roasting and add approx. 0.5 litre liquid.
- 2) Pre-heat the oven. Do not use the Rapid heat-up function  for this.
- 3) Add approx. 0.5 litre liquid halfway through roasting.



## Poultry, fish

		 [°C]	 <sup>5</sup> *	 [min]
Poultry, 0.8–1 kg		<b>180–190</b>	2	<b>60–70</b>
		190–200	2	60–70
Poultry, approx. 2 kg		<b>180–190</b>	<b>2</b>	<b>100–120</b>
		190–200	2	100–120
Poultry, stuffed, approx. 2 kg		<b>180–190</b>	<b>2</b>	<b>110–130</b>
		190–200	3	110–130
Poultry, approx. 4 kg		<b>160–170</b>	<b>2</b>	<b>120–160</b> <sup>1)</sup>
		180–190	2	120–160 <sup>1)</sup>
Fish, whole, approx. 1.5 kg		160–170	2	45–55
		<b>180–190</b>	<b>2</b>	<b>45–55</b>

 Function /  Temperature / <sup>5</sup> Shelf level /  Cooking duration

 Fan plus /  Conventional heat

\* If you are using FlexiClip telescopic runners (depending on model), fit them one level lower.

1) Add approx. 0.5 litre liquid halfway through roasting.

# Low temperature cooking

This method is ideal for cooking beef, pork, veal or lamb when a tender result is required.

First sear the meat all over at a high temperature on the hob in order to seal it.

Then place the meat in the pre-heated oven where the low temperature and long cooking duration will cook it to perfection and ensure it is very tender.

The meat will relax and the juices inside will start to circulate evenly throughout the meat to reach the outer layers. This will give very tender and succulent results.

## Tips

- Use lean meat which has been correctly hung and trimmed. Bones should be removed before cooking.
- For searing, use a suitable cooking oil or fat that can withstand high temperatures (e.g. clarified butter, vegetable oil).
- Do not cover meat during cooking.

Cooking takes between 2-4 hours depending on the size and weight of the meat and on how well cooked you want it as well as the level of browning required.

## Procedure

Use the universal tray with the rack placed on top of it.

Do not use the Rapid Heat-up  function to pre-heat the oven.

- Place the rack together with the universal tray on shelf level 2.
- Select Conventional heat  and a temperature of 130 °C.
- Pre-heat the oven together with the universal tray and rack for approx. 15 minutes.
- Whilst the oven is pre-heating, sear the meat thoroughly on the hob.

 Danger of burning.

Wear oven gloves when placing hot food in the oven or removing it and when adjusting oven shelves etc. in a hot oven

- Place the seared meat on the rack.
- Reduce the temperature to 100 °C.
- Continue cooking until the end of the cooking duration.



On ovens with a clock/timer, you can set this procedure to finish automatically, see the "Clock/timer - Set the cooking duration").

# Low temperature cooking

## After cooking

- Meat can be carved straight from the oven. It does not need to rest.
- The cooking result will not be affected if the meat is left in the oven after the programme has finished. It can be kept warm until you serve it.
- The meat is an ideal temperature to eat straight away. Serve on pre-heated plates with very hot sauce or gravy to prevent it cooling down too quickly.

## Cooking duration / Core temperatures

Meat	 [min]	 [°C]
Fillet of beef	80–100	59
Sirloin joint		
– Rare	50–70	48
– Medium	100–130	57
– Well done	160–190	69
Pork fillet	80–100	63
Gammon *	140–170	68
Fillet of veal	80–100	60
Saddle of veal *	100–130	63
Saddle of lamb *	50–80	60

 Duration

 Core temperature

If you have a separate food probe, you can use the core temperature shown.

\* Off the bone

# Grilling



Danger of burning.

Grill with the oven door closed. If you grill with the door open, hot air will escape from the oven instead of being cooled by the cooling fan. The controls will get hot.

## Functions

### Grill

For grilling larger quantities of thin cuts (e.g. steaks) and browning baked dishes.

The whole of the top heating / grill element will get hot and glow red.

### Fan grill

For grilling larger items, e.g. rolled meat, poultry.

The top heating / grill element and the fan switch on and off alternately.

## Trays and racks

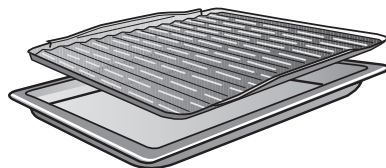
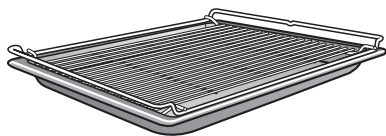

Use the universal tray with the rack or anti-splash insert (if available) on top. The juices from the food being cooked collect under the insert. This prevents them from spitting and making the oven dirty. The juices can then be used for making gravy and sauces.

Do not use the baking tray.

## Preparing food for grilling

Trim the meat. Do not season meat with salt before grilling as this draws the juices out.

Add a little oil to lean meat if necessary. Do not use other types of fat as they can burn and cause smoke.

Clean fish in the normal way. To enhance the flavour, add a little salt or squeeze a little lemon juice over the fish.

## Grilling

- Place the rack or the anti-splash insert (if available) in the universal tray.
- Place the food on top.
- Select the required oven function and the temperature.
- Pre-heat the grill for approx. 5 minutes with the door closed.



**Danger of burning.**

Wear oven gloves when placing hot food in the oven or removing it and when adjusting oven shelves etc. in a hot oven

- Place the food on the appropriate shelf level (see the Grilling chart).
- Close the door.
- Turn the food halfway through grilling.

# Grilling

---

## Notes on the grilling chart

The data for the recommended function is printed in bold.

Check the food after the shortest duration quoted.

Take note of the temperature range, the shelf levels and the durations. These take the size of the meat and cooking practices into account.

## Temperature

As a general rule, select the lower temperature given in the chart. If higher temperatures are used, the meat will brown on the outside, but will not be properly cooked through.

## Pre-heating

Pre-heating is essential for grilling. Always pre-heat the top heat/grill element for approx. 5 minutes with the door closed.

## Shelf level

Select the shelf level according to the thickness of the food.

- Thin cuts: shelf level 4 or 5
- Thick cuts: shelf level 2 or 3

## Grilling duration

- Thin pieces of fish and meat usually take 6–8 minutes per side. Thicker pieces require more time for each side. It is best to grill food of a similar thickness at the same time so that the grilling time for each item does not vary too greatly.
- Turn the food halfway through grilling.

## Testing to see if cooked

One way of finding out how well a piece of meat has been cooked is to press down on it with a spoon:















- |            |  |
|------------|--|
| Rare:      | If the meat gives easily to the pressure of the spoon, it will still be red on the inside. |
| Medium:    | If there is some resistance, the inside will be pink.                                      |
| Well-done: | If there is very little resistance, it is cooked through.                                  |

Check if the meat is cooked after the shortest time quoted.

**Tip:** If the surface of thicker cuts of meat is cooked but the centre is not cooked, continue grilling at a lower temperature setting or use a lower shelf level to allow the food to cook through to the centre.

## Grilling chart

Pre-heat the grill for approx. 5 minutes with the door closed.

Food to be grilled	 5 1				
		 [°C]	 [min]	 [°C]	 [min]
<b>Thin cuts</b>					
Burgers *	4 <sup>1)</sup>		<b>12–24</b>	–	–
Kebabs	4 <sup>1)</sup>	220	12–17	<b>220</b>	<b>12–17</b>
Chicken kebabs	4 <sup>1)</sup>	220	12–17	<b>220</b>	<b>12–17</b>
Pork chops	4 <sup>1)</sup>		<b>16–24</b>	240	13–22
Liver	3 <sup>1)</sup>		<b>8–12</b>	220	8–12
Burgers	4 <sup>1)</sup>		<b>10–20</b>	240	17–22
Bratwurst	3 <sup>1)</sup>		<b>8–15</b>	220	10–17
Fish fillet	4 <sup>1)</sup>	220	15–25	220	<b>15–25</b>
Trout	4 <sup>1)</sup>	220	15–25	220	<b>15–25</b>
Toast *	3	 <sup>2)</sup>	<b>5–8</b>	–	–
Cheese toast	3 <sup>1)</sup>	220	8–12	<b>220</b>	<b>8–12</b>
Tomatoes	4 <sup>1)</sup>	220	6–10	220	<b>8–12</b>
Peaches	2/3 <sup>1)</sup>		5–10	<b>220</b>	<b>5–10</b>
<b>Thicker cuts</b>					
Chicken, approx. 1.2 kg	1	220	60–70	<b>190</b>	<b>55–65</b>
Pork knuckle, approx. 1 kg	2 <sup>1)</sup>	–	–	<b>180</b>	<b>80–90</b>

 Grill /  Fan grill

 <sup>5</sup> Shelf level /  Temperature /  Duration

\* The settings also apply when using the Full grill  function for testing in accordance with EN 60350-1.

Do not use the FlexiClip telescopic runners (depending on model).

- 1) If you are using FlexiClip telescopic runners (depending on model), fit them one level lower.
- 2) Do not pre-heat the grill.

## Further applications

### Defrost

Use Fan plus  without setting the temperature for gently defrosting food.

The fan will switch on and circulate air at room temperature around the oven cavity.



 **Danger of salmonella poisoning.** It is particularly important to observe food hygiene rules when defrosting poultry. Do not use the liquid from the defrosted poultry. Pour it away, and wash the tray, the sink and your hands.

### Tips

- Where possible, remove the packaging and put the food to be defrosted on the universal tray or into a suitable dish.
- When defrosting poultry, put it on the rack over the universal tray to catch the defrosted liquid so that the meat is not lying in this liquid.
- Fish does not need to be fully defrosted before cooking. Defrost so that the surface is sufficiently thawed to take herbs and seasoning.

### Defrosting durations

The duration needed for defrosting depends on the type and weight of the food.

Frozen food	 [g]	 [min]
Chicken	800	90–120
Meat	500	60–90
	1000	90–120
Bratwurst	500	30–50
Fish	1000	60–90
Strawberries	300	30–40
Butter cake	500	20–30
Bread	500	30–50

 weight /  defrosting duration



### Gentle bake

Gentle Bake is suitable for small amounts, e.g. frozen pizzas, bake-off rolls, biscuits and for meat dishes and roasts. The optimal use of residual heat enables savings of up to 30% energy to be made compared to cooking with a standard oven function with comparatively good cooking results.

This function is not suitable for larger amounts of food such as sponge cakes and fresh fruit cake where the cake mix needs to be thoroughly baked throughout. No energy savings would be achieved.

The temperature can be set between 100 and 250 °C.

For optimum results keep the door shut whilst cooking.

Examples of use:

Food	🌡️ [°C]	🕒 [min]
Biscuits	150	25–30
Ratatouille	180	40–60
Fish fillet in foil approx. 500 g	200	25–35
Frozen pizza, pre-cooked	200	20–25
Ham roast, approx. 1.5 kg	160	130–160
Braised beef, approx. 1.5 kg	180	160–180

🌡️ Temperature / 🕒 Duration

- Use shelf level 1 or 2 depending on the height of the food.
- The durations given are for an oven which has not been pre-heated.
- Roast with the lid on first. Remove the lid three quarters of the way through the cooking duration and add approx. 0.5 litres of liquid.
- Check the food after the shortest duration quoted.

# Further applications

---

## Frozen food/Ready meals

### Tips

#### Cakes, pizza, baguettes

- Large frozen items such as cakes, pizzas or baguettes cover an extensive area of the baking tray or universal tray.  
The temperature difference if large frozen items are cooked in these trays can cause the tray to distort in such a way that it cannot be removed from the oven when it is hot. Further use will make the distortion worse. Place this type of food on baking parchment on the rack to prevent the risk of this happening.
- Use the lowest temperature recommended on the manufacturer's packaging.

#### Oven chips, croquettes or similar items

- Small items of frozen food such as oven chips can be cooked on the baking tray or universal tray.  
Place baking parchment on the tray so that they cook gently.
- Use the lowest temperature recommended on the manufacturer's packaging.
- Turn several times during cooking.

## Method

Eating food which has been cooked correctly is important for good health.

Only bake cakes, pizza, chips etc. until they are golden. Do not over-cook them.

- Select the function and temperature recommended on the manufacturer's packaging.
- Pre-heat the oven.
- Place the food in the pre-heated oven on the shelf level recommended on the packaging.
- Check the food at the end of the shortest duration recommended on the packaging.



### Drying food





Drying is a traditional method of preserving fruit, certain vegetables and herbs.

It is important that fruit and vegetables are ripe and not bruised before they are dried.

- Prepare the food for drying
  - Peel and core apples, and cut into slices 0.5 cm thick.
  - Stone plums, if necessary.
  - Peel, core and cut pears into thick wedges.
  - Peel and slice bananas.
  - Clean mushrooms and cut them in half or slice them.
  - Remove parsley and dill from the stem.
- Distribute the food evenly over the universal tray.

Use the Gourmet perforated baking tray, if you have one.

- Select Fan plus  or Conventional heat .
- Select a temperature of 80–100 °C.
- Place the universal tray on shelf level 2.  
With Fan plus  you can dry produce on levels 1+3 at the same time.

Food		 [min]
Fruit		120–480
Vegetables		180–480
Herbs		50–60

-  Function /  Drying time
-  Fan plus /  Conventional heat

- Reduce the temperature if condensation begins to form in the oven.

 Danger of burning. Wear oven gloves when removing the dried food from the oven.

- Allow the dried fruit or vegetables to cool down after drying.

Dried fruit must be completely dry, but also soft and elastic.

- Store in sealed glass jars or tins.

## Further applications

---

### Heat crockery

Use Fan plus  for pre-heating crockery.

Only pre-heat heat-resistant dishes.

- Place the rack on shelf level 2 and place the crockery on it. Depending on the size of the crockery you can also use the oven floor and also take the side runners out to make more room.
- Select Fan plus .
- Set the temperature to 50–80 °C.

 Danger of burning.

Wear oven gloves when removing the dishes from the oven. Droplets of water may have accumulated underneath the dish.

- Remove the heated crockery from the oven.



## Danger of burning.

Make sure the oven heating elements are switched off and that the oven cavity is cool.



## Danger of injury.

The steam from a steam cleaning appliance could reach electrical components and cause a short circuit. Do not use a steam cleaner to clean the oven.

All surfaces can become discoloured or damaged if unsuitable cleaning agents are used. The front of the oven, in particular, will be damaged by oven cleaners.

All surfaces are susceptible to scratching. Scratches on glass surfaces could cause a breakage in certain circumstances.

Remove any residual cleaning agent immediately.

## Unsuitable cleaning agents

To avoid damaging the surfaces, do not use:

- cleaning agents containing soda, ammonia, acids or chlorides
- cleaning agents containing descaling agents on the oven front
- abrasive cleaning agents, e.g. powder cleaners and cream cleaners
- solvent-based cleaning agents
- stainless steel cleaning agents
- dishwasher cleaner
- glass cleaning agents
- cleaning agents for ceramic hobs
- hard, abrasive brushes or sponges, e.g. pot scourers, brushes or sponges which have been previously used with abrasive cleaning agents
- melamine eraser blocks
- sharp metal scrapers
- wire wool
- spot cleaning
- oven cleaner
- stainless steel spiral pads

If soiling is left on for any length of time, it may become impossible to remove. If items are used frequently without being cleaned, it may become very difficult to clean them.

Soiling is best removed after each use of the oven.

## Cleaning and care

---

The accessories are not dishwasher-proof.

### Tips

- Soiling caused by spilt juices and cake mixtures is best removed whilst the oven is still warm. Exercise caution and make sure the oven is not too hot - danger of burning.
- To make manual cleaning easier you can dismantle the oven door, remove the side runners and the FlexiClip runners (if present) and lower the top heating/grill element.

### Normal soiling

The fibre glass seal around the front of the oven should be handled carefully. Do not rub and scour it. If possible you should avoid trying to clean it.

- It is best to remove normal soiling immediately using a clean sponge and a solution of hot water and washing-up liquid or with a clean, damp microfibre cloth.
- After cleaning make sure all residual cleaning agent is thoroughly removed with clean water. This is particularly important when cleaning PerfectClean surfaces as cleaning agent residues can impair the non-stick properties.
- After cleaning, wipe the surfaces dry using a soft cloth.

### Stubborn soiling (excluding the FlexiClip runners)

Spilt fruit and roasting juices may cause lasting discolouration or matt patches on enamelled surfaces. This discolouration is permanent but will not affect the efficiency of the finish. Do not attempt to remove these marks. Clean these following the instructions given here.

- Baked on deposits can be removed with a glass scraper or with a non-abrasive stainless steel spiral pad, warm water and washing-up liquid.
- Very stubborn soiling on PerfectClean surfaces can be cleaned using Miele Oven Cleaner. This cleaner must only be applied to cold surfaces. Follow the instructions on the packaging

Non-Miele oven cleaner must only be used in a cold oven and for no longer than a maximum of 10 minutes.

- You can then also use the scouring pad on the back of a washing-up sponge to remove the soiling.
- After cleaning, remove all oven cleaning agent residues thoroughly with clean water, and dry with a soft cloth.

## Cleaning and care

---

### Stubborn soiling on the Flexi-Clip runners

Never attempt to clean FlexiClip telescopic runners in a dishwasher. This would remove the special grease which is essential for their smooth functioning.

For stubborn surface soiling or if the bearings become sticky with spilled fruit juices proceed as follows:

- Soak the FlexiClip runners for approx. 10 minutes in a solution of hot water and washing-up liquid. If necessary use the back of a washing-up sponge to remove the soiling. The bearings can be carefully cleaned with a soft brush.

Cleaning may cause some discolouration or fading in places, however this will not affect the functioning of the runners in any way.



## Pyrolytic cleaning of the oven interior

Instead of cleaning the oven manually you can run the Pyrolytic cleaning programme .

During pyrolytic cleaning the oven interior is heated up to over 400 °C. Any residual soiling is broken down and reduced to ash by the high temperatures.

This oven has three levels of pyrolytic cleaning, each with a different duration. Select:

- Level 1 for light soiling
- Level 2 for heavier soiling
- Level 3 for very heavy soiling

The oven door locks automatically as soon as the Pyrolytic cleaning programme starts. It cannot be opened until after the programme has finished.

The timer can be used to delay the start of pyrolytic cleaning, for instance to make use of cheaper electricity tariffs.

At the end of pyrolytic cleaning any residues such as ash from the pyrolytic process can be easily wiped away.

## Setting up for pyrolytic cleaning

Remove all accessories as well as the runners and any extra accessories such as FlexiClip runners from the oven interior before starting the Pyrolytic cleaning programme. The high temperatures needed for pyrolysis will damage them.

- Take the side runners out (see "Cleaning and care – Removing the side runners with FlexiClip runners") and remove any other accessories from the oven cavity.

Coarse soiling in the oven compartment can cause an accumulation of smoke which can lead to the pyrolytic cleaning programme switching off. Burnt on residues can leave discolouration or matt areas on enamelled surfaces.

- Before running the pyrolytic cleaning programme, remove coarse soiling from the oven compartment and loosen any burnt on residues with a scraper suitable for use on glass.

## Cleaning and care

### Starting Pyrolytic cleaning



Danger of burning.

The oven door gets much hotter during pyrolytic operation than during normal use.

Prevent children from touching the oven during pyrolytic cleaning.

- Select Pyrolytic cleaning



*PY 1* will appear. The digit will flash.

Choose between *PY 1*, *PY 2* and *PY 3* using < or >.

- Select the level required.
- Confirm with *OK*.

Pyrolytic cleaning will now start.

will also appear in the display.



While is flashing, the door is locked automatically. lights up as long as it is locked.

Then oven heating and temperature control switch on automatically, even if the temperature selector is in the • position.

If you wish to follow the progress of the pyrolytic cleaning programme, you will need to call up the duration

- Confirm with *OK*.
- Press > continuously until flashes.

The time remaining of the pyrolytic cleaning programme will appear in the display. You cannot alter the duration.

If you have set a minute minder duration in the meantime, when the duration has elapsed a buzzer will sound, will flash and the time will start counting up. When you confirm with *OK*, acoustic and optical signals are switched off. *PY* and the digit of the pyrolytic cleaning programme selected will appear again.

## To delay the start time of the pyrolytic cleaning programme

Start the pyrolytic cleaning programme as described and delay the end time within the first five minutes.

- Confirm with *OK*.
- Press > continuously until  flashes.

The end time, calculated from the current time of day plus the duration of the pyrolytic cleaning programme selected, will appear in the display.

- Confirm with *OK*.

The hours will flash.

- Set the hours using >.

- Confirm with *OK*.

The minutes will flash.

- Use > to set the minutes.

- Confirm with *OK*.

The end time set is now saved.



The oven heating switches off.

The end time can be changed at any time up to the start of the programme.

As soon as the start time has been reached, the oven heating, lighting and cooling fan will switch on and the duration will appear in the display.



## At the end of pyrolytic cleaning

First 0:00,  and  appear.

As long as  lights up, the door is locked. When  flashes, the door is unlocked.



When the door lock is released:

-  goes out.
-  will flash.
- A buzzer will sound if switched on (see "Clock/timer - Changing settings").
- Turn the function selector to **0**.

The visual and acoustic signals will switch off.

 **Danger of burning. Do not remove any pyrolytic residues until the oven cavity has cooled down.**

## Cleaning and care



- Clean the oven cavity to remove any pyrolytic residues (e.g. ash) that can build up depending on the degree of soiling in the oven cavity.

There is a delicate fibreglass seal around the oven cavity to seal the glass in the oven door. This can be damaged by rubbing or scouring. Do not clean it if possible.

### Tips

- Most residues can be removed with warm water, a little washing-up liquid and a clean sponge or a clean, damp microfibre cloth.
- Depending on the level of soiling, a visible deposit could build up on the glass on the inside of the oven door. This can be removed with a dish-washing sponge, a glass scraper or a stainless steel spiral and a little washing-up liquid.
- Enamelled surfaces can be permanently discoloured by spilt fruit juice. Such discolouration does not affect the properties of the enamel. Do not attempt to remove these marks.

### If pyrolytic cleaning is cancelled

If pyrolytic cleaning is cancelled, the oven door will remain locked until the temperature inside the oven drops to below 280 °C.  remains lit up until the temperature of the oven cavity has fallen below this temperature. When  flashes, the door is unlocked.

The following will cause the pyrolytic cleaning programme to stop:

- Turn the function selector to another function or to the **0** position.

Turn the function selector to Pyrolytic cleaning  again, if you want to start the pyrolytic cleaning programme anew.

- A power cut.

When power is restored, *Py* remains lit up until the temperature of the oven cavity has fallen below 280 °C. After that the numeric block will appear,  will flash and the door will unlock. Then *Py* will flash in the display.

- Confirm with *OK* if you want to start the pyrolytic cleaning programme again. Then you can select the pyrolytic cleaning programme you want and start it again.

As soon as you turn the function selector to the **0** position following an interruption to the power supply, *Py* will carry on flashing. Confirm with *OK* to enter the time of day again (see "Before using for the first time").

## Removing the door

The door weighs approx. 10 kg.

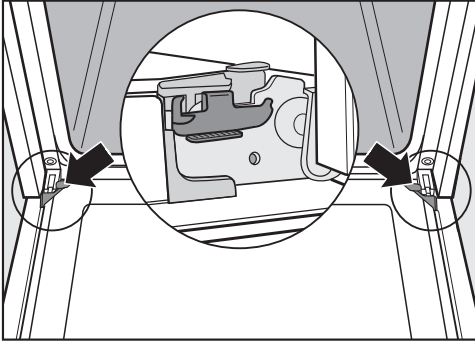

The door is connected to each door hinge by retainers. Before the door can be removed the locking clamps on both hinges must first be unlocked.

- Open the door fully.

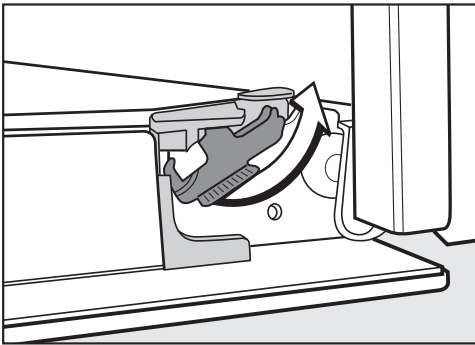

- Release the locking clamps by turning them as far as they will go.

Do not attempt to take the door off the retainers when it is in the horizontal position as the retainers will spring back against the oven.

Do not use the handle to pull the door off the retainers as the handle could break.

- Raise the door up till it rests open.



- Holding the door securely at both sides lift it upwards off the retainers. Make sure you take it off straight.

# Cleaning and care

---

## Dismantling the door

The oven door is an open system with 4 glass panes which have a heat-reflective coating on some of their surface.

When the oven is operating, air is directed through the door to keep the outer pane cool.

If soiling has worked its way in between the glass panes, the door can be dismantled in order to clean in between the panes.

Take particular care as scratches can damage the glass. When cleaning the glass panes do not use abrasive cleaning agents, hard sponges or brushes and do not use sharp metal tools or scrapers.

Please also read the general notes on cleaning the oven front before cleaning the glass panes.

The glass panes are coated in different ways with a heat-reflective coating on the sides facing into the oven cavity. The glass panes must be fitted the right way round after being cleaned.

Oven spray will damage the aluminium trims inside the door. These should only be cleaned using hot water and washing-up liquid applied with a clean sponge or a clean, damp microfibre cloth.

Be especially vigilant after dismantling the door that the glass panes do not break.

## Cleaning and care

 **Danger of injury.**  
Always remove the door before disassembling it.

- Place the door on a protective surface (e.g. on a tea towel) with the outside pane facing downwards to prevent it getting scratched. The door handle should line up with the edge of the table so that the glass lies flat and does not get broken during cleaning.

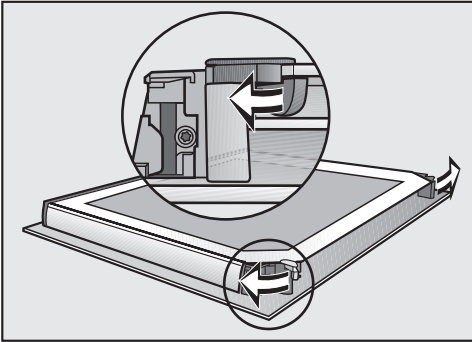

- Flip the two glass pane retainers outwards to open them.

You can now remove the inner panes and the two middle panes one after the other.

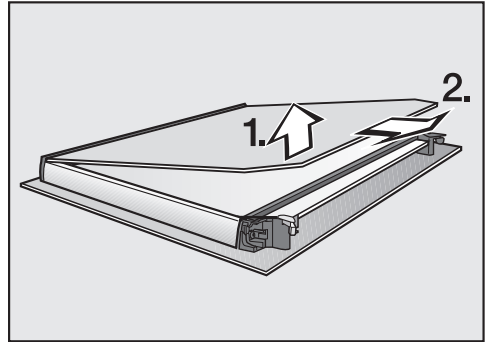

- **Carefully** lift the inner pane up and out of the plastic strip.

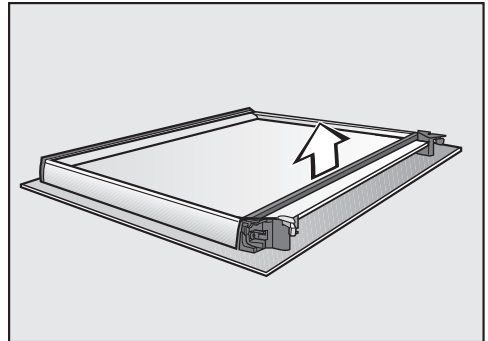

- Remove the seal.

## Cleaning and care

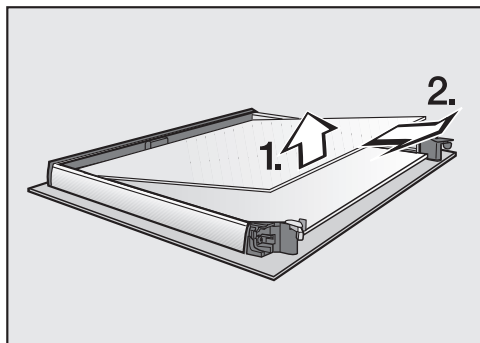

- Carefully lift the top of the two middle panes up and take it out.

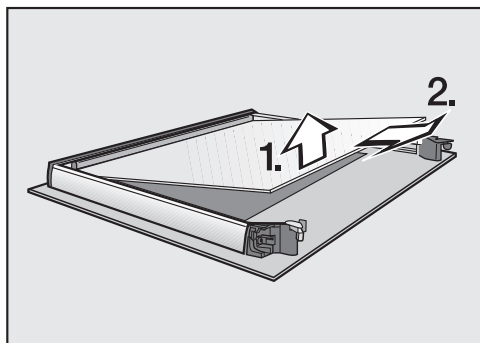

- Then lift the bottom of the two middle panes up carefully and take it out.
- Clean the door panes and other parts with a clean sponge and a solution of hot water and washing-up liquid or a clean damp microfibre cloth.
- Dry all parts with a soft cloth.

Then reassemble the door carefully:

The two middle panes are identical. To help you put them back in correctly the material number is printed on the panes.

- Refit the lower of the two middle panes in such a way that the material number is legible (not a mirror image).

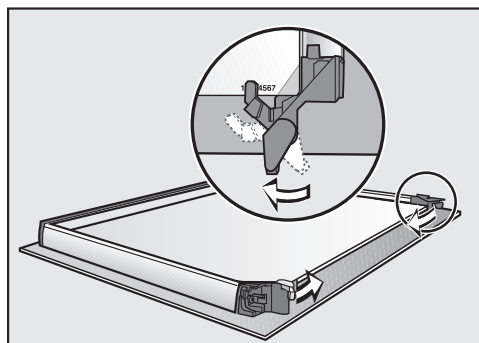

- Flip both the glass pane retainers inwards in such a way that they fit over the lower of the two middle panes.
- Then refit the upper of the middle two panes in such a way that the material number is legible (not a mirror image). The glass pane should lie on top of the retainers.



## Cleaning and care

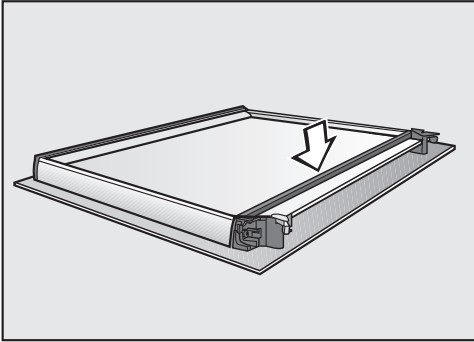

- Refit the seal.

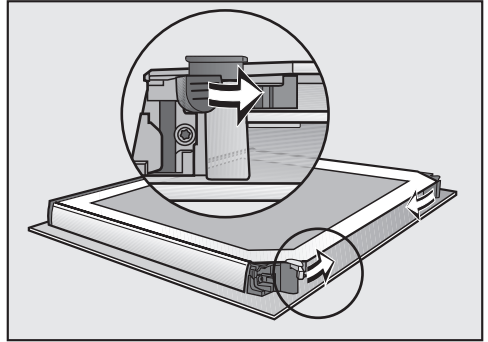

- Flip both the glass pane retainers inwards to close them.

The door is now reassembled and is ready to fit back on the oven.

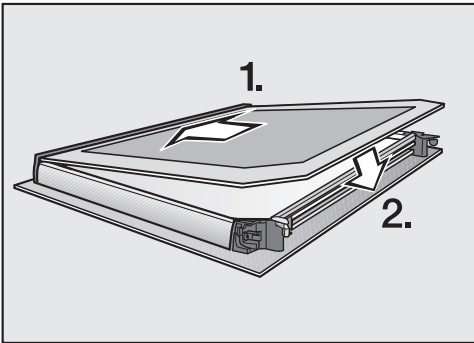

- Push the inner pane with the matt printed side facing downwards into the plastic strip and place it between the retainers.

# Cleaning and care

## Refitting the door

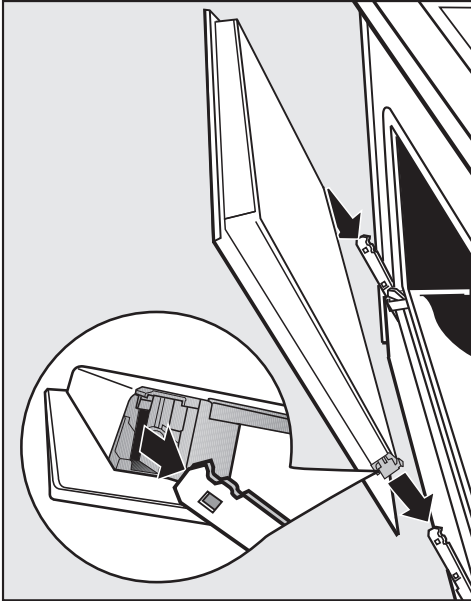

- Hold the door securely on both sides and carefully fit it back into the hinge retainers. Make sure that the door goes back on straight.

- Open the door fully.

If the locking clamps are not locked, the door could work loose resulting in damage.

Ensure that the locking clamps are locked after refitting the door.

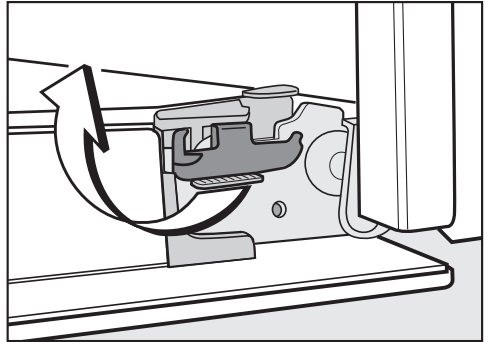

- Flip both locking clamps back up as far as they will go into a horizontal position.

### Removing the side runners with FlexiClip runners

You can remove the side runners together with the FlexiClip runners (if present).

If you wish to remove the FlexiClip runners separately beforehand, please follow the instructions in "Features – Fitting and removing FlexiClip telescopic runners".

 Danger of burning.  
Make sure the oven heating elements are switched off and cool.

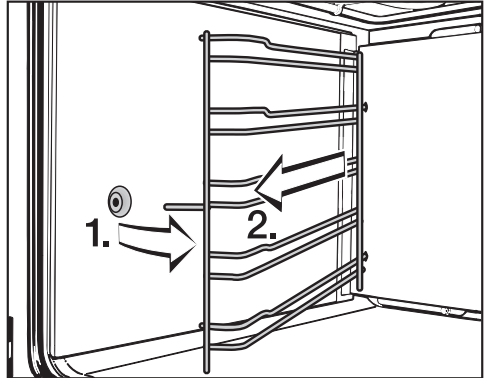

- Pull the side runners out of holder (1) at the front of the oven and then pull them out of the oven (2).

**Refit** in the reverse order.

- Take care and ensure that all parts are correctly fitted.

## Cleaning and care

---

### Lowering the top heat/grill element

 Danger of burning.

Make sure the oven heating elements are switched off and that the oven cavity is cool.

- Remove the side runners.

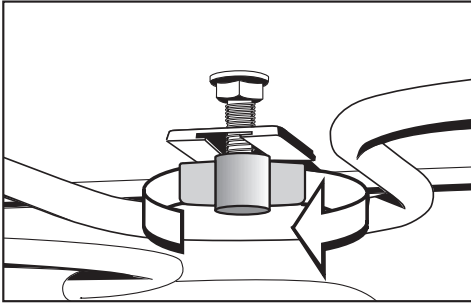

- Undo the wing nut.

Use caution not to damage the top heat/grill element.

Do not use force when lowering the top heat/grill element.

- Carefully lower the top heat/grill element.

You can now clean the roof of the oven.

- Raise the top heat/grill element and tighten the wing nut securely.
- Refit the side runners.



## Problem solving guide

Many malfunctions and faults that can occur in daily operation can be easily remedied. Time and money will be saved because a service call will not be needed.

The following guide may help you to find the reason for a malfunction or a fault, and to correct it.

Problem	Cause and remedy
<b>The display is dark.</b>	There is no power to the oven. ■ Check whether the mains fuse has tripped. If it has, contact a qualified electrician or Miele.
<b>The oven does not heat up.</b>	You have only selected an oven function or a temperature. ■ Select both a function <b>and</b> a temperature.
	The system lock  has been activated. ■ Switch off the system lock (see "Clock/timer - Altering settings").
	There is no power to the oven. ■ Check whether the mains fuse has tripped. If it has, contact a qualified electrician or Miele.

## Problem solving guide

Problem	Cause and remedy
<b>12:00 is flashing in the display.</b>	<p>There has been a power cut.</p> <ul style="list-style-type: none"> <li>■ Reset the time of day (see "Using for the first time").</li> </ul> <p>Cooking times will also need to be reset.</p>
<b>Py is lit up or flashing in the display.</b>	<p>There has been a power cut which has caused the Pyrolytic cleaning programme to stop.</p> <div data-bbox="404 408 1042 528" style="border: 1px solid gray; padding: 5px;"> <p>The  symbol will remain lit up and the door locked until the temperature inside the oven drops to below 280 °C.</p> </div> <ul style="list-style-type: none"> <li>■ The time of day display will start flashing as soon as you turn the function selector to <b>0</b>. Please enter the time of day again (see "Before using for the first time").</li> </ul>
<b>0:00 appears unexpectedly in the display and the  symbol flashes at the same time. The buzzer may also be sounding.</b>	<p>The oven has been operating for an unusually long time and this has activated the safety switch-off function.</p> <ul style="list-style-type: none"> <li>■ Turn the function selector to <b>0</b>. The oven is now ready to use again immediately.</li> </ul>
<b>F 32 appears in the display.</b>	<p>The door has not locked for the Pyrolytic cleaning programme.</p> <ul style="list-style-type: none"> <li>■ Turn the function selector to the <b>0</b> position and select the Pyrolytic programme you want again.</li> </ul> <p>If the problem persists, contact Miele Service.</p>
<b>F 33 appears in the display.</b>	<p>The door lock has not unlocked after the Pyrolytic cleaning programme.</p> <ul style="list-style-type: none"> <li>■ Turn the function selector to the <b>0</b> position.</li> </ul> <p>If the problem persists, contact Miele Service.</p>
<b>F XX appears in the display,</b>	<p>There is a problem that you cannot resolve.</p> <ul style="list-style-type: none"> <li>■ Call Miele Service.</li> </ul>
<b>A noise can be heard after a cooking process.</b>	<p>The cooling fan will continue to run for a while after the oven has been switched off to prevent any humidity building up in the oven, on the control panel or in the oven housing unit.</p> <p>This cooling fan will switch itself off automatically after a certain period of time.</p>

## Problem solving guide

Problem	Cause and remedy
<p><b>Cakes and biscuits are not sufficiently baked in the times given in the chart</b></p>	<p>A different temperature from the one given in the recipe was used.</p> <ul style="list-style-type: none"> <li>■ Select the temperature required for the recipe.</li> </ul>
	<p>The ingredient quantities are different from those given in the recipe.</p> <ul style="list-style-type: none"> <li>■ Double check the recipe. The addition of more liquid or more eggs makes a moister mix which would take longer to cook.</li> </ul>
<p><b>Browning is uneven.</b></p>	<p>The wrong temperature or shelf level was selected.</p> <ul style="list-style-type: none"> <li>■ There will always be a slight unevenness. If the unevenness is pronounced, check that the correct temperature and shelf level have been selected.</li> </ul>
	<p>The material or colour of the baking tin is not suitable for the oven function.</p> <ul style="list-style-type: none"> <li>■ When using Conventional heat  use matt, dark coloured tins. Light coloured, shiny pans will not produce as desirable results.</li> </ul>
<p><b>FlexiClip runners are not running smoothly.</b></p>	<p>The bearings in the FlexiClip runners are not sufficiently lubricated.</p> <ul style="list-style-type: none"> <li>■ Lubricate the bearings with the special Miele lubricant.</li> </ul> <p>Only use this special lubricant, as it is designed to withstand high temperatures in the oven. Other lubricants can harden and stick to the FlexiClip runners when they are heated. The Miele lubricant is available to order from Miele or via the online Miele shop.</p>

## Problem solving guide

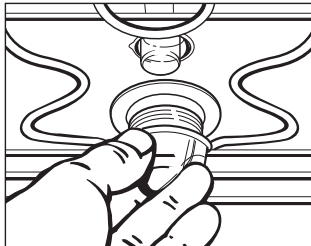
Problem	Cause and remedy
<p data-bbox="73 201 344 256"><b>The top oven lighting does not turn on.</b></p> 	<p data-bbox="398 201 818 229">The halogen lamp needs replacing.</p> <div data-bbox="404 236 1043 363" style="border: 1px solid gray; padding: 5px;"><p data-bbox="415 244 689 280">⚠ Danger of burning. Make sure the oven heating elements are switched off and that the oven cavity is cool.</p></div> <ul data-bbox="398 384 1034 679" style="list-style-type: none"><li>■ Disconnect the appliance from the mains.</li><li>■ Turn the lamp cover a quarter turn anti-clockwise to release it and then pull it together with its seal downwards to take it out.</li><li>■ Replace it with a new halogen lamp (Osram 66725 AM/A, 230 V, 25 W, G9).</li><li>■ Refit the lamp cover together with its seal and turn clockwise to secure.</li><li>■ Reconnect the oven to the electricity supply.</li></ul>
<p data-bbox="73 695 362 815"><b>The door cannot be opened at the end of a Pyrolytic cleaning programme.</b></p>	<p data-bbox="398 695 995 751">The door lock has not unlocked after the Pyrolytic cleaning programme.</p> <ul data-bbox="398 759 975 855" style="list-style-type: none"><li>■ Turn the function selector to <b>0</b>.</li><li>■ If the door lock still does not release itself call Miele Service.</li></ul>
<p data-bbox="73 871 370 959"><b>There is soiling in the oven after the Pyrolytic cleaning programme.</b></p>	<p data-bbox="398 871 1034 927">The Pyrolytic cleaning programme burns off soiling in the oven and leaves it as ash.</p> <ul data-bbox="398 935 1034 1123" style="list-style-type: none"><li>■ Remove the ash using warm water with a little washing-up liquid with a soft sponge or a clean, damp microfibre cloth. If coarse soiling remains, run the pyrolytic cleaning programme again. Select a longer duration if necessary.</li></ul>



### After sales service

In the event of any faults which you cannot easily remedy, please contact

- your Miele Dealer, or
- Miele Service.

See end of this booklet for contact details.

Please note that telephone calls may be monitored and recorded for training purposes.

N.B. A call-out charge will be applied to service visits where the problem could have been resolved as described in these instructions.

When contacting your Dealer or Miele, please quote the model and serial number of your appliance.

This information is given on the data plate, visible on the front frame of the oven, with the door fully open.

### Warranty: UK

The appliance is guaranteed for 2 years from the date of purchase.

In the UK, you must activate your cover by calling 0330 160 6640 or registering online at [www.miele.co.uk](http://www.miele.co.uk).

### Warranty: Other countries

For information on the appliance warranty specific to your country please contact Miele. See end of this booklet for contact details.

# Electrical connection



## Danger of injury!

Installation, repairs and other work by unqualified persons could be dangerous. Miele cannot be held liable for unauthorised work.

Connection to the electrical supply must be carried out by a suitably qualified and competent person in accordance with local and national safety regulations. Ensure power is not supplied to the appliance until after installation or repair work has been carried out.

Connection of this appliance to the electricity supply must be made in accordance with current safety regulations (BS 7671 in the UK).

Connection of this appliance should be made via a fused connection unit or a suitable isolator and the on/off switch should be easily accessible after the appliance has been built in.

If the switch is not accessible after installation (depending on country) an additional means of disconnection must be provided for all poles.

When switched off there must be an all-pole contact gap of 3 mm in the isolator switch (including switch, fuses and relays according to EN 60335).

## Connection data

The required connection data are given on the data plate located on the oven trim visible when the door is open.

Ensure that these match the mains supply.

- When contacting Miele, please quote the following:
  - Model number
  - Serial number
  - Connection data (voltage/frequency/maximum connected load)

When replacing the cable supplied with another cable or changing the connection, only cable type H05VV-F with a suitable cross-sectional area (CSA) may be used.

## Oven

This oven is supplied with an approx. 1.7 m long 3-core cable for connection to a 230 V, 50 Hz supply.

The wires in the mains lead are coloured as follows:

Green/yellow = earth

Blue = neutral

Brown = live



**WARNING - THIS APPLIANCE  
MUST BE EARTHED**

For extra safety it is advisable to protect the appliance with a suitable residual current device (RCD).

Maximum connected load: see data plate.

### Electrical connection: Other countries

All electrical work should be carried out by a suitably qualified and competent Miele approved service technician in strict accordance with local and national safety regulations.

The voltage and rated load are given on the data plate situated at the front of the oven interior. Please ensure that these match the household mains supply.

For extra safety it is advisable to install a suitable residual current device (RCD) / ground fault interrupter (GFI). Contact a qualified electrician for advice.

If the cord is damaged a new cord must be fitted by a Miele approved service technician.



**WARNING - THIS APPLIANCE  
MUST BE EARTHED**

## Building-in diagrams

### Appliance and niche dimensions

Dimensions are given in mm.

#### Installation in a base unit

When building the appliance into a base unit underneath a hob please also observe the installation instructions for the hob as well as the building-in depth required for the hob.

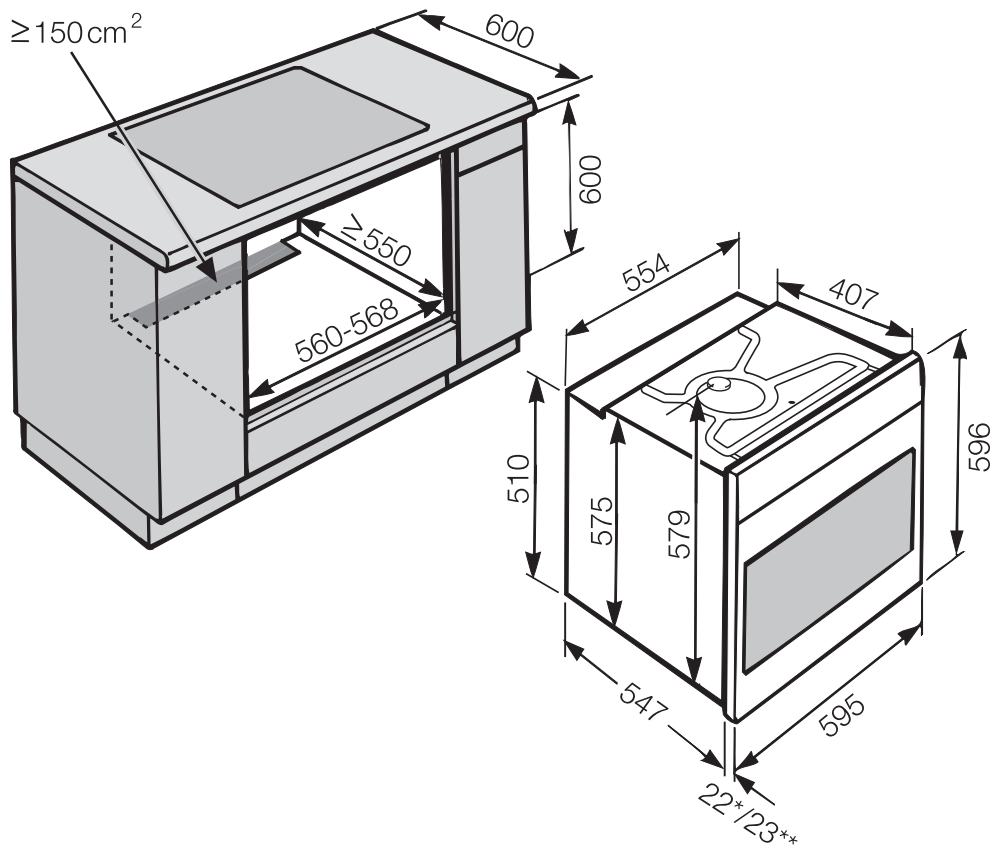

\* Ovens with glass front

\*\* Ovens with metal front

## Installation in a tall unit

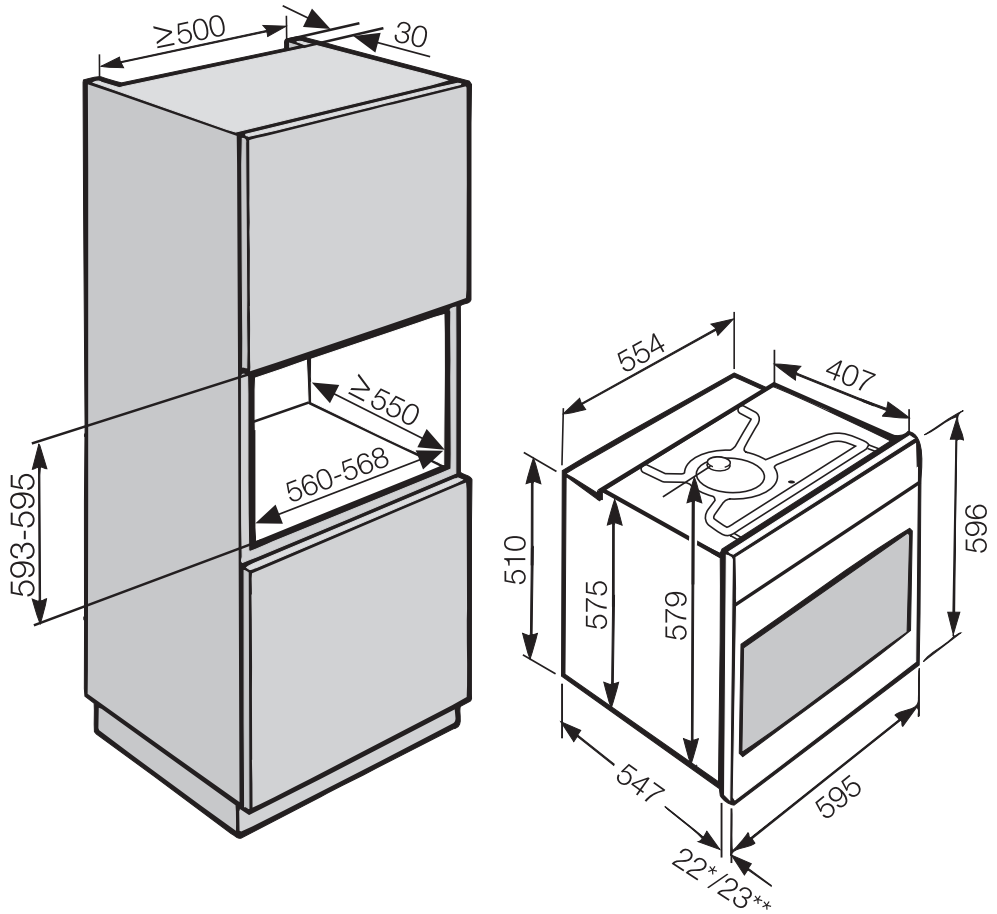

\* Ovens with glass front

\*\* Ovens with metal front

## Building-in diagrams

### Dimensions of oven front

Dimensions are given in mm.

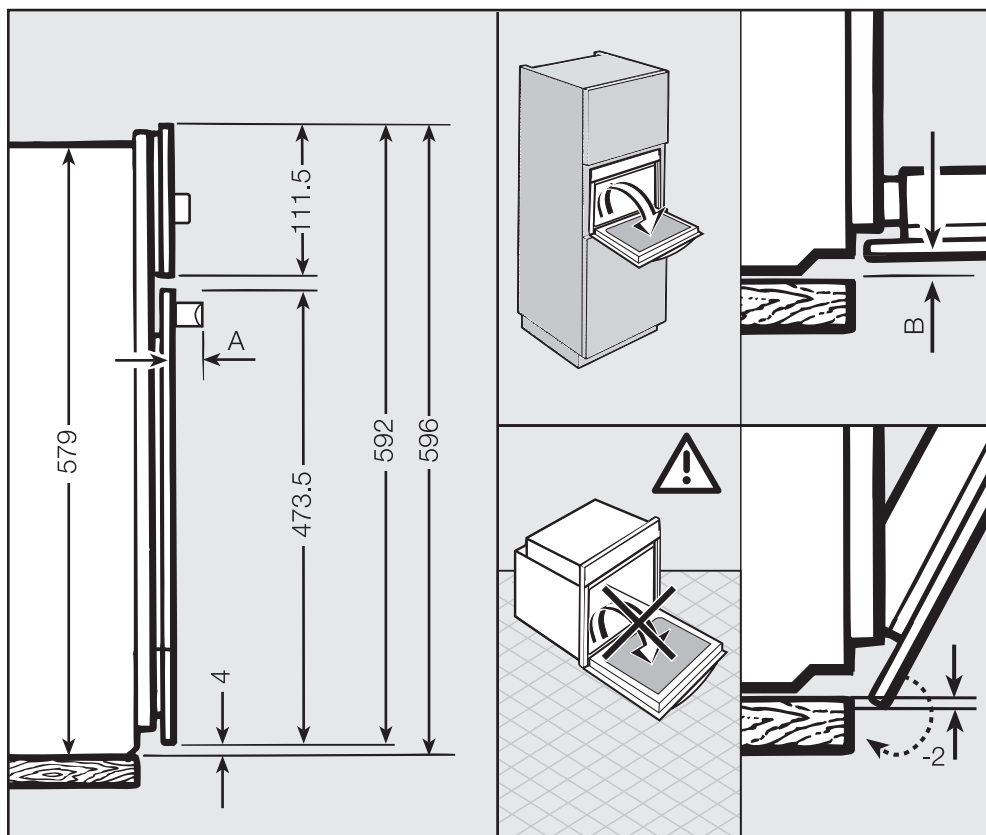

**A** H22xx: 42 mm

**B** Ovens with glass front: 2.2 mm

Ovens with metal front: 1.2 mm

# Installing the oven

 The oven must not be operated until it has been correctly installed in its housing unit.

The oven must have an adequate supply of cool air for proper operation. The required air must not be heated excessively by other heat sources, e.g. wood burning stove.

Observe the following when installing:

Do not fit a back panel in the housing unit.

Make sure that the shelf that the oven sits on does not touch the wall.

Do not fit insulation to the side walls of the housing unit.

## Before installation

- Before connecting the appliance to the mains, you must disconnect the power supply to the isolator switch or fused spur connection unit.

## Building in

- Connect the mains cable from the oven to the isolator.

Do not carry the oven by the door handle. The door can be damaged. Use the handles on each side of the casing to carry it.

It is advisable to dismantle the door before installing the appliance (see "Cleaning and Care - Dismantling the door") and remove accessories from the oven cavity. This will make it easier to install in its niche and you will not be tempted into using the handle to carry it.



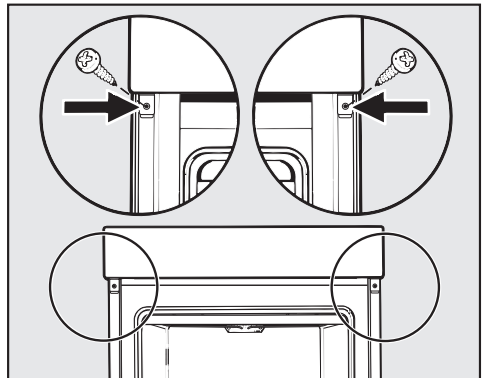















- Push the oven into the housing unit and align it.
- Open the door (if you have not removed it previously).







- Use the screws supplied to secure the oven to the side walls of the housing unit through the holes in the oven trim.
- Refit the door, if necessary (see "Cleaning and care - Refitting the door").

# Note for test institutes

## Test food acc. to EN 60350-1

Test food	Accessories		 [°C]	 <sup>5</sup> *	 [min]	Pre-heat
Drop cookies	1 tray		140	2	35–45	No
			160 <sup>4)</sup>	3	20–30	Yes
	2 trays <sup>1)</sup>		140	1+3	35–45	No
Small cakes	1 tray		150	2	30–40	No
			160 <sup>4)</sup>	3	20–30	Yes
	2 trays		150 <sup>4)</sup>	2+4	23–33	Yes
Whisked sponge	Springform <sup>2)</sup> Ø 26 cm		180 <sup>4)</sup>	2	20–30	Yes
			150–170 <sup>4)</sup>	2	30–45	Yes
Apple cake	Springform <sup>2)</sup> Ø 20 cm		160	2	90–100	No
			180	1	90–100	No
Toast	Rack			3	5–8	No
Burgers	Rack and universal tray			4	1st side: 7–12 2nd side: 5–12	Yes, 5 minutes

 Function /  Temperature / <sup>5</sup> Shelf level /  Cooking duration

 Fan plus /  Conventional heat /  Grill

\* Do not use the FlexiClip telescopic runners (depending on model).

- 1) Take the baking trays out of the oven early if the food is sufficiently browned before the specified duration has elapsed.
- 2) Use a dark coloured, matt tin and place it on the rack.
- 3) In general, if a range of temperatures is given, it is best to select the lower temperature and to check the food after the shortest duration.
- 4) Pre-heat the oven. Do not use the Rapid heat-up function  for this.



### Energy efficiency class

The energy efficiency class is calculated in accordance with EN 60350-1.

Energy efficiency class: A+

Please observe the following advice when testing:

- Use the Gentle bake  programme for testing purposes.
- During testing make sure that only those accessories required for the test are in the oven cavity.  
Do not use other accessories that might be available, such as FlexiClip runners or catalytic enamelled panels such as side panels or roof liners.
- When calculating the Energy efficiency class it is important to keep the oven door firmly closed.  
Depending on test instruments used, the door seal function can be affected to a greater or lesser degree. This can have a negative influence on test results.  
This can be compensated for by pressing on the door. Where necessary suitable technical measures can be used to assist. The door seal is not affected in normal everyday use.

### Data sheets for household ovens

The data sheets apply to models described in this operating instruction manual.

# Note for test institutes

---

## Data sheet for household ovens

In acc. with delegated regulation (EU) No. 65/2014 and regulation (EU) No. 66/2014

<b>MIELE</b>	
<b>Model name / identifier</b>	H2265BP; H2267BP
Energy efficiency index/cavity (EEI <sub>cavity</sub> )	81,9
Energy efficiency class/cavity	
A+++ (most efficient) to D (least efficient)	A+
Energy consumption per cycle for each cavity in conventional mode	1,10 kWh
Energy consumption per cycle for each cavity in fan-forced convection mode	0,71 kWh
Number of cavities	1
Heat source(s) per cavity	electric
Volume of cavity	76 l
Mass of the appliance	46 kg

## United Kingdom

Miele Co. Ltd.  
Fairacres, Marcham Road  
Abingdon, Oxon, OX14 1TW  
Customer Contact Centre Tel: 0330 160 6600  
E-mail: mielecare@miele.co.uk  
Internet: www.miele.co.uk

## Australia

Miele Australia Pty. Ltd.  
ACN 005 635 398  
ABN 96 005 635 398  
1 Gilbert Park Drive, Knoxfield, VIC 3180  
Tel: 1300 464 353  
Internet: www.miele.com.au

## China

Miele (Shanghai) Trading Ltd.  
1-3 Floor, No. 82 Shi Men Yi Road  
Jing' an District  
200040 Shanghai, PRC  
Tel: +86 21 6157 3500, Fax: +86 21 6157 3511  
E-mail: info@miele.cn, Internet: www.miele.cn

## Miele (Hong Kong) Limited

41/F - 4101, Manhattan Place  
23 Wang Tai Road  
Kowloon Bay, Hong Kong  
Tel: (852) 2610 1025, Fax: (852) 3579 1404  
Email: customerservices@miele.com.hk  
Website: www.miele.hk

## India

Miele India Pvt. Ltd.  
Ground Floor, Copia Corporate Suites  
Plot No. 9, Jasola, New Delhi - 110025  
Tel: 011-46 900 000, Fax: 011-46 900 001  
E-mail: customercare@miele.in, Internet: www.miele.in

## Ireland

Miele Ireland Ltd.  
2024 Bianconi Avenue  
Citywest Business Campus, Dublin 24  
Tel: (01) 461 07 10, Fax: (01) 461 07 97  
E-Mail: info@miele.ie, Internet: www.miele.ie

## Manufacturer: Miele & Cie. KG

Carl-Miele-Straße 29, 33332 Gütersloh, Germany

# Miele

## Malaysia

Miele Sdn Bhd  
Suite 12-2, Level 12  
Menara Sapura Kencana Petroleum  
Solaris Dutamas No. 1, Jalan Dutamas 1  
50480 Kuala Lumpur, Malaysia  
Phone: +603-6209-0288  
Fax: +603-6205-3768

## New Zealand

Miele New Zealand Limited  
IRD 98 463 631  
Level 2, 10 College Hill  
Freemans Bay, Auckland 1011, NZ  
Tel: 0800 464 353  
Internet: www.miele.co.nz

## Singapore

Miele Pte. Ltd.  
163 Penang Road  
# 04 - 03 Winsland House II  
Singapore 238463  
Tel: +65 6735 1191, Fax: +65 6735 1161  
E-Mail: info@miele.com.sg  
Internet: www.miele.sg

## South Africa

Miele (Pty) Ltd  
63 Peter Place, Bryanston 2194  
P.O. Box 69434, Bryanston 2021  
Tel: (011) 875 9000, Fax: (011) 875 9035  
E-mail: info@miele.co.za  
Internet: www.miele.co.za

## United Arab Emirates

Miele Appliances Ltd.  
Gold & Diamond Park  
Office No. 6-217, Sheikh Zayed Road  
P.O. Box 11 47 82 - Dubai  
Tel. +971 4 3044 999  
Fax. +971 4 3418 852  
800-MIELE (64353)  
E-Mail: info@miele.ae  
Website: www.miele.ae

H2265BP; H2267BP



en-GB

M.-Nr. 10 634 330 / 00