

**Indesit Company S.p.A.**  
Viale Aristide Merloni, 47  
60044 Fabriano (AN)



# Contents

Safety.....	03
Features.....	05
Product Description.....	07
Installation.....	09
Door Handles.....	14
Making Minor Adjustments between doors.....	15
Operation.....	16
Cleaning and Maintenance.....	18
Solutions to Problems.....	19

## **FFUXL4D K** **FFUXL4D**



## **Attention**

---

The refrigerator you have just purchased may be slightly different from the one shown in the drawings in this manual, but its overall design is the same.

Please read the information referring to its operation. This refrigerator is intended for domestic use only.

The plug on the refrigerator you have purchased may be different from the one shown in the manual, as the plug that accompanies the product meets your country's electrical specifications.

# Safety

## For children

Please keep children from entering or climbing the refrigerator to avoid locking the children inside the refrigerator and hurting them when the refrigerator falls.

Do not let the children near the refrigerator when open and close the doors.

This appliance can be used by children aged from 8 years and above and persons with reduced physical, sensory or mental capabilities or lack of experience and knowledge if they have been given supervision or instruction concerning use of the appliance in a safe way and understand the hazards involved. Children shall not play with the appliance. Cleaning and user maintenance shall not be made by children without supervision.”

## Attention

**WARNING:** The refrigerator must be disconnected from the source of electrical supply before attempting the installation of accessory.

**WARNING:** Don't use mechanical equipment or other methods to accelerate the defrosting process except the means recommended by the manufacturer.

**WARNING:** Don't use any electrical appliances in the food storage compartments except the model recommended by the manufacture.

**WARNING:** The R600a refrigerant and cyclopentane foaming material used in the refrigerator are inflammable. All waste and discarded refrigerators shall be placed away from naked fire and they are not allowed to burn.

**WARNING:** Keep ventilation openings, in the appliance enclosure or in the built in structure, clear of obstruction

### Correct Disposal of this product



#### Correct Disposal of this product

This marking indicates that this product should not be disposed with other household wastes throughout the EU. To prevent possible harm to the environment or human health from uncontrolled waste disposal, recycle it responsibly to promote the sustainable reuse of material resources. To return your used device, please use the return and collection systems or contact the retailer where the product was purchased. They can take this product for environmental safe recycling.



## **For the user**

Never pull out the plug by pulling the power cable. Always hold the plug and pull it out from the socket. Don't have the power cable pressed under the refrigerator or feet. When the refrigerator is moved away from the wall, never press or damage the power cable. When the power cable is damaged or the plug is worn, don't use it anymore. When the power cable is worn or damaged, you must change it at the repair station designated by the manufacturer.

When coal gas or other inflammable gases are leaked, close the valve for leaking gases. Open the door and windows. Don't pull out or insert the plug of refrigerator or other electric appliances.

Don't put inflammable, explosive, volatile or strongly corrosive substances into the refrigerator to avoid damaging the refrigerator or starting fire or other accidents.

Don't use inflammable solvent near the refrigerator to avoid fire.

It is advisable that you don't put the power socket, voltage stabilizer, microwave oven and other electric appliances on top of refrigerator to ensure safety. Don't use any electric appliances inside the refrigerator (except for the model recommended) to avoid electromagnetic interference or other accidents.

When the refrigerator starts to work, don't touch the cold surface of the freezer compartment, especially with wet hands, to avoid hurting.

The gap between doors and between the door and refrigerator body is small. Don't put your hands into these areas to avoid finger squeeze. When you open the refrigerator's door, don't let children approach.

Don't sprinkle water onto or rinse the refrigerator with water. Don't put the refrigerator in wet or easy-to-sprinkle places so as not to influence the electric insulation property of the refrigerator.

Don't disassemble or reform the refrigerator by yourself. Never damage the refrigeration pipeline. Please get the refrigerator repaired by professionals.

Don't put fluid substances in bottles or sealed containers into the freezer, like bottled beer or drinks to avoid that the explosive cracking during freezing causes other losses.

When power outage or cleaning, pull out the plug. Turn on the power supply after at least five minutes to avoid that repeated startup might damage the compressor.

When the refrigerator is out of service, please take down the refrigerator's door, remove the door seal and shelves and put them at proper places to avoid that children might play inside and cause accident.

This product is a household refrigerator and is only suitable for storage of food according to state standards. It can't be used for other purposes, like storage of blood, drugs, biological products and etc.

## **Transport and Placing of Your Refrigerator**

### Transport

Keep upright and avoid squeezing or vibration during transport. Avoid a slant angle over 45 degree during handling.

Avoid the door or top cap from being under excessive stress when moving; otherwise, it may become deformed.

### **Placing**

Place your refrigerator in a well-ventilated place and keep it from heat source and direct sunlight. Don't place it in any humid or wet place so as to avoid rust and weakening of insulation effect.

There shall be a space not less than 30cm from the top of your refrigerator and not less than 10cm from both sides or the back of the refrigerator to the adjacent walls respectively . requirement is good for open and close of the door and also for heat emission.

The refrigerator shall be placed on a flat and firm ground (if not flat, you can use the leveling legs foradjustment).

### **Keep Your Refrigerator Standing**

Don't connect your refrigerator to the power supply immediately after it isplaced vertically .You should keep it standing for at least 6 hours before switching it on in order to ensure it running well.

Make sure the power wire is not pinned by the refrigerator or other objects so as to avoid accidents arising from power wire faults. Please check the voltage scope of your refrigerator against the actual power supply before switching it on.

# Cleaning and maintenance

## Refrigerator's maintenance and repair

### Cleaning

Clean regularly dust from the back of refrigerator and ground.

Clean regularly the space inside the refrigerator to avoid any unpleasant smell.

Before cleaning, pull out the plug and use soft towels and neutral detergent and clean it finally with clear water. It is recommended to clean once half a year.

### **Never use following substances to clean the space inside the refrigerator:**

Alkaline or weakly alkaline detergent (it might cause cracking of the liner and plastic parts).

Soap powder, benzoline, thinner, alcohol and etc (might damage plastic parts).

Wipe off edible oil or flavoring immediately (might cause cracking of plastic parts)

### Lights and replacement

Replace by professionals.

### Refrigerator compartment keep fresh with optical wave (only some models)

Keep fresh with optical wave--- use the optical-wave lamp to maintain the Photosynthesis of fruit and vegetables, prolong the growth period and keep it fresh effectively.

### Shutdown

When the refrigerator isn't used for a long period:

Pull out the power cable to avoid that the power cable gets old and causes electric shock or fire.

Clean the space inside the refrigerator

Open the door for a period for drying, close the door with a gap left to avoid unpleasant odor.

### Power outage

Reduce the times of door opening during power outage, don't put fresh food inside the refrigerator anymore.

### Disposal

When you discard an unused refrigerator, remove the door seal to avoid locking children inside the refrigerator.

### Danger

Risk of child entrapment. Before you throw away your old refrigerator or freezer:

1. Take off the doors.
2. Leave the shelves in place so that children may not easily climb inside.

# Product description

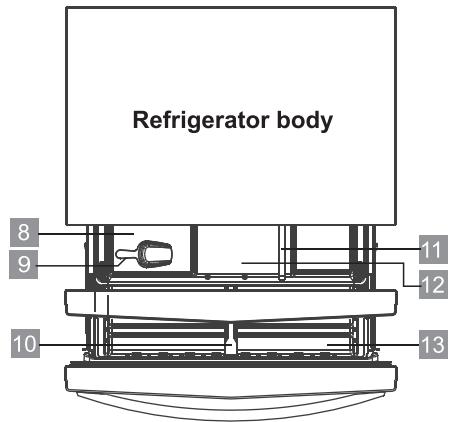
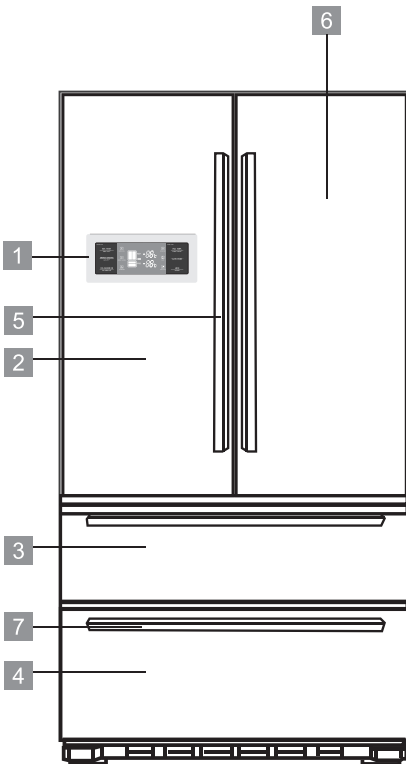

- 1 Display
- 2 Left door for refrigerator compartment
- 3 Upper door for freezer compartment
- 4 Lower door for freezer compartment
- 5 Door handle
- 6 Right door for refrigerator compartment
- 7 Drawer handle

- 8 Manual ice maker
- 9 Ice scoop
- 10 Partition plate for lower freezer drawer
- 11 Partition plate for upper freezer drawer
- 12 Upper freezer drawer
- 13 Lower freezer drawer

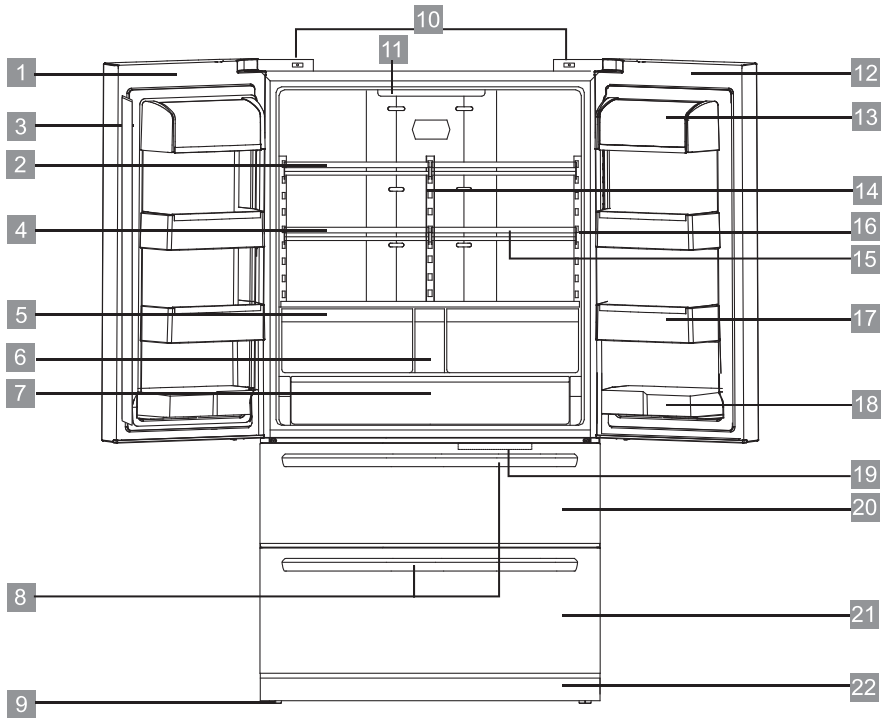

- |   |  |
|---|--|
| 1 Left door for refrigerator compartment    | 12 Right door for refrigerator compartment |
| 2 Cantilever rack                           | 13 Butter box                              |
| 3 Turnover beam                             | 14 Air duct cover plate                    |
| 4 Sliding cantilever rack                   | 15 Folded cantilever rack                  |
| 5 Fruit and vegetable drawer                | 16 Side lamp for refrigerator compartment  |
| 6 Small drawer                              | 17 Gallon bottle rack (With egg bracket)   |
| 7 Big drawer                                | 18 Special-shaped bottle rack              |
| 8 Drawer handle                             | 19 Top lamp for freezer compartment        |
| 9 Leveling leg                              | 20 Upper door for freezer compartment      |
| 10 Switch for refrigerator compartment lamp | 21 Lower door for freezer compartment      |
| 11 Top lamp for refrigerator compartment    | 22 Decorative cover for bottom beam        |

## Installation

Remove all packaging material before using the new refrigerator. This includes the foam base and all adhesive tape holding the refrigerator accessories inside and outside.

Clean both the inside and outside of the refrigerator with wet cloth (a little detergent could be added into the warm water to wash the cloth and then wipe it again with the clean water);

Prepare an independent two-pole socket with grounding contact for the refrigerator and it shall not share a multi-purpose socket with other electrical appliances;

Do connect grounding wire! The grounding pole of the socket shall be provided with a reliable grounding wire.

Open the refrigerator body and take out the accessory (decorative cover for bottom beam) and the three screws from the instruction packaging bag; then install them into the bottom beam as shown by the schematic diagram on the right.

The decorative cover for bottom beam is used as ornament, so you can choose not to install it. It won't affect the refrigerator's performance or conditions no matter whether you install it or not.

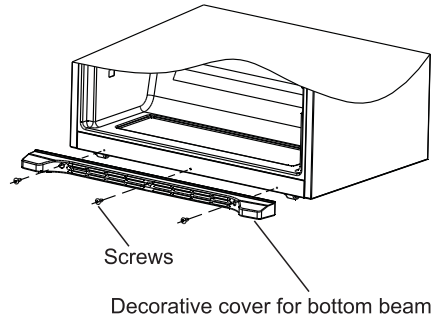

## Start to Use

You ought to get a good knowledge of all safety precautions and make sure that your refrigerator has been placed properly in its final position before using.

### 1. Unpacking

Please install the decorative cover for bottom beam onto your refrigerator after unpacking and adjust the front leveling legs to level your refrigerator.

### 2. Connecting Your Refrigerator to the Power Supply

Your refrigerator will enter the ex-factory default state after connecting to the power supply and it will display target temperature for the refrigerator compartment and freezer compartment.

### 3. Work Modes of Your Refrigerator

You can set your refrigerator in either of the following two ways:

*Auto mode:* we suggest you choosing this mode if you have no special requirements. Your refrigerator will work automatically after you chose this mode.

*Manual mode:* You can set the temperature by pressing the temperature adjustment key.

### 4. Put Food into Your Refrigerator

You can put your food into the refrigerator after a period of time (About hours in summer) when the

refrigerator has already fully refrigerated its interior compartments.

Tips: The interior temperature may require a certain period of time to reach balance if the setting temperature is changed or other food is put into the refrigerator. Such a period of time depends on the change to the setting temperature, the surrounding temperature, opening frequency, the amount of the stored food and etc.

## Refrigerator compartment

Though the temperature-adjustable device could keep most of the refrigerator compartment at an average temperature around 2~8C, it fails to preserve the freshness of food for long. As a result, the refrigerator compartment can be used only for shortterm storage.

### Use of turnover beam

Please keep strictly to the warnings on the label of the turnover beam. It is a normal phenomenon that the surface of the turnover beam is hot. Dews on the surface are also normal in summer or when the surrounding environment is wet. What you need to do is to clean them away with cloth.

### Adjustment of cantilever rack

The cantilever rack could be adjusted to the proper height as required by food. Please adjust the cantilever rack by following the arrows as shown in the diagram. Raise it upward first and then take it out by tilting it upward. During installation, put the upper end of the fixed leg into one of the upper slots on the supporting iron first and then put the lower end of the fixed leg into the third slot on the lower part of the supporting iron.

### Height adjustment and cleaning of door-mounted bottle rack

Raise the bottle rack in the direction , hold it with both hands and take it out in the direction . After cleaning, you can install the rack in the reverse order and you can also adjust the height of the rack.

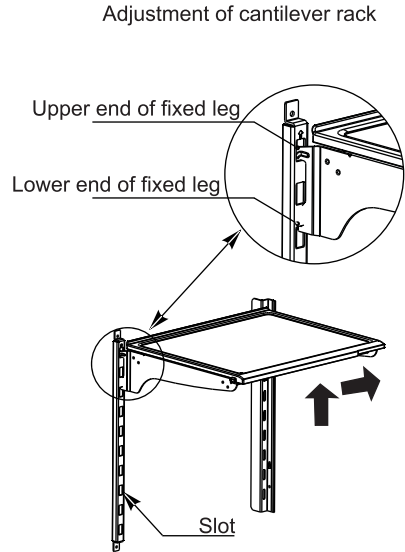

Adjustment of door-mounted bottle rack

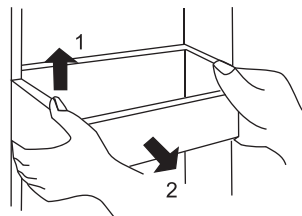



### **Food suggested to store in refrigerator compartment**

1. Cooked wheaten food, cans, milk, etc.
2. Snack food, food subject to tainting, dairy product
3. Cooked cold meat, sausage
4. Fruit, vegetables
5. Eggs, butter, cheese
6. Cans, seasoning
7. Drinks, other bottled food

2. Ice storage box is used to store the ice.
3. The lower drawer of the freezer is used to store fish, meat and packaged poultry meat.

### **Freezer compartment**

The temperature in the freezer compartment is very low so it could preserve the freshness of food for long. Those that shall be stored for long could be put in this compartment but not exceed the storage period specified on the packaging of each kind of food.

You can take out the drawers of the freezer compartment to increase its capacity and store more food.

### **Food suggested to store in freezer compartment**

1. The upper drawer of the freezer could be used to store fish, meat, ice-cream and etc.

## Taking-out and installation of the lower freezer drawer

1. Pull out the lower freezer drawer first.
2. Take out the two fixed screws from the partition plate of the lower freezer drawer with screw driver and then take off the partition plate.
3. Take off the rear stopper for the lower drawer as shown by Fig. A.
4. Take out the lower drawer body with force as directed by the arrows in Fig. B.
5. The installation of the lower drawer body is conducted in the reverse order. You should install the lower drawer body first and then install the rear stopper for the lower drawer as shown in Fig. C. Finally, both sides of the drawer shall be connected to the position shown by the arrows respectively.
6. The partition plate is installed into the corresponding slots and then is fixed with screws. The position of the partition plate for the lower drawer could be adjusted according to your preference.

Don't remove the lower freezer drawer if not necessary.

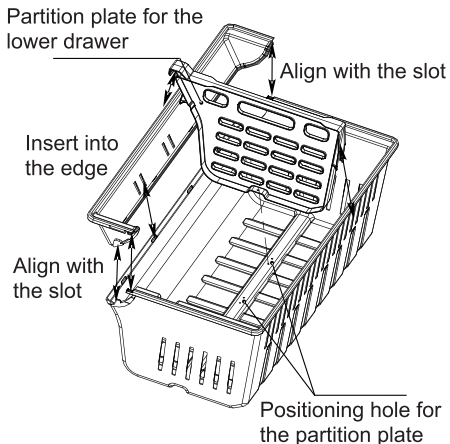
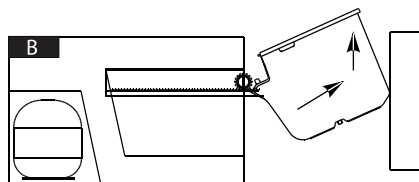
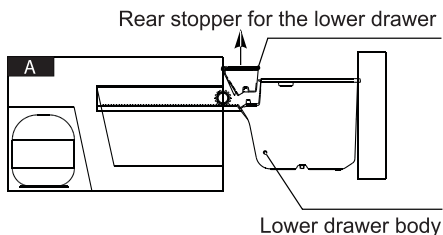

## Big drawer

The big drawer has a maximum load of 10kg.

### Pull out and install the big drawer

1. Pull out the big drawer;
2. Find the hook at the left and right sides at the drawer bottom (shown in the figure).
3. Hold the hook at two sides with a nose pliers or tweezers and push it up and out of the groove of sliding rail, and take out the hook at the other side with the same method.
4. Take out the drawer.
5. Install the drawer by putting the hook into the right place.

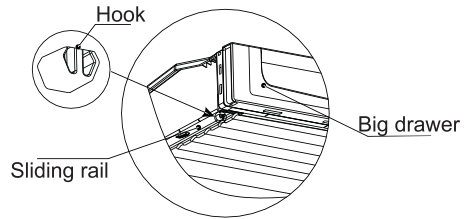

# Door handles

## Assembly instructions of cold storage door handle:

1. Firstly, take the handle set bolts out from the refrigerator, use cross recessed screwdriver to set the bolt on the door. Fix it tight with all the screw thread twisted through the hole, as shown in the figure;
2. After the first step is completed, take the Cold storage door handle out from the box, place it as per the direction shown in the figure (Note: i.e. the direction which both screw holes on the handle are close to the edge), and hang the handle above the set bolt;
3. Use the small hexagon spanner supplied in the box to set the handle fixing socket head cap screws into both the small screwed holes on the handle. After they are screwed down, gently shake the handle, so as to confirm that the handle is well erected.

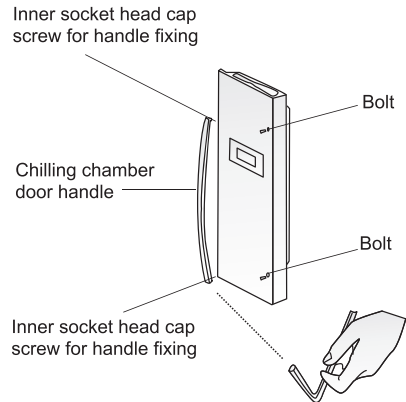

## Scheme of installation of cold storage door handle

Difference between the chilling and refrigeration handle: lie them flat, the one with higher chordal height is the refrigeration handle

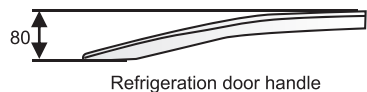

## Assembly instructions of the refrigeration door handle:

The assembly steps of the refrigeration door handle is same with that of the cold storage door handle. Please note that: during the assembly of the handle, the direction of tapping hole is downward (to the ground).

# Making minor adjustments between doors

Remember a level refrigerator is necessary for getting the doors perfectly even. If you need help, review the previous section on leveling the refrigerator.

When the left doors is lower than the right door(left). Or the right doors is lower than the left door.

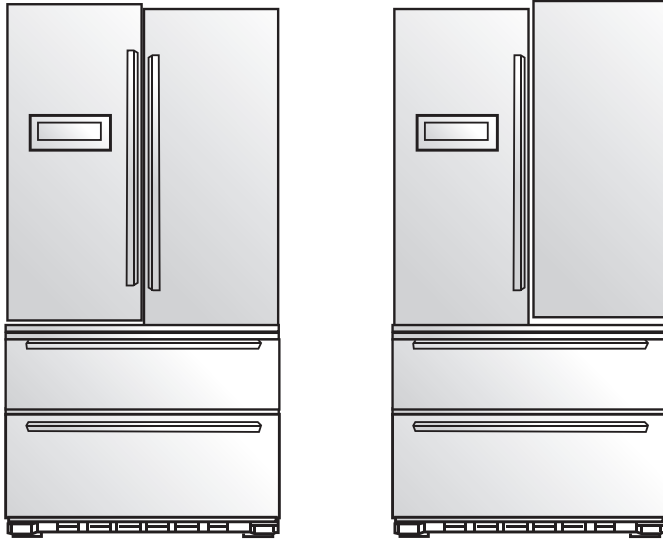

## Do as follows

- 1) Raise the left door or the right door.
- 2) Insert the supplied fastener-ring (2) using a pair of pliers (3) in the gap between the hinge-grommet (1) and the lower hinge (4). The number of fasteners you will need to insert depends on the gap.

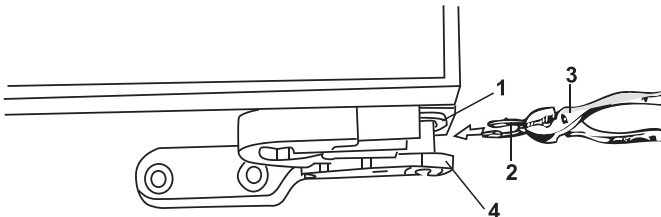

## Introduction of Your Refrigerator's Functions

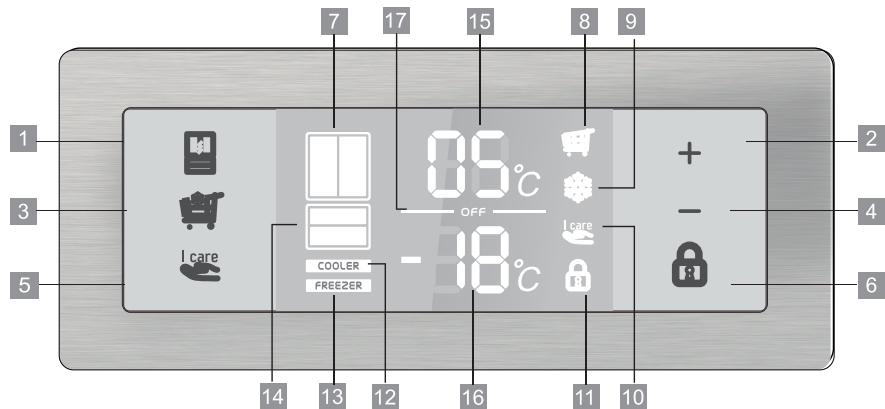

### Control buttons

- |                       |                   |                      |
|-----------------------|-------------------|----------------------|
| 1 Temperature control | 3 Super cool mode | 5 Energy saving mode |
| 2 “^”                 | 4 “v”             | 6 Child Lock         |

### Display items

- |                                 |                             |   |
|---------------------------------|-----------------------------|---|
| 7 Refrigerator compartment icon | 11 Locked icon              | 15 Refrigerator temperature               |
| 8 Fast-cooling icon             | 12 Refrigerator indicate    | 16 Freezer temperature                    |
| 9 Fast-freezing icon            | 13 Freezer indicate         | 17 Off icon: means refrigerator shut down |
| 10 Energy-saving icon           | 14 Freezer compartment icon |   |

### Initial power-on status

11, 12, 14, 15 and 16 turn on at initial power-up. 8, 9, 10, 13 and 17 do not turn on.

### Locking and unlocking

In the unlock state (icon 11 does not turn on), push the key 6 to enter the lock state and icon 11 turns on. In the lock state, push and hold the key 6 for 3 seconds, icon 11 turns off and the lock is cancelled. In the unlock state, in case of no other input of any pushing after 25 seconds, it enters the lock state automatically.

The below functions can be performed while in the “Unlocked” status.

## Introduction of Your Refrigerator's Functions

---

### Energy saving mode

**Entry:** push the key 5, the icon 10 turns on. Choose the energy-saving mode to operate the refrigerator, and the mode operated before will be cancelled.

**Exit:** ① enter other modes ② push the key 2 or 4 to the set temperature ③ push the key 5. When each condition mentioned above occurs, the refrigerator exits the energy-saving mode.

### Fast-cooling mode

**Entry:** push the key 3, the icon 8 turns on. Choose the quick cooling mode to operate the refrigerator. If the refrigerator is operating in the energy saving mode, the energy saving mode exits.

**Exit:** ① enter the energy saving mode ② push the key 2 or 4 to the set temperature ③ push the key 3. When each condition mentioned above occurs, the refrigerator exits the quick cooling mode.

### Fast-freezing mode

**Entry:** push and hold the key 3 for 3 seconds, the icon 9 turns on. Choose the quick-freeze mode to operate the freezer. If the freezer is operating in the energy-saving mode, the energy-saving mode exits.

**Exit:** ① enter the energy-saving mode ② push the key 2 or 4 ③ push and hold the key 3 for 3 seconds. When each condition mentioned above occurs, the quick-freeze mode exits.

### To set the temperature of the refrigerator compartment

Push the key 1 until the display changes to refrigerator temperature setting. The icon 124 turns on. Push the key 2 or 4 once, and the refrigerator setting temperature changes 1°C according to the regulation of “(8)-(2)-(8)” .

### To set the temperature of the freezer compartment

Push the key 1 until the display changes to the freezer temperature setting. The icon turns on. Push the key 2 or 4 once, and the freezer setting temperature changes 1°C according to the regulation of “(-15)- (-24)- (-15)”

### Backlight action

When the refrigerator/ freezer door is open or any button is pressed, the Function Display Screen will become illuminated. If no button is pressed and the refrigerator/freezer door has remained open for 30 seconds, the Function Display will turn off.

# Solutions to problems

**Please read the following contents before repair request:**

Ocurrence	Possible cause / inspection itens
Not working	Whether the power is switched on, whether the plug is secured? Whether the voltage is too low?
Can't freeze properly	Whether the temperature is set too high (might reduce the temperature as required). ? Whether too much food is stored? Whether hot foot is stored? Whether the door is opened and closed too frequently? Whether there is hot source around the refrigerator? Whether the door seal is closed?
Loud noises	Whether the ground is leveled and the refrigerator is placed on leveled ground? Whether accessories of the refrigerator are put at the right position?
Food is frozen inside the refrigerator compartment.	Whether the food is put near the air outlet?
The refrigerator has unpleasant smell	Food with special odor shall be tightly wrapped. Check whether the food has gone bad. Clean inside the refrigerator.

If the situation doesn't turn better after you have checked all above items, please contact with the after-sales Service Centers. If power cables are damaged, please get it changed by the repairmen designated by our Service Centers to avoid any risk.

## **Normal phenomena not regarded as malfunctioning**

Refrigerant inside the capillary tubes of the refrigerator flow in high speed and might have a few amount of bubbles. Hence, irregular noises might appear at the outlet.







When the air humidity is excessively high, moisture or water droplets might appear around the refrigerator's door. You just need to wipe it off.

## **No extension cord used**



GB - model

GB - serial number

Indesit Company				 Sertifikat					
Mod.		<b>FFUXL4D</b>		00849020000		S/N 303080001			
		220-240V~		50Hz 1.1A		defrost heater 270W		wattage of lamp 3.3W	
Total vol.	Gross	570 L			Freez.	Capac	Class		
	Net	542 L			10kg/24h	Classe		N-ST	
	Refr	422 L							
	Freez	120 L							
R600a	Refr.	0.087 kg.							
	Freez	kg.							
Made In China									