

# Panasonic®

## Operating Instructions

### DVD Recorder

Model No. **DMR-EX97**

# DIGA



Thank you for purchasing this product.

Please read these instructions carefully before using this product, and save this manual for future use.

#### Software (Firmware) Update



To support the latest features, it's very important you install the latest updates to maintain proper operation of your unit.

For details, refer to "Software (Firmware) Update" (⇒ 68) or  
<http://panasonic.jp/support/global/cs/> (This site is in English only.)

Model number suffix "EB" denotes UK model.

# Safety precautions

## WARNING

### Unit

- To reduce the risk of fire, electric shock or product damage,
  - Do not expose this unit to rain, moisture, dripping or splashing.
  - Do not place objects filled with liquids, such as vases, on this unit.
  - Use only the recommended accessories.
  - Do not remove covers.
  - Do not repair this unit by yourself. Refer servicing to qualified service personnel.
  - Do not let metal objects fall inside this unit.
  - Do not place heavy items on this unit.

### AC mains lead

- To reduce the risk of fire, electric shock or product damage,
  - Ensure that the power supply voltage corresponds to the voltage printed on this unit.
  - Insert the mains plug fully into the socket outlet.
  - Do not pull, bend, or place heavy items on the lead.
  - Do not handle the plug with wet hands.
  - Hold onto the mains plug body when disconnecting the plug.
  - Do not use a damaged mains plug or socket outlet.
- The mains plug is the disconnecting device. Install this unit so that the mains plug can be unplugged from the socket outlet immediately.

## CAUTION

### Unit

- This unit utilizes a laser. Use of controls or adjustments or performance of procedures other than those specified herein may result in hazardous radiation exposure.

- Do not place sources of naked flames, such as lighted candles, on this unit.
- This unit may receive radio interference caused by mobile telephones during use. If such interference occurs, please increase separation between this unit and the mobile telephone.
- This unit is intended for use in moderate climates.

### Placement

- Place this unit on an even surface.
- To reduce the risk of fire, electric shock or product damage,
  - Do not install or place this unit in a bookcase, built-in cabinet or in another confined space. Ensure this unit is well ventilated.
  - Do not obstruct this unit's ventilation openings with newspapers, tablecloths, curtains, and similar items.
  - Do not expose this unit to direct sunlight, high temperatures, high humidity, and excessive vibration.

### Batteries

- Danger of explosion if battery is incorrectly replaced. Replace only with the type recommended by the manufacturer.
- Mishandling of batteries can cause electrolyte leakage and may cause a fire.
  - Do not mix old and new batteries or different types at the same time.
  - Do not heat or expose to flame.
  - Do not leave the battery(ies) in a car exposed to direct sunlight for a long period of time with doors and windows closed.
  - Do not take apart or short circuit.
  - Do not recharge alkaline or manganese batteries.
  - Do not use batteries if the covering has been peeled off.
  - Remove batteries if you do not intend to use the remote control for a long period of time. Store in a cool, dark place.
- When disposing of the batteries, please contact your local authorities or dealer and ask for the correct method of disposal.



# Caution for AC Mains Lead

## (For the AC mains plug of three pins)

For your safety, please read the following text carefully.

This appliance is supplied with a moulded three pin mains plug for your safety and convenience. A 5-ampere fuse is fitted in this plug.

Should the fuse need to be replaced please ensure that the replacement fuse has a rating of 5-ampere and that it is approved by ASTA or BSI to BS1362.

Check for the ASTA mark  or the BSI mark  on the body of the fuse.

If the plug contains a removable fuse cover you must ensure that it is refitted when the fuse is replaced.

If you lose the fuse cover the plug must not be used until a replacement cover is obtained. A replacement fuse cover can be purchased from your local dealer.

### Before use

Remove the connector cover.

### How to replace the fuse

The location of the fuse differ according to the type of AC mains plug (figures A and B). Confirm the AC mains plug fitted and follow the instructions below.

Illustrations may differ from actual AC mains plug.

1. Open the fuse cover with a screwdriver.

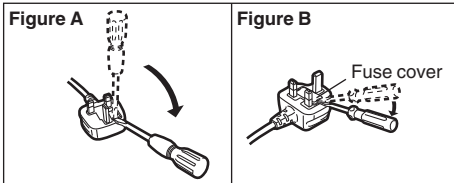

2. Replace the fuse and close or attach the fuse cover.

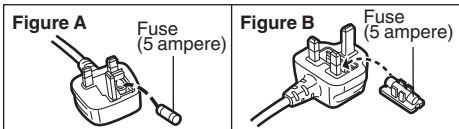

# Supplied accessories

Please check and identify the supplied accessories.

(Product numbers are correct as of August 2015. These may be subject to change.)

- Remote control** (N2QAYB001059): 1 pc.
  - Batteries for remote control:** 2 pcs.
  - AC mains lead** (K2CT2YY00098): 1 pc.
  - RF coaxial cable** (K2KYYYY00247): 1 pc.
  - HDMI cable** (K1HY19YY0011): 1 pc.
- Do not use AC mains lead with other equipment.

### Insert batteries

Insert so the poles (+ and -) match those in the remote control.

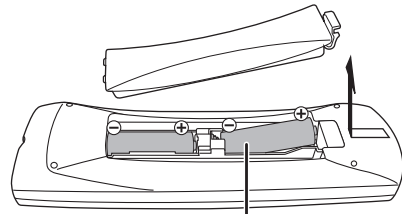

R6/LR6, AA  
(Alkaline or manganese batteries)

### About descriptions in these operating instructions

- Pages to be referred to are indicated as "⇒ ○○".

# Table of contents

Safety precautions	2
Caution for AC Mains Lead	3
Supplied accessories	3

## Getting started

---

HDD and media information	6
Unit care	11
Control reference guide	12
Connection	14
Settings	16
FUNCTION MENU screen	18

## Watching broadcasts

---

Watching broadcasts	19
---------------------	----

## Recording

---

Recording TV programmes	22
Timer recording	24

## Playing back video

---

Playing titles on the HDD	29
Playing titles on the media	32
Operation during play	33

## Editing video

---

Deleting/Editing titles	36
-------------------------	----

## Copying video

---

Copying titles	40
----------------	----

## Photo and Music

---

Playing photos	48
Editing photos	50
Copying photos	51
Playing music	52
Copying/Deleting music	53

## With Other Equipment

---

Copying the HD Video (AVCHD)	54
Registering the external HDD (USB HDD)	55

## Convenient functions

---

VIERA Link functions	57
Playback menu	58
Basic Settings	60
Software (Firmware) Update	68
Other operations	69

## Troubleshooting

---

Troubleshooting guide	72
-----------------------	----

## Reference

---

Specifications	78
Reference	80
Licenses	81
Index	82

**Getting started**

**Watching broadcasts**

**Recording**

**Playing back video**

**Editing video**

**Copying video**

**Photo and Music**

**With Other Equipment**

**Convenient functions**

**Troubleshooting**

**Reference**

# HDD and media information





For more details, refer also to the specifications. (⇒ 78)

## Recordable/playable contents

(-: Impossible)

Media type	Standard symbol		Recordable contents	Playable contents
<b>Built-in hard disk drive (HDD)</b>		<b>HDD</b>	<ul style="list-style-type: none"> <li>• Video</li> <li>• AVCHD/AVCHD 3D</li> <li>• JPEG</li> <li>• MPO (3D photo)</li> </ul>	<ul style="list-style-type: none"> <li>• MP4</li> <li>• MPEG2</li> <li>• Xvid</li> <li>• MKV</li> <li>• AAC</li> <li>• MP3</li> </ul>
<b>External hard disk drive (USB HDD) (⇒ 9)</b>		<b>USB HDD</b>	<ul style="list-style-type: none"> <li>• Video<sup>#1</sup></li> </ul>	<ul style="list-style-type: none"> <li>• AVCHD/AVCHD 3D<sup>#2,3</sup></li> <li>• MP4</li> <li>• MPEG2</li> <li>• Xvid</li> <li>• MKV</li> <li>• JPEG</li> <li>• MPO (3D photo)</li> <li>• AAC</li> <li>• MP3</li> </ul>
<b>DVD-Video<sup>#4</sup></b>		<b>DVD-V</b>	–	<ul style="list-style-type: none"> <li>• Video</li> </ul>
<b>DVD-RAM</b>		<b>RAM</b>	<ul style="list-style-type: none"> <li>• Video</li> <li>• JPEG</li> <li>• MPO (3D photo)</li> </ul>	<ul style="list-style-type: none"> <li>• AVCHD<sup>#2</sup></li> </ul>
			–	
<b>DVD-R</b> <b>DVD-R DL</b>		<b>DVD-R</b>	<ul style="list-style-type: none"> <li>• Video</li> <li>• AVCHD<sup>#2</sup></li> </ul>	<ul style="list-style-type: none"> <li>• Xvid</li> <li>• MKV</li> <li>• JPEG</li> <li>• MPO (3D photo)</li> <li>• AAC</li> <li>• MP3</li> </ul>
			–	
<b>DVD-RW</b>		<b>DVD-RW</b>	<ul style="list-style-type: none"> <li>• Video</li> </ul>	<ul style="list-style-type: none"> <li>• AVCHD<sup>#2</sup></li> <li>• Xvid</li> <li>• MKV</li> <li>• AVCHD<sup>#2</sup></li> <li>• JPEG</li> <li>• MPO (3D photo)</li> <li>• AAC</li> <li>• MP3</li> </ul>
			–	
<b>+R/+R DL</b>			–	
<b>+RW</b>		<b>+RW</b>	<ul style="list-style-type: none"> <li>• Video</li> </ul>	<ul style="list-style-type: none"> <li>• AVCHD<sup>#2</sup></li> </ul>
			–	

(-: Impossible)

Media type	Standard symbol		Recordable contents	Playable contents
<b>Audio CD (CD-DA)</b> 			-	• Music
<b>CD (including CD-R/RW)</b>			-	• Xvid • MKV • JPEG • MPO (3D photo) • AAC • MP3
<b>USB memory</b>			-	• AVCHD/AVCHD 3D <sup>#2,3</sup> • MP4 • MPEG2 • Xvid • MKV • AAC • MP3 • JPEG • MPO (3D photo)

- ※1 It cannot be recorded directly. (Only compatible with copying from the built-in HDD)
- ※2 Recorded with AVCHD format compatible devices (Panasonic video camera, etc.). It may not be able to play back, add, or edit depending on the device.
- ※3 It cannot be played back directly from the USB HDD or USB memory. Playback is possible by copying to the built-in HDD. (⇒ 54)
- ※4 Includes finalised DVD-R, DVD-R DL, DVD-RW, +R and +R DL.



- **+RW** This unit cannot record to 8X Speed +RW disc.
- With certain recording states and folder structures, the play order may differ or playback may not be possible.
- It may not be possible to play the above media in some cases due to the type of media, the condition of the recording, the recording method, and how the files were created.

The recording and playback of content on this or any other device may require permission from the owner of the copyright or other such rights in that content. Panasonic has no authority to and does not grant you that permission and explicitly disclaims any right, ability or intention to obtain such permission on your behalf. It is your responsibility to ensure that your use of this or any other device complies with applicable copyright legislation in your country. Please refer to that legislation for more information on the relevant laws and regulations involved or contact the owner of the rights in the content you wish to record or playback.

#### Indemnity concerning recorded content

Panasonic does not accept any responsibility for damages directly or indirectly due to any type of problems that result in loss of recording or edited content (data), and does not guarantee any content if recording or editing does not work properly. Likewise, the above also applies in a case where any type of repair is made to the unit (including any other non-HDD related component).

## HDD and media information

## Information about contents

### ■ Broadcast Recordings

Numbers of titles that can be recorded:

Media	Maximum titles
HDD	1000
DVD-RAM, DVD-R, DVD-RW	99
+R, +RW	49

- Maximum numbers of titles are including recordings of HD CAMCORDER.

### ■ HD CAMCORDER Recordings

MPEG-4 AVC/H.264 (based on AVCHD)

Numbers of titles that can be recorded:

Media	Maximum titles
HDD	1000

- Maximum numbers of titles are including recordings of Broadcast.

### ■ Photo files

Compatible pixels:

Between 34×34 and 8192×8192 pixels

Sub sampling: 4:2:2, 4:2:0  
(Motion JPEG is not supported.)

Maximum numbers of contents:

Media	Folders	Files
HDD	–	20000
DVD-RAM, DVD-R, +R, CD-R, CD-RW, USB device	500	10000

### ■ Video files/Audio files

Numbers of contents that can be copied to internal HDD:

Contents	Maximum numbers of folders and files
Video	20000
Audio	20000

USB device:

- Each folder can store up to 1000 files.
- We recommend that you limit the depth of folder trees to about five levels.

## About extension of files



MP4:	“.mp4”	“.mov”			
MPEG2:	“.mpg”	“.mpeg”	“.m2ts”	“.mts”	“.ts”
Xvid:	“.avi”				
Subtitle text files:	“.srt”	“.sub”	“.txt”		
MKV:	“.mkv”				
Subtitle text files:	“.srt”	“.sub”	“.txt”		
JPEG:	“.jpg”				
MPO:	“.mpo”				
AAC:	“.m4a”				
MP3:	“.mp3”				



- The video file and subtitle text files are inside the same folder, and the file names are the same except for the file extensions.
- Some files may not be played back even if they have these extensions.



## Recording mode

Recording Mode	DR	HG/HX/HE/HL/HM	XP/SP/LP/EP/FR <sup>*1</sup>
<b>Feature</b>	Programmes can be recorded in a nearly perfect broadcasted state.	Recording can be done with reduced recording volume in High definition (HD) quality <sup>*2</sup> .	Recording can be done with reduced recording volume in Standard definition (SD) quality.
<b>Recordable media</b>			
<b>Multiple audio</b>	Record all multiple audio	Record only one audio <sup>*3</sup>	
<b>Audio Description</b>	Can be recorded	Cannot be recorded <sup>*4</sup>	
<b>Subtitles</b>	Can be recorded	Can be recorded (only one subtitle) <sup>*5</sup>	
<b>Surround audio</b>	Surround audio as the broadcast	Stereo audio	

<sup>\*1</sup> FR (Flexible Recording Mode):

The unit automatically selects the best possible recording rate between XP mode and EP mode.

<sup>\*2</sup> The SD quality programme cannot be converted to HD quality.

<sup>\*3</sup> You cannot select during play whether it activates or deactivates.

<sup>\*4</sup> Audio descriptions will be lost after File Conversion is performed.  
Audio descriptions cannot be exported to discs.

<sup>\*5</sup> You cannot select during play whether it appears or disappears.

### Approximate recording times

Refer to "Recording modes and approximate recording times". (⇒ 78)

## Notes

### Notes for the USB device

You can use an external HDD (USB HDD) in the following two ways (A single HDD cannot handle those two ways simultaneously), and a USB memory for data files.

#### • For recorded titles

Moving titles in the built-in HDD to a USB HDD to save the capacity of the built-in HDD.

- The USB HDD must first be registered on this unit. (⇒ 55)
- The USB HDD over 3 TB is not usable.

#### • For data files

Playing back MP4, JPEG, MP3, etc. in a USB device with this unit.

- The USB device must be formatted in FAT12, FAT16, FAT32 or NTFS file system.
- The USB device over 2 TB is not usable.



- This unit supports USB 2.0 High Speed.
- Although this unit can use USB 3.0 devices as USB 2.0 devices.
- This unit does not recognise USB HDDs other than those in which the size of one sector is 512-bytes or 4096-bytes. (For details, consult the dealer of your USB HDD.)
- This unit supports USB mass storage device class.
- This unit does not guarantee connection with all USB devices.

## HDD and media information

### Notes for the disc

#### • Region management information

The unit can play back DVD-Video discs of the following regions codes, including "ALL":

e.g.,



#### • Disc recorded on another device

- It may be necessary to finalise the disc, create Top Menu or close the session on the equipment used for recording to play on this unit.
- **DVD-RW** Recorded in DVD Video Recording (DVD-VR) format
  - This unit can play back and copy to HDD.
  - This unit does not support editing or recording.
  - It is possible to record and edit with DVD-Video (DVD-V) format by formatting discs with this unit.
- Recording may not be possible to discs which were used for recording on other equipment.

#### • Play on other players

- **DVD-R** **DVD-RW** **+R** Finalisation is needed. (⇒ 70)
- **+RW** If the disc failed to play on other equipment, we recommend you create a Top Menu (⇒ 70).
- **DVD-R** The disc created in AVCHD format can only be played back on AVCHD compatible equipment.

#### • Regarding 8 cm Disc

This unit cannot record or edit the 8 cm disc. Only playback or copy to the HDD is possible.

#### • Discs that cannot be played

- Blu-ray Disc
- DVD-RAM in a cartridge
- 2.6 and 5.2 GB DVD-RAM, 12 cm
- DVD-Audio
- Super Video CD, Super Audio CD, Video CD



- Operation and sound quality of CDs that do not conform to CD-DA specifications (copy control CDs, etc.) cannot be guaranteed.

### Media handling

- Do not touch the recorded surface of the discs.
- Wipe with a damp cloth and then wipe dry.



- Do not attach labels or stickers to discs.
- Do not use disc cleaning sprays, benzene, thinner, static electricity prevention liquids or any other solvent.
- Do not use the following discs:
  - Discs with exposed adhesive from removed stickers or labels (rental discs, etc.).
  - Discs that are badly warped or cracked.
  - Irregularly shaped discs, such as heart shapes.

# Unit care

## HDD/USB HDD handling care

- The HDD is a high precision recording instrument and is easily susceptible to damage. Therefore, be careful of the following points while the unit is turned on, especially during operation, otherwise the HDD and the recorded content may be damaged:
  - Do not subject the unit to any vibration and shock.
  - Do not remove the AC mains lead from the household mains socket.
- **The HDD is a temporary storage device**
  - It is recommended to save the recorded content on a disc or to keep the original data or CDs that they were copied from.
  - If you notice a problem with the HDD such as repetitive strange sounds, immediately save (backup) all content and request service. If you continue using the HDD with a problem, the unit or the recorded content will be damaged.
- **If the HDD or USB HDD is damaged, the recorded content cannot be recovered.**

## Setup precautions

- **Do not place on anything that generates heat like a Set Top Box, etc.**
- **Place in an area where condensation does not occur. Conditions where condensation may occur**
  - When there is an extreme change in temperature (e.g., when subjected to an air conditioner or when cooled air directly impacts the unit).
  - When there is high humidity or a lot of steam in the room.

In the above situation, **without turning the unit on**, let the unit adjust to the room temperature and wait 2–3 hours until condensation is gone.

- **The unit may breakdown if cigarette smoke or bug spray/vapour, etc. gets inside the unit.**

## When moving the unit

Before moving the unit, ensure the disc tray is empty.

- 1 Switch the unit to standby mode. (Wait until "BYE" disappears from the display.)
- 2 Remove the AC mains lead from the household mains socket.
- 3 Move only after the unit has come to a complete stop (approx. 3 minutes) in order to avoid subjecting to vibration and shock. (Even after the unit is switched to standby mode, the HDD continues operating for a short time.)

## Cleaning

- Wipe with a soft, dry cloth.
- Never use alcohol, paint thinner or benzine to clean this unit.
- Before using chemically treated cloth, carefully read the instructions that came with the cloth.
- Use the lens cleaner (not supplied) to clean the unit's lens.

## When requesting this unit for repair

The registration of the USB HDD may be cancelled in the process of repairing this unit.

You can use the USB HDD again by re-registering, but all recorded content already on the USB HDD will be lost. In such cases, the recorded content (data) cannot be recovered.

## To dispose or transfer this unit

This unit may contain private information. Before disposing of or transferring this unit, perform the following to delete the data, including personal or secret information:

- Format HDD (⇒ 63)
- Perform "Shipping Condition" (⇒ 67)

# Control reference guide

Instructions for operations are generally described using the remote control.

## Remote control

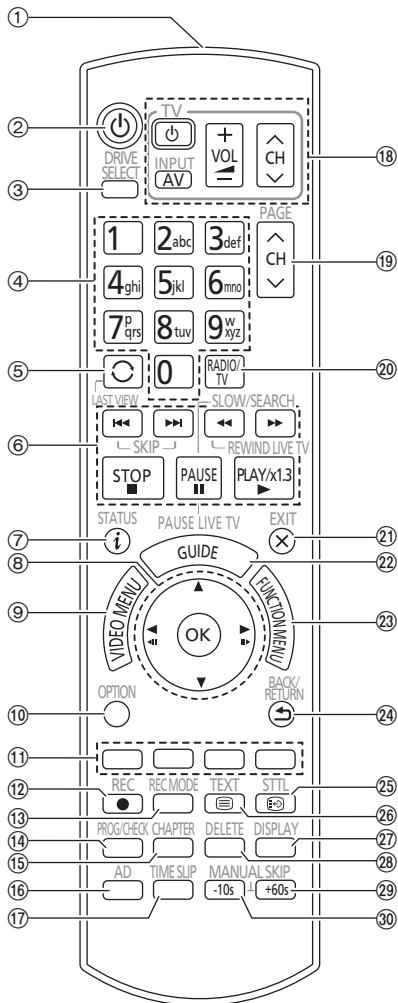

- ① Transmit the remote control signal
  - Point it at remote control signal sensor on this unit. (⇒ 13)
- ② Switch the unit from on to standby mode or vice versa
- ③ Select drive (HDD, Disc or USB)
- ④ Select channels and title numbers, etc./Enter numbers or characters
- ⑤ Switch to the previously watched channel (⇒ 19)
- ⑥ Basic operations for recording and play, REWIND LIVE TV/PAUSE LIVE TV (⇒ 21)
- ⑦ Show Information (⇒ 19, 30, 33)
- ⑧ Selection/OK, Frame-by-frame (⇒ 33)
- ⑨ Show Video Menu (⇒ 29)
- ⑩ Show OPTION menu (⇒ 36, 50)
- ⑪ Colour buttons (Use in accordance with instruction on the screen.)
- ⑫ Start recording (⇒ 22)
- ⑬ Select a recording mode/conversion mode (⇒ 22)
- ⑭ Show the Timer Recording screen (⇒ 26)
- ⑮ Create chapter (⇒ 34)
- ⑯ Listen to Audio Description (⇒ 20, 34)
- ⑰ Skip the specified time (⇒ 34)
- ⑱ TV operation buttons (⇒ 16)
- ⑲ Channel select (⇒ 19)/Change pages in the Video Menu screen etc.
- ⑳ Switching to the radio channel list (⇒ 19)
- ㉑ Exit the menu screen
- ㉒ Show the TV Guide screen (⇒ 20)
- ㉓ Show the FUNCTION MENU screen (⇒ 19)
- ㉔ Return to previous screen
- ㉕ Show subtitles (⇒ 19, 34)
- ㉖ Show Digital Teletext (⇒ 20)
- ㉗ Show Playback Menu (⇒ 58)
- ㉘ To delete unwanted recorded titles, timer programmes, video, photo or music (⇒ 36)
- ㉙ Skip approx. 1 minute forward (⇒ 33)
- ㉚ Skip approx. 10 seconds backward (⇒ 33)

## Main unit

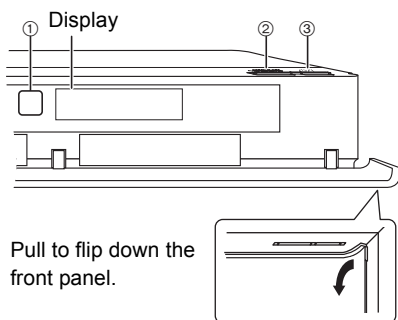

Pull to flip down the front panel.

- ① Remote control signal sensor
  - Angle: Approx. 20° up and down, 30° left and right
  - Distance: Within approx. 7 m in front of the unit
- ② Open/close disc tray
- ③ **Standby/on switch (⏻/⏻)**  
Press to switch the unit from on to standby mode or vice versa. In standby mode, the unit is still consuming a small amount of power.

## Display

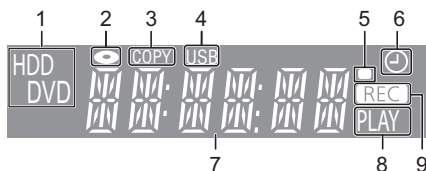

- 1 Drive (HDD or DVD) indicator
- 2 Disc indicator
- 3 Copying indicator
- 4 USB port indicator
- 5 Remote control signal indicator
- 6 Timer recording indicator  
This indicator lights up when the timer recording standby is activated.
- 7 Main display section indicator  
• Messages and other information are displayed. (⇒ 76)
- 8 Playback indicator
- 9 Recording indicator  
• The indicator will light up while recording.  
• The indicator will blink while recording is paused and before recording starts.

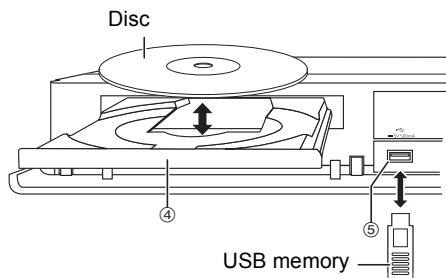

- ④ Disc tray
- ⑤ USB port



- While writing to/reading from the media, do not switch the unit to standby mode or remove the media. Such action may result in loss of the media contents.
- When inserting the media, ensure that it is facing the right way up.

# Connection

3D programmes can be played back when this unit is connected to 3D compatible terminal of a 3D compatible TV.

- Before connection, turn off all equipment and read the appropriate operating instructions.
- If you use an optional HDMI cable, use the High Speed HDMI cables. Non-HDMI-compliant cables cannot be utilized.  
It is recommended that you use Panasonic's HDMI cable.  
When outputting 1080p or 24p signal, please use HDMI cables 5.0 meters or less.  
The HDMI-compliant cable is supplied with this unit.
- When the unit is not to be used for a long time  
To save power, unplug it from the household mains socket. This unit consumes a small amount of power, even when the unit is in standby mode. (⇒ 78)

## Basic connections

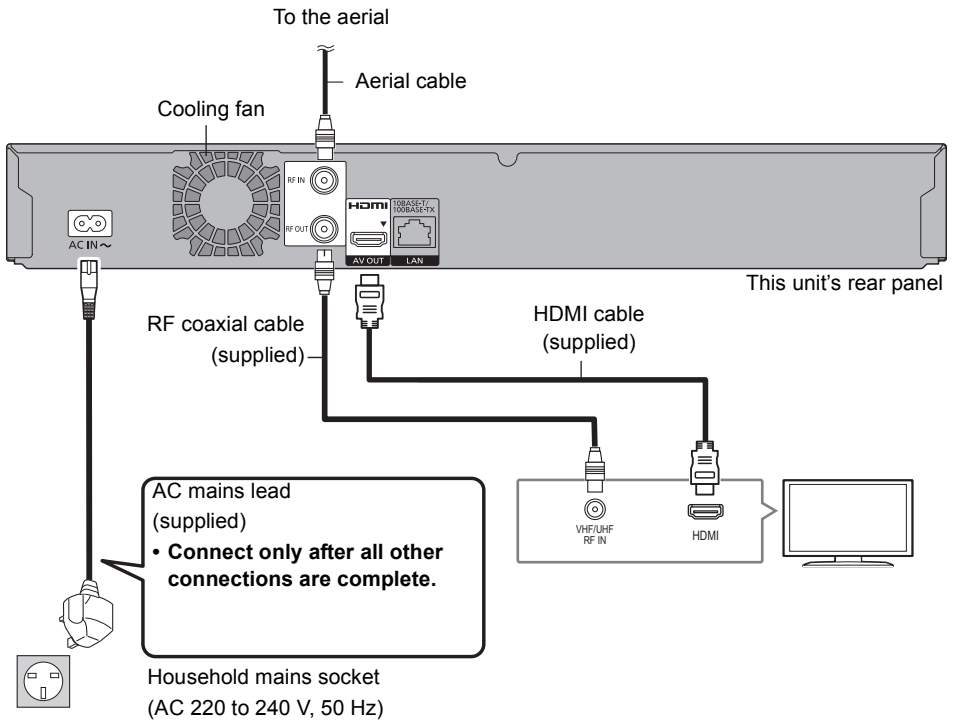

- Keep the RF coaxial cables as far away as possible from other cables.

## Amplifier/receiver connections

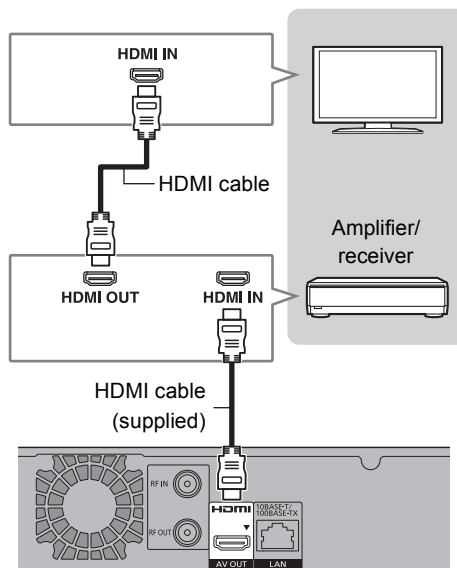

- You will not be able to view 3D programmes images with this connection if your amplifier/receiver is not 3D compatible.

## Network connection

We recommend that you connect this unit to a network. By doing so, you can:

- Keep this unit up to date at all times through software (firmware) updates (⇒ 68, Software (Firmware) Update)

For details about connection method, refer to the instructions supplied with the connected equipment.

After you make the LAN cable connection, the network setting is needed. (⇒ 17, Easy Network Setting)

## LAN cable connection

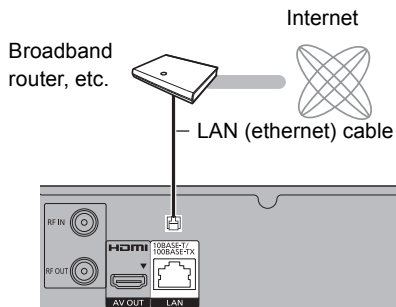

- Use category 5 or above straight LAN cables (STP) when connecting to peripheral devices.

# Settings

## TV operation buttons

The TV can be operated from the TV operation buttons of the remote control.

- Perform the setting if you cannot operate the TV with the TV operation buttons.

**While pressing [TV ⏻], enter the code with the number buttons.**

### Manufacturer and Code No.

Manufacturer	Code	Manufacturer	Code
Panasonic	01/02/03/04	NEC	36
AIWA	35	NOBLEX	33
AKAI	27/30	NOKIA	25/26/27/60/61
BEKO	05/71/72/73/74	NORDMENDE	10
BENQ	58/59	OLEVIA	45
BRANDT	10/15	ONWA	30/39/70
BUSH	05	ORION	05
CENTREX	66	PEONY	49/69
CURTIS	05	PHILCO	41/48/64
DAEWOO	64/65	PHILIPS	05/06/46
DESMET	05	PHONOLA	05
DUAL	05	PIONEER	37/38
ELEMIS	05	PROVIEW	52
FERGUSON	10/34	PYE	05
FINLUX	61	RADIOLA	05
FISHER	21	SABA	10
FUJITSU	53	SALORA	26
FUNAI	63/67	SAMSUNG	32/42/43/65/68
GOLDSTAR	05/50/51	SANSUI	05
GOODMANS	05	SANYO	21/54/55/56
GRADIENTE	36	SCHNEIDER	05/29/30
GRUNDIG	09	SEG	05/69/75/76/77/78
HITACHI	05/22/23/40/41	SELECO	05/25
IRRADIO	30	SHARP	18
ITT	25	SIEMENS	09
JVC	17/30/39/70	SINUDYNE	05
KDS	52	SONY	08
KOLIN	45	TCL	31/33/66/67/69
KONKA	62	TELEFUNKEN	10/11/12/13/14
LG	05/50/51	TEVION	52
MAG	52	THOMSON	10/15/44
METZ	05/28/79	TOSHIBA	16/57
MITSUBISHI	05/19/20/47	WHITE WESTINGHOUSE	05
MIVAR	24	YAMAHA	18/41



- If your TV brand has more than one code listed, select the one that allows correct operation.
- If the brand of your TV is not listed or the code number is invalid for your TV, this remote control is not compatible with your TV.

## Easy Setting

- 1 Turn on the TV, then select the appropriate AV input to suit the connections to this unit.
  - 2 Press [⏻] on the remote control or [⏻/I] on this unit.
    - The Easy Setting will start at the initial power on.
- Auto Setup starts.

(This operation may take some time.)

e.g.,

- 3 Clock will be set automatically. If the clock setting screen appears, set the time manually (⇒ 67, Clock).
  - If the region selection screen appears, select repeatedly until you reach the available region.
- 4 Enter the PIN. This PIN will be used only for the Owner ID-Data Entry screen.

- 1 Press the number buttons to enter 4-digit PIN.
- 2 Repeat step 1 to confirm.
  - Make a note of PIN in case you forget it. The PIN number cannot be reset.
  - Steps 4 – 6 will be skipped in the Easy Setting after “Shipping Condition” (⇒ 67) is performed. (⇒ go to step 7 on page 17)





- 5** Set the Owner ID-Data Entry (“NAME”, “HOUSE NO” and “POSTCODE”).



e.g.,

Owner ID-Data Entry	
PIN	0000
NAME	
HOUSE NO	
POSTCODE	

Change PIN  RETURN

- 1 Select the item, then press [OK].
- 2 Select the character, then press [OK]. Repeat this step.
- 3 Press [BACK/RETURN ].
- 4 Repeat steps 1-3 to enter all data.
- 5 Press [BACK/RETURN ] to exit from the Owner ID-Data Entry screen.

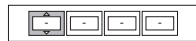
- 6** Enter the new PIN for parental control.

PIN Entry	
Enter a new 4-digit PIN, then press OK. This PIN will be used for controlling viewing and playback. PIN will be set to “0000” by pressing “RETURN” when there is no number input.	
	
 RETURN	Number [0] - [9]

- The default PIN is “0000”.
- 1 Enter the new 4-digit PIN with the number buttons.
    - **Make a note of the PIN you have decided on in case you forget it.**
  - 2 Press [OK].
- 7** Set “Quick Start” to “On”, “Off” or “Timer Setting for Quick Start”, then press [OK]. For details, refer to “Quick Start”. (⇒ 66)

When “Easy Setting has been completed.” appears, Easy Setting is complete.

- Select “Yes” to set network settings.
- Select “No” to finish the Easy Setting.

### To stop partway

Press [BACK/RETURN ].

### To restart setup (⇒ 61, Auto Setup)

### To display the Owner ID information on TV

- 1 While the unit is on, press and hold [OK], the yellow button and the blue button on the remote control at the same time for more than 5 seconds.
  - “00 RET” is displayed on the front panel display.
- 2 Repeatedly press [▶] (right) on the remote control until “01 OID” is displayed on the front panel display.
- 3 Press [OK] on the remote control. The PIN is not displayed.

### To change PIN for parental control

Refer to “PIN Entry”. (⇒ 67)

### To change the region for Channel Sorting

Refer to “Channel Sorting by Region”. (⇒ 61)



- If tuning is cancelled partway through, it may not be possible to receive the channels. Restart setup again.

## Easy Network Setting

After completing “Easy Setting”, you can continue with “Easy Network Setting”.

Follow the on-screen instructions and make the following settings.

When “Easy Network Setting is finished.” appears Press [OK].

# FUNCTION MENU screen

You can easily access the desired functions, such as playback, timer recording, the unit's settings etc. via the FUNCTION MENU.

- 1 Press [FUNCTION MENU].

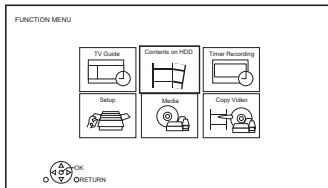

- 2 Select the item, then press [OK].

## FUNCTION MENU list

- **TV Guide (⇒ 20)**
- **Contents on HDD**
  - Recorded Programmes (⇒ 29)
  - Video ( AVCHD ) (⇒ 29)
  - Video ( MP4 / Xvid / MKV ) (⇒ 31)
  - Photo (⇒ 48)
  - Music (⇒ 52)
- **Timer Recording (⇒ 26)**
- **Setup**
  - Basic Settings (⇒ 60)
    - You can change the unit's settings of Tuning, Sound, Display, Connection, Network etc.
  - Wallpaper
    - Personalize a background of the FUNCTION MENU.
    - To select from among "Photo", register photo in advance. (⇒ 49)
- **Media**
  - Disc
  - USB device
  - USB HDD
- **Copy Video**
  - Copy Menu (⇒ 42)
  - Copy Video (AVCHD) to DVD-R (⇒ 47)

# Watching broadcasts

## Press [CH ^ v] to select the channel.

- You can also select the channel by the following operations.
  - Using number buttons
  - Using Channel List (⇒ 20)
  - Using TV Guide system (⇒ 20)
  - Using channel information (⇒ below)

## To switch to the channel you have previously watched

Press [LAST VIEW ○].

- This function will work only for the channels you have watched for more than 10 seconds.

## To switch to the radio channels or to the all channels

Press [RADIO/TV].

### If this unit requests a PIN

If you have locked channels (⇒ 61, Child Lock List), you may be asked to enter the PIN. In that case, enter the 4-digit PIN with the number buttons by following the on-screen instructions.

- PIN can be changed via "PIN Entry". (⇒ 67)

### Using channel information

While watching a programme

Press [STATUS ⊕].

Channel information appears.

e.g.,

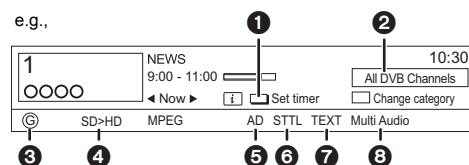

- Set timer (⇒ 27)
- Current Category
- Guidance information for parental control (⇒ 62, Child Lock)
- HD simulcast programmes
- Audio Description
- Subtitle
- Digital teletext
- Multiple audio

## To show detailed information

Press [STATUS ⊕] again.

## To hide the information screen

Press [EXIT ⊗].

## To change Category

Press the blue button.

## To register your favourite channels

- Press [OPTION].
- Select "Digital TV Menu", then press [OK].
- Select "Favourites Edit", then press [OK].
- Refer to "Favourites Edit". (⇒ 60)

## To switch between the current programme and the next programme

Press [◀, ▶].

## To switch to another channel

Press [▲, ▼], then press [OK].

### To show subtitle

When "STTL" appears in channel information (⇒ left)

Press [STTL ⊕].

- Press again to hide subtitle.

### Switching audio

When "Multi Audio" appears in channel information (⇒ left)

- Press [OPTION].
- Select "Multi Audio" in "Digital TV Menu", then press [OK].
- Select the desired audio.
  - Press [EXIT ⊗] to exit from the screen.

## Watching broadcasts

### To listen to the Audio Description

Audio Description adds an additional soundtrack to describe events on screen (narration) and aids understanding and enjoyment, particularly for visually-impaired viewers.

When "AD" appears in channel information (⇒ 19)

- 1 Press [AD].
- 2 Select "Audio Description" and set to "Automatic".
- 3 Select "Volume", then adjust the volume with [◀, ▶].



- Audio Description may not be available depending on the type of audio format.
- When "Dolby Digital / Dolby Digital Plus", "DTS", "MPEG" or "HE-AAC" is set to "Bitstream", the Audio Description may not work. Set them to "PCM" (⇒ 64, Digital Audio Output).
- You can also set "Audio Description" active in the Setup menu. (⇒ 62)

### To show Digital teletext (MHEG)

When "TEXT" appears in channel information (⇒ 19)

- 1 Press [TEXT ].
- 2 Use [▲, ▼, ◀, ▶], number buttons or colour buttons, etc. according to on-screen instructions.



- Some functions of Digital teletext are deactivated during recording.
- "Player PIN Control" applies access control for some MHEG services. If you have locked viewing of Digital teletext (MHEG) (⇒ 61, Player PIN Control), PIN is required to start viewing.

### Aspect

You can switch the aspect ratio of the screen. (⇒ 71)

## Using Channel List

You can select from the list of channel names.

- 1 Press [OK].

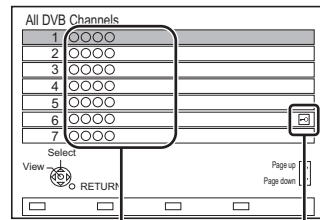

Channel names

Encrypted channel

- 2 Select the channel, then press [OK].

### To edit the channel list

Refer to "Channel List". (⇒ 61)



- Encrypted channels cannot be watched.

## Using TV Guide system

- 1 Press [GUIDE].  
e.g. Landscape view

Landscape		TUE 06/01/2015 8:05		Category: All DVB Channels	
8:00 - 9:45	SKM workman	9:00	9:30	10:00	10:30
1 0000	SKM workman			Penguin	Will
2 0000	Kitten			House dog	
3 0000	Vacation			Hunting	
4 0000	Pommes grass			News	Top run
5 0000	News			Com Shopping	Area 91
6 0000	Venus			Moon	
7 0000	Construction			Mr. Otter	Hippopotamus
8 0000	Great river			Mr. Otter	Dodge

- 2 Select the programme, then press [OK].
- 3 Select "View", then press [OK].

### To change TV Guide view

Press [GUIDE] to switch between "Landscape" view and "Portrait" view.

### Page up/down

Press [CH ^ v].

**To view a programme list for another day**

Press the green button (Previous) or the yellow button (Next).

**To see programme information**

Press [STATUS ⓘ].

**To retrieve the programme data for the area where data have not been acquired**

Select the area, then press [STATUS ⓘ].

**To set a timer Recording using the TV Guide System (⇒ 24)****To search the programmes**

Refer to "To search the programmes". (⇒ 25)



- Selection of channel is made easy by creating a Favourite of the channels you watch often. (⇒ 60, Favourites Edit)

**REWIND LIVE TV/PAUSE LIVE TV**

This unit temporarily saves a live TV programme you are watching with this unit's tuner on HDD.

**REWIND LIVE TV**

You can rewind live TV programme to the point where temporary save has started (up to 1.5 hours).

**PAUSE LIVE TV**

You can pause live TV programme and restart watching from the paused position.

- 1 While watching TV  
**REWIND LIVE TV:**  
 Press [SLOW/SEARCH ◀◀] to rewind.  
**PAUSE LIVE TV:**  
 Press [PAUSE ||] to pause.
  - The maximum amount of the temporary save is 1.5 hours.
- 2 When you want to resume:  
 Press [PLAY/× 1.3 ▶].
  - You can perform search or Quick View, etc.
  - If temporary save stops (⇒ right), playback will be performed by that point.

**Display information**

While pausing or rewinding a broadcast:  
 Press [STATUS ⓘ].

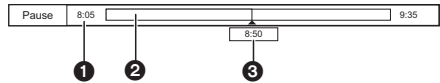

- Press [STATUS ⓘ] again.

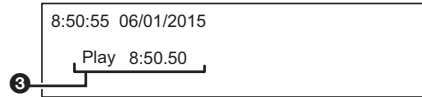

- 1 The time that you can rewind the live programme.
- 2 The amount of time temporarily saved on HDD.
- 3 The time of the current playback position.

**To stop REWIND LIVE TV or PAUSE LIVE TV**

- 1 Press [STOP ■].
- 2 Select "Yes", then press [OK].

**To hide the display information**

Press [EXIT ⊗].



- Temporary save stops in the following cases:
  - When switching to other channels or other screen
  - When two programmes simultaneous recording is started
  - When performing PAUSE LIVE TV or REWIND LIVE TV for more than 8 hours (This may vary depending on the HDD free space.)
- These functions do not work in the following cases:
  - When the clock is not set
  - When two programmes simultaneous recording is started
  - While copying
  - While watching a programme being recorded
  - When a radio programme is selected

# Recording TV programmes



- This unit can record two programmes being broadcasted at the same time.

- 1 Select the channel to record.**
- 2 Press [REC MODE] and select the conversion mode, then press [OK].**
  - This unit will record the programmes in DR mode once, and then automatically convert to the selected recording mode while this unit is in standby.
  - Recording mode (⇒ 9)

Conversion Mode Setting		HDD Remain	0h	0m (DR)	Data Size
					Off (DR)
High Definition	HG				Large ↑ ↓ Small
	HX				
	HE				
	HL				
	HM				
Standard Definition	XP				Large ↑ ↓ Small
	SP				
	LP				
	EP				

- The conversion mode set here is used as an initial value for the next recording.

- 3 Press [REC ●].**  
Recording will start.
- 4 Select "Automatic Stop", then press [OK].**
  - **One touch recording (OTR)**  
Recording stops automatically when the programme ends.

REC1/OTR	
○○○○	8:00 - 8:45
Vacation	
Automatic Stop (Guide Link) at 8:45	
Recording Time	30 min
Continuous recording	

## To set the recording time

- 1 Select "Recording Time" or "Continuous recording" in step 4 (⇒ left).

### Recording Time:

You can set the length of recording time from 30 minutes to 4 hours.

- You can select the recording time with [◀, ▶].

- 2 Press [OK].

## To convert the recording mode after recording in DR mode

Refer to "File Conversion". (⇒ 38)

## To confirm whether the conversion is completed

Refer to "To confirm whether the conversion is completed". (⇒ 38)

## To cancel a conversion

Refer to "To cancel a "During standby" conversion". (⇒ 38)



- If a timer recording reaches its start time when all tuners are being used for recording, the recording (OTR) of one of the programmes terminates.
- Digital teletext will not be recorded.
- Following contents or media cannot be played back while recording.
  - video file
  - photo
  - USB HDD (For data files, ⇒ 9) and USB memory
- Copying cannot be performed while recording.
- When "Automatic Standby after OTR" is set to "On" (⇒ 66), this unit is turned to standby mode if this unit is not operated for approximately 5 minutes after completing "Automatic Stop" or "Recording Time".

## Operation during Recording

### To check the recording programme

Press [STATUS ].

e.g., While recording two programmes simultaneously

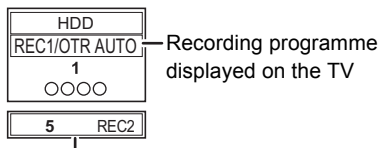

Recording programme not displayed on the TV

### To stop recording

Press [STOP ].

**When recording one programme:**

If the following screen appears

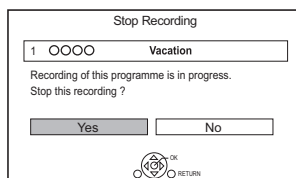

Select "Yes", then press [OK].

**When recording two programmes:**

Following screen appears

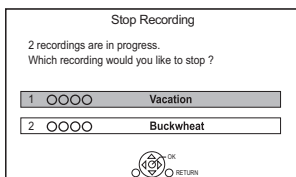

1 Select the programme, then press [OK].

2 Select "Yes", then press [OK].

### To pause recording

After displaying the recording programme, press [PAUSE ].

- Press again to restart recording.  
(A title is not split into separate titles.)



- Timer recording programme cannot be paused.

### To record two programmes simultaneously

While recording, perform steps 1–4 on page 22.



- Channel can only be switched between the recording programmes.

### Simultaneous rec and play

You can play the recording title from the beginning or the titles previously recorded to the HDD.

1 Press [VIDEO MENU].

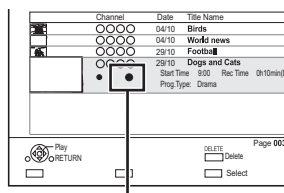

"●" (red) is displayed on the recording programme.

2 Select the title, then press [OK].

### Notes for Conversion

- The title before conversion (the title recorded in DR mode) will be deleted once the conversion is completed.
- Conversion will take about the same time as the recorded duration.
- When the HDD does not have enough remaining space, conversion will not start.
- Conversion is stopped when this unit is turned on. Conversion will start from the beginning again once the unit is switched to standby mode.
- When converted, audio content and subtitle will be converted with the same settings as at the start of recording.

# Timer recording



- You can enter up to 32 programmes within a month in advance. (Each daily or weekly programme is counted as one programme.)
- This unit can record two programmes being broadcasted at the same time.

## Preparation

If you want to change the recording mode: Press [REC MODE] and select the recording mode, then press [OK].

### 1 Press [GUIDE].

TV Guide screen appears.

### 2 Select the programme, then press the red button.

The timer icon “⊖” (red) is displayed.

- If on-screen instructions are displayed, follow them.



- This unit has several functions that enable timer recordings to be controlled by the signal sent from the broadcaster. (⇒ 25) If the signal is not sent correctly, the recording may lack the beginning or the ending part of the programmes.
- Some broadcasters may not send programme information. When programme information is not displayed correctly, use manual timer recording. (⇒ 26)
- If the unit cannot record the selected programme, the unit will record the repeat programme if it is available. However, this unit will not record the repeat programme, if any part of the selected programme is recorded.

## To use TV Guide system (⇒ 20)

## Operation during Recording (⇒ 23)

### To edit the timer recording on the TV Guide screen

- 1 Select the programme to edit, then press the red button.
- 2 Select “Timer Rec Edit”, then press [OK].
- 3 Go to step 3 on page 26, “Manually programming timer recording”.
  - Some options cannot be changed when “Guide Link” is effective. (⇒ 25, 27)

### To cancel a timer recording on the TV Guide screen

- 1 Select the programme to cancel, then press the red button.
- 2 Select “Timer Rec Cancel”, then press [OK]. (“⊖” disappears)

### If the screen for selecting single or series timer recording appears

Select “Single Timer Rec.” or “Series Timer Rec.” (⇒ 25), then press [OK].

### If “Programme Selection” screen appears

Depending on the signal sent from the broadcaster, both High Definition picture programme and Standard Definition picture programme exist.

Select the programme, then press [OK].

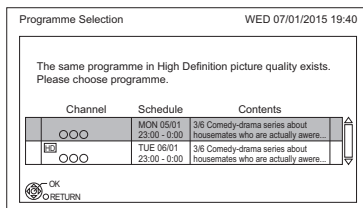



## To search the programmes

- 1 On the TV Guide screen:  
Press the blue button.
- 2 Select the item, then press [OK].

### Keyword Search

Displays programmes including the input keyword.

- Refer to "Entering text". (⇒ 71)

### Prog.Type Search

Displays programmes of the selected type.

- Select the programme type, then press [OK].

### Category Selection

Displays programmes in the selected category.

- To return to the previous TV Guide list  
Select "All DVB Channels".

- 3 Select the programme, then press the red button for timer recording.

## If "Overlapped Timer Recording" screen appears

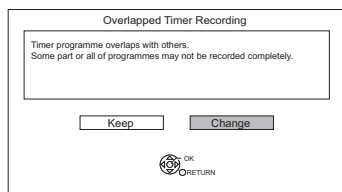

You can eliminate the overlapping or may change with repeat event for the duplicated programme.

- 1 Select "Change", then press [OK].
- 2 Follow the on-screen instructions.

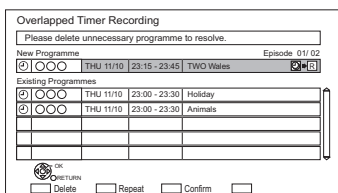

- Red: Delete  
Green: Record repeat programme  
Yellow: Exit (Overlapping is not resolved)

## Various functions with Freeview

### Guide Link

The recording's start and stop times can be controlled by the broadcaster, e.g. delayed start.

- This is indicated by "Guide Link" in the Timer Recording screen (⇒ 27).
- The "Guide Link" function may not work if you manually change the start time or the stop time over 10 minutes.

### Series Timer Recording

You can record all the episodes of a series by setting just one timer recording.

- To check the schedule of the series

On the Selection Screen (⇒ 26, Recording recommended programme, step 1):  
Press the blue button.

Channel		Schedule	Contents
①	000	TUE 08/01 23:00 - 0:00	26 Comedy-drama series about housemates who are actually awere...
②	000	WED 07/01 23:00 - 0:00	36 Comedy-drama series about housemates who are actually awere...
③	000	THU 08/01 23:00 - 0:00	36 Comedy-drama series about housemates who are actually awere...

⊙ Programme for which you set the timer recording

🕒 Series Timer Recording programme

**R** Repeat programme

**HD** High definition programme



- Titles recorded using "Series Timer Rec." are bundled and displayed as a "group" in the Video Menu screen (⇒ 29).
- The series recording will be cancelled if there has been no episode of the series for 13 weeks.

## Timer recording

### Recording recommended programme

You can record a programme that the broadcaster recommends.

- On the TV Guide screen:  
Select the programme, then press [OK].

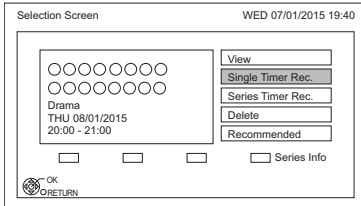

- Select "Recommended", then press [OK].

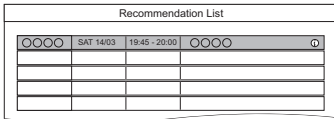

- Select the programme, then press [OK].
  - If the screen for selecting single or series timer recording, or "Programme Selection" screen appears, refer to page 24.
- Press [OK].  
The timer icon (red) is displayed on the Recommendation List.
  - To exit from the screen  
Press [EXIT ⊗].

### To cancel the timer recording on the Recommendation List

- Select the programme with the timer icon (red), then press [OK].
- Select "Yes", then press [OK].  
(The timer icon disappears.)



- "Recommended" cannot be selected if there is no recommended programme.

### Manually programming timer recording

- Press [PROG/CHECK].

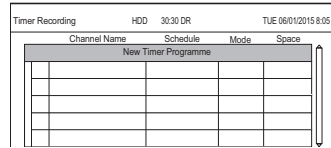

- Select "New Timer Programme", then press [OK].
- Select the items and change the items.  
(⇒ 27, Timer recording options)
- Press [OK].  
The timer programme is stored.

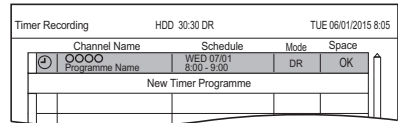

### To confirm and edit the timer programme

Refer to "To confirm and edit a timer programme".  
(⇒ 28)

### Operation during Recording

Refer to "Operation during Recording". (⇒ 23)

## Timer recording options

Select the items and change the settings.

e.g.,

Channel	Day/Date	Start	Stop	Mode	Conv.	Subtitles
1	WED 07/01	8:00	9:00	DR	OFF	OFF

Title Name: Vacation

Category:  Category  Date or Weekly?

### Channel

- You can select Category with the red button.

### Day/Date

- You can select "Date" or "Weekly" by pressing the green button.

### Auto Renewal Recording

- (Only daily/weekly/series timer recording)  
The unit will record the new programme over the old one.

Press the yellow button.

"Renew : ON" is displayed.

### Start/Stop

- Press and hold [▲, ▼] to alter in 15-minute increments.

### Mode/Conv.

Refer to step 2. (⇒ 22)

### Subtitles

You can choose whether or not to record the subtitle at conversion.

(Only when item other than "OFF" is selected in "Conv.")

### Title Name

- Select "Title Name", then press [OK].
- Refer to "Entering text". (⇒ 71)

## Timer recording from channel information

You can make timer recording of the current or next programme.

- While watching a programme  
Press [STATUS Ⓞ].

e.g.,

1	NEWS	10:30
0000	9:00 - 11:00	All DVB Channels
	Now	Set timer
		Change category
	MPEG	STTL TEXT

- Display the channel information of a programme to record.
  - Switch the programme with [◀, ▶].
  - Switch the channel with [▲, ▼].
- Press the yellow button.
- Go to step 3 on page 26, "Manually programming timer recording".
  - Some options cannot be changed when "Guide Link" is effective. (⇒ 25, Guide Link)

## Notes on timer recording

- When the programme recorded in DR mode is converted, the audio content and subtitle language will be selected according to the following settings:
  - "Multi Audio" of "Preferred Multi Audio" (⇒ 62)
  - "Subtitles" of "Preferred Subtitles" (⇒ 62)
- When you programme successive timer recordings to start, about last 1 minute of earlier programme will not be recorded.
- Timer recording will not start while:
  - copying a title in high speed mode [with finalising or creating Top Menu (+RW)]
  - copying a title in normal speed mode
  - converting a title in "File Conversion" (Only when "Now" is selected)
  - copying HD Video (AVCHD) from USB device
  - copying video/photos/music files
  - formatting
  - finalising/creating Top Menu

## Timer recording

### To confirm and edit a timer programme

#### 1 Press [PROG/CHECK].

e.g.,

Channel Name	Schedule	Mode	Spaces
World news	MON 13:01 11:00 - 11:45	DR	OK
Football	MON 13:01 10:00 - 11:50	→HG	OK
Star	MON 13:01 11:38 - 1:00	DR	☒ I
Dogs and Cats	TUE 07:01 8:00 - 10:45	DR	☒
New Timer Programme			
Total 3/32 <input type="checkbox"/> Turn Off <input type="checkbox"/> Delete <input type="checkbox"/> Resolve overlap <input type="checkbox"/> Info <input type="checkbox"/> Page Up <input type="checkbox"/> Page Down			

#### 2 Select the programme, then perform the operations.

##### To deactivate a timer programme

Press the red button.

- The timer icon “☉” will change from red to grey.
- Press the red button again to activate timer recording standby. (The timer icon “☉” will change to red.)

##### To delete a timer programme

Press [DELETE].

##### To resolve an overlap timer programme

Press the green button.

- The overlapped timer recording list will appear. (⇒ 25)

##### To edit a timer programme

- 1 Press [OK].
- 2 Change the timer recording options.
  - Refer to “Timer recording options”. (⇒ 27)
- 3 Press [OK].

##### To show programme information

Press [STATUS ⓘ].

##### To exit the timer recording list

Press [EXIT ⊗].



- “No Data” is displayed on a series recording item if there will be no episode of the series for the next 8 days. We recommend you delete the “No Data” item after you confirm the last episode of the series is recorded.

### Screen icons

- ☉ Red: Timer recording standby is activated.
- ☉ Grey: Timer recording standby is deactivated.

- (Red) Currently recording programme

- ☉ A part or all of the programme will not be recorded since the programme is overlapping.

- ⊞ The HDD is full.

- ⊞ Copy-protected programme  
It was not recorded.

- ⊞ The recording of the programme was not completed because of some reason.

- ⌚ Auto Renewal Recording is set (⇒ 27).

- Ⓜ Guide Link (⇒ 25)

- Ⓜ Split Programme

- ⌚ Series Timer Recording (⇒ 25)

- OK Displayed if the recording can fit in the remaining space

- > Daily or weekly timer programme is set.

- (Date) • The timer remains active until the date indicated below -->.

- ! It may not be possible to record because:
  - there is not enough space left.
  - the number of possible titles has reached its maximum. (⇒ 8)
  - programmes are deactivated, etc.

# Playing titles on the HDD



\* "For recorded titles (⇒ 9)" only

- 1** Press [FUNCTION MENU].
- 2** Select "Contents on HDD", then press [OK].

e.g.,



- 3** To play recorded titles:  
Select "Recorded Programmes", then press [OK].  
The Video Menu screen appears (⇒ right).

To play HD Video (AVCHD):  
Select "Video ( AVCHD )", then press [OK].

The AVCHD tab appears on the Video Menu screen (⇒ right).

To play video files:  
Select "Video ( MP4 / Xvid / MKV )", then press [OK].

The video list screen appears (⇒ 32).

- 4** Select the title, then press [OK].

## Video Menu screen

e.g.,

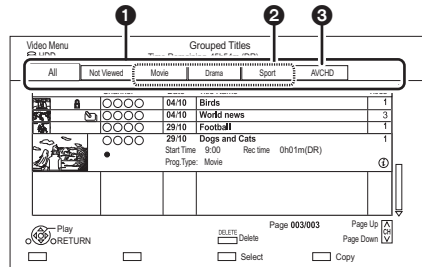

- 1** Tab (⇒ 30)
- 2** Programme type
- 3** AVCHD tab





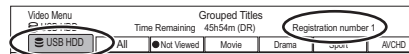











- **USB HDD** When connecting registered USB HDD, "USB HDD" tab and registration number appears.  
Select "USB HDD" tab.

e.g.,



## Playing titles on the HDD

### Screen icons

	Currently recording programme
(Red)	
	Protected title
	Title was not recorded due to recording protection
	Title cannot be played (When data is damaged etc.)
	Grouped titles
	Title has not yet been played
(Blue)	
	Title is recorded using a different encoding system from that of the unit.
	Change the "TV System" (⇒ 65).
	Radio programme
	3D contents
	Recorded in 1080/50p contents
	Recorded in 1080/60p contents
	This icon is displayed with the following titles when "Child Lock" is set to "On". (⇒ 62)
	- Title with Guidance information - Title restricted by Child Lock List (⇒ 61) • PIN is required to play.
	Title has been recorded in Series timer recording.
	Title has been recorded in Series timer recording and has not yet been played.
	Recording did not complete as the timer recording has started.

### Tab

You can quickly find the recorded titles by selecting the tab.

#### To select the tab

Press [◀, ▶].

#### To change the displayed programme type tab

- 1 Select the programme type, then press the green button.
- 2 Select the item, then press [OK].

### Showing Information

Select the title, then press [STATUS ⓘ].

### Showing grouped titles

- 1 Press [OPTION].
- 2 Select "Grouped Titles" or "All Titles", then press [OK].

#### Grouped Titles:

- Two or more titles recorded in the daily/weekly/series timer recording mode are bundled and displayed as one item.

#### All Titles

### Playing back grouped titles

- 1 On the Grouped Titles screen:  
Select the item marked with .
- 2 **When playing all titles:**  
Press [PLAY/× 1.3 ▶].

#### When playing the individual title:

Press [OK] and select the title, then press [OK].

### Editing the grouped titles

- 1 Select the title or the group, then press the yellow button.
  - A check mark is displayed. Repeat this step.
    - Press the yellow button again to cancel.
- 2 Press [OPTION].
- 3 Select the item, then press [OK].

#### Create Group:

Selected titles are bundled to form a group.

#### Release Grouping:

All the titles in the group are released.

#### Remove:

Selected titles are removed from the group.

### Playback from Chapter View

- 1 Select the title, then press [OPTION].
- 2 Select "Chapter View", then press [OK].

e.g., **HDD**

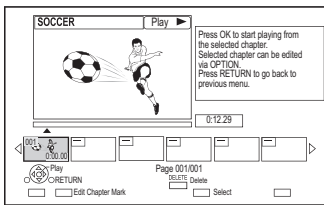

- 3 Select the chapter, then press [OK].

### To edit the chapter in Chapter View

Refer to "Editing chapters". (⇒ 39)

### Video list screen

e.g.,

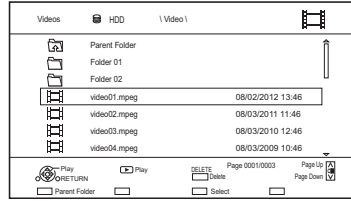

### Screen icons

 Folder

 Titles

 Move to the parent folder

# Playing titles on the media



\* "For data files (⇒ 9)" only

- 1 Insert the media.**
  - AVCHD: If the menu screen is not displayed Press [PLAY/× 1.3 ▶].
- 2** When the Video Menu screen or menu screen etc., appears:
  - **Select the item or title, then press [OK].**
  - Repeat this step if necessary.

## To play back the playlist created on other equipment

- 1 Press [FUNCTION MENU].
- 2 Select "Disc" in "Media", then press [OK].
- 3 Select "Playlists", then press [OK].
- 4 Select the playlist, then press [OK].

## Menu screen

Selecting screen for each operation is displayed when the media is inserted, and you can access the operation screen easily.

e.g., **USB**

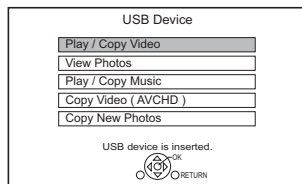

- Display items differ depending on what is recorded in each media.

**If the menu screen is not displayed, display it by performing the following operation.**

- 1 While stopped Press [FUNCTION MENU].
- 2 Select "Media", then press [OK].
- 3 Select the media, then press [OK].

## Video list screen

e.g.,

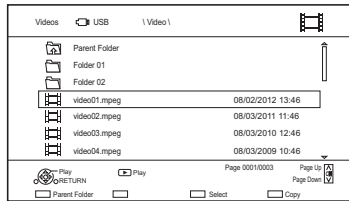

## About screen icons (⇒ 31)

## Video Menu screen

e.g.,

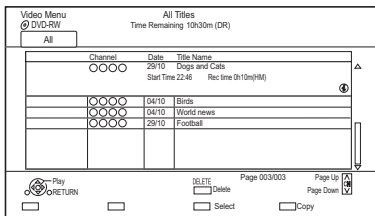

## Showing Information

Select the title, then press [STATUS ⓘ].

## Playback from Chapter View (⇒ 31)



# Operation during play



- Discs continue to rotate while menus are displayed. Press [STOP ■] when you have finished playback to protect the unit's motor, your TV screen, etc.

## General operations

### Status messages

Press [STATUS ⓘ] twice.

e.g.,

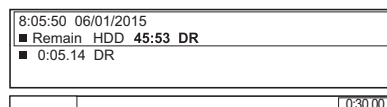

### Stop

Press [STOP ■].

### Resume play function

Press [PLAY/× 1.3 ▶] to restart from the stopped position.



- Discs:** Only previous stopped position is memorised. The position may be cleared if the tray is opened or the unit is switched to standby mode.

### Quick View

Press and hold [PLAY/× 1.3 ▶].

- Press again to return to normal speed.



- Xvid, MKV, MP4 and MPEG2:** Quick View is not effective.
- Quick View is not effective when playing back the DVD-RW disc.
- Quick View may not work when recording in XP or FR mode.

### Search

Press [SLOW/SEARCH ◀◀] or [SLOW/SEARCH ▶▶].

- Press [PLAY/× 1.3 ▶] to restart play.



- The speed increases up to 5 steps.  
(+R +RW): Up to 3 steps)
- Xvid, MKV, MP4 and MPEG2:** Audio is not heard during all levels search.

### Pause

Press [PAUSE ||].

- Press [PLAY/× 1.3 ▶] to restart play.

### Slow-motion

While paused, press [SLOW/SEARCH ◀◀] or [SLOW/SEARCH ▶▶].

- Press [PLAY/× 1.3 ▶] to restart play.



- The speed increases up to 5 steps.
- Xvid, MKV, MP4 and MPEG2:** Slow-motion is not effective.
- AVCHD (DVD-R):** Forward direction [SLOW/SEARCH ▶▶] only.

### Frame-by-frame

While paused, press [◀] (◀||) or [▶] (||▶).

- Each press shows the next frame.
- Press and hold to change in succession forward or backward.
- Press [PLAY/× 1.3 ▶] to restart play.



- Xvid, MKV, MP4 and MPEG2:** Frame-by-frame is not effective.
- AVCHD (DVD-R):** Forward direction [▶] (||▶) only.

### Manual Skip

**Skip forward 1 minute:**

Press [MANUAL SKIP +60s].

**Skip backward 10 seconds:**

Press [MANUAL SKIP -10s].



- Xvid and MKV:** Manual Skip is not effective.

## Operation during play

### Skipping the specified time

- 1 Press [TIME SLIP].
- 2 Select the time with [▲, ▼].
  - Press and hold [▲, ▼] to change the time by 10-minute.
- 3 Press [OK].
  - Play skips the specified time.



- **DVD-V**, **Xvid**, **MKV**, **AVCHD**, **MP4** and **MPEG2**: [TIME SLIP] is not effective.

### To display menu

#### DVD-V

- 1 Press [OPTION].
- 2 Select "Playback Menu", then press [OK].
- 3 Select "Top Menu" or "Menu", then press [OK].

### Skipping the title or chapter

Press [SKIP ◀◀] or [SKIP ▶▶].



- **HDD** **USB HDD** (For recorded titles, ⇨ 9): It will not skip the title. But the title in the grouped titles will be skipped. (⇨ 30)

### To create Chapter Marks

#### HDD USB HDD (For recorded titles, ⇨ 9) RAM

During the playback or pause  
Press [CHAPTER].

### To delete the Chapter Mark

#### HDD USB HDD (For recorded titles, ⇨ 9) RAM

- 1 While paused  
Press [SKIP ◀◀] or [SKIP ▶▶] and skip to the location you want to delete.
- 2 Press [CHAPTER].
- 3 Select "Yes", then press [OK].

### Changing audio

Select the desired audio with "Multi Audio" in the Basic Operation menu (⇨ 58).

### Switching subtitles

#### HDD USB HDD (For recorded titles, ⇨ 9)

- 1 Press [STTL ].
  - 2 Press [OK].
  - 3 Select "On" or "Off", then press [OK].
- If you want to switch the subtitle language, select it in the Basic Operation menu (⇨ 58).

#### DVD-V, Xvid and MKV:

Display with "Subtitle Settings" in the Basic Operation menu (⇨ 58).

### Listening to the Audio Description

#### HDD USB HDD (For recorded titles, ⇨ 9)

- 1 Press [AD].
- 2 Select "Audio Description" and set to "Automatic".
- 3 Select "Volume", then adjust the volume with [◀, ▶].



- When "Dolby Digital / Dolby Digital Plus", "DTS", "MPEG" or "HE-AAC" is set to "Bitstream", the Audio Description may not work. Set them to "PCM" (⇨ 64, Digital Audio Output).
- You can also set "Audio Description" active in the Setup menu. (⇨ 62)

### Aspect

You can switch the aspect ratio of the screen.  
(⇨ 71)

## 3D video playback

### Preparation

Connect 3D compatible TV to this unit. (⇒ 14)

- Perform the necessary preparations for the TV.

### Play back following the instructions displayed on the screen.

### Preparatory 3D settings

#### 3D Type

If 3D video cannot be played back in 3D, you may be able to play it in 3D by changing the setting. (⇒ 64)

#### 3D AVCHD Output

If 2D AVCHD video is recognised as 3D video and cannot be played back correctly, you may be able to play it by changing the setting. (⇒ 64)

#### 3D Playback Message

Hide the 3D viewing warning screen. (⇒ 64)

### 3D settings during playback

Change this setting when the screen is not correctly displayed for 3D compatible programmes.

- 1 Press [OPTION].
- 2 Select "Playback Settings" in "Playback Menu", then press [OK].
- 3 Select "3D Settings", then press [OK].
- 4 Select the item, then press [OK].

#### Signal Format

- Original:

Keep original picture format.

- Side by side:

3D picture format comprising of left and right screens.

#### Graphic Display Level

Adjust the 3D position for the playback menu or message screen etc.



- Please refrain from viewing 3D images if you do not feel well or are experiencing visual fatigue. In the event that you experience dizziness, nausea, or other discomfort while viewing 3D images, discontinue use and rest your eyes.
- This unit only guarantees the playback of the Frame Sequential and the Side-by-Side (Half) programme types.
- Depending on the connected TV, the video being played back might switch to 2D video due to changes in resolution etc. Check the 3D setting on the TV.
- It may display as Side-by-Side (2 screen structure) when playback of the 3D video is started. Select "Side by side" in "Signal Format". (⇒ left)
- 3D video cannot be played back while recording.

# Deleting/Editing titles

Once deleted, divided or partially deleted, content cannot be restored to its original state. Make certain before proceeding.



\* "For recorded titles (⇒ 9)" only



- If the disc is protected, release the protection. (⇒ 69, Disc Protection)
- PIN is required to edit the titles with **G** in some functions. (⇒ 30)

## Deleting recorded titles

- 1 On the Video Menu screen:  
Select the title.

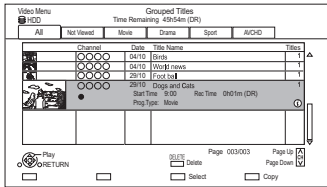

- 2 Press [DELETE].
- 3 Select "Delete", then press [OK].

### Multiple selection

Select the title, then press the yellow button. A check mark  is displayed. Repeat this step.

- Press the yellow button again to cancel.

### Deleting during play

- 1 Press [DELETE] while playing.
- 2 Select "Delete", then press [OK].



- Available disc space after deleting:
  - **HDD** **USB HDD** **RAM**  
The space deleted becomes available for recording.
  - **DVD-R** **+R**  
Available space does not increase even after the contents are deleted.
  - **DVD-RW** **+RW**  
Available recording space increases only when the last recorded title is deleted.
- Even after deletion is completed, it may take time until the updated available space is displayed.

## Editing recorded titles

- 1 On the Video Menu screen: Select the title.
  - Multiple selection (⇒ left)
- 2 Press [OPTION].
- 3 Select the item, then press [OK].  
e.g.,

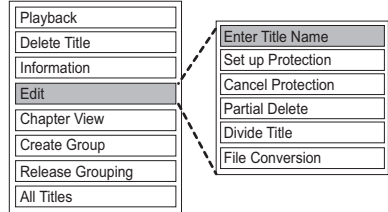

## Entering title name

- 1 Select "Enter Title Name" in "Edit", then press [OK].
- 2 Refer to "Entering text". (⇒ 71)

## Setting protection

**HDD** **USB HDD** **RAM** **+R** **+RW**

Protection setting prevents the title from accidental deletion.

- 1 Select "Set up Protection" or "Cancel Protection" in "Edit", then press [OK].
- 2 Select "Yes", then press [OK].
  -  appears when setting the protection.

## Partial deleting

**HDD** **USB HDD** **RAM**

- 1 Select "Partial Delete" in "Edit", then press [OK].
- 2 Press [OK] at the start point and end point to delete.
  - You can find the desired point by using play, search, etc. (⇒ 33)
- 3 Select "Continue", then press [OK].
  - Select "Next", then press [OK] to delete other sections. Up to 20 sections can be set. (⇒ go to step 2)
- 4 Select "Delete", then press [OK].
- 5 Press [BACK/RETURN ⊕].



- Chapter Mark is generated in the scene that was partially deleted.

## Dividing title

**HDD** **USB HDD** **RAM**

- 1 Select "Divide Title" in "Edit", then press [OK].
- 2 Press [OK] at the point to divide the title.
  - You can find the desired point by using play, search, etc. (⇒ 33)
- 3 Select "Continue", then press [OK].
- 4 Select "Divide", then press [OK].

### To confirm the division point

After performing step 2.

Select "Preview", then press [OK].

- The unit plays 10 seconds before and after the division point.

### To change the division point

After performing step 2.

Restart play and select "Divide", then press [OK] at the division point.



- **HDD** **USB HDD** Divided titles will become a group of titles.

## Deleting/Editing titles

### File Conversion

**HDD** **USB HDD**

File Conversion is a function to convert the recording mode of the title in DR mode and AVCHD contents. The size of the converted title will be small regularly. It will take about the same time as the recorded duration.

- 1 Select "File Conversion" in "Edit", then press [OK].

e.g.,

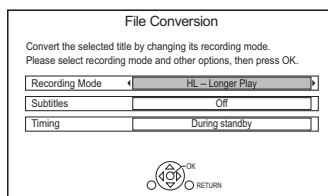

- 2 Set the conversion options, then press [OK].

#### Recording Mode (⇒ 9):

- **USB HDD** You cannot select XP, SP, LP and EP mode.

#### Subtitles:

##### • Automatic

Subtitles will be recorded if they are included in the title.

##### • Off

Subtitle will not be recorded.

#### Timing:

##### • Now

Conversion begins immediately after step 4.

- Timer recording will not be performed during conversion.

##### • During standby

Conversion will be performed after the unit is switched to standby mode.

- 3 Select the item, then press [OK].

#### Convert & Delete:

The original title will be deleted to save HDD capacity after conversion.

#### Convert Only:

The original title remains after conversion.

- 4 "Now" conversion:

Select "Start", then press [OK].

#### "During standby" conversion:

Press [OK].

- Conversion will be performed after the unit is switched to standby mode.

"COPY" or "CONV" on the front panel display remains lighted during conversion.

#### To cancel a "Now" conversion

Press and hold [BACK/RETURN ⊕] for more than 3 seconds.

#### To confirm whether the conversion is completed

Press [VIDEO MENU].

e.g.,

Channel	Date	Title Name	Titles
○○○○	04/10	Birds	1
○○○○	04/10	World news	1
○○○○	29/10	Football	1
○○○○	29/10	Dogs and Cats	1
●	Start Time: 9:00	Rec time: 1h00m(DR→HL)	1
	Prog.Type: Movie		

When "○○ → ○○ (Recording mode for conversion)" is displayed, the conversion has not finished.

#### To cancel a "During standby" conversion

After performing steps 1–2 (⇒ 36, Editing recorded titles)

- 1 Select "File Conversion" in "Edit", then press [OK].
- 2 Select "Yes", then press [OK].



- To use "File Conversion", the HDD needs enough storage capacity.
- File Conversion is stopped when this unit is turned on during performing "During standby" conversion. Conversion will start from the beginning again once the unit is switched to standby mode.
- When converted, the audio content and subtitle language will be selected according to the following settings:
  - "Multi Audio" of "Preferred Multi Audio" (⇒ 62)
  - "Subtitles" of "Preferred Subtitles" (⇒ 62)
- When converted, 3D information may not be retained.
- About limitations on "Audio Description". (⇒ 9)

## Editing chapters

**HDD** **USB HDD** **RAM**

- 1 Select "Chapter View", then press [OK].
- 2 Perform the editing operations.

### Edit Chapter Mark:

Select the point where you want to start a new chapter while viewing the title.

- 1 Press the green button.
- 2 Press [OK] at the point you want to divide.
  - Repeat this step.
- 3 Press [BACK/RETURN] to go to Chapter View screen.

### To delete the chapter:

- 1 Select the chapter, then press [DELETE].
  - Multiple selection (⇒ 36)
- 2 Select "Delete", then press [OK].

### To combine chapters (Delete chapter mark):

- 1 Select the chapter, then press [OPTION].
- 2 Select "Combine Chapters", then press [OK].
- 3 Select "Combine", then press [OK].  
The selected chapter is combined to the next chapter.

## Playback from Chapter View

Refer to "Playback from Chapter View". (⇒ 31)



- The maximum number of chapters:  
(Depends on the state of recording.)  
**HDD** **USB HDD**: Approx. 1000 per title  
**RAM**: Approx. 1000 per disc
- **HDD** **USB HDD**: When the title has the maximum number of chapters, you cannot perform the Resume play function (⇒ 33) with the title.

## Deleting video files on the HDD

**HDD**

- 1 On the video list screen:  
Select the file or folder.

e.g.,

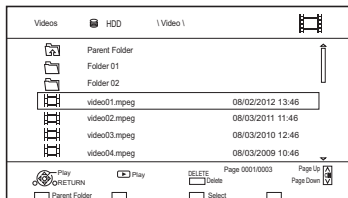

- Multiple selection (⇒ 36)

- 2 Press [DELETE].
- 3 Select "Yes", then press [OK].



- All files in the folder will be deleted.

# Copying titles



※1 “For recorded titles (⇒ 9)” only

※2 The title in the source media will be deleted.

※3 The recording mode cannot be changed.

## 1 Insert or connect the media.

## 2 Press [FUNCTION MENU].

## 3 Select “Recorded Programmes” or “Video ( AVCHD )” in “Contents on HDD”, then press [OK].

## 4 Select the title.

### • Multiple selection

Select the title, then press the yellow button.

A check mark  is displayed. Repeat this step.

- Press the yellow button again to cancel.

## 5 Press the blue button.

### If the copy direction selection screen is displayed:

Select the copying direction, then press [OK].

## 6 Select “Yes”, then press [OK].

- If you select “No”, you can change the selection. (⇒ 41, To change the selection)

## 7 Set other settings, then press [OK]. (⇒ 41, Setting the copying options)

## 8 Select “Yes”, then press [OK].

## To register the external HDD (USB HDD) (⇒ 56)

## To copy HD Video (AVCHD) to the DVD-R in High Definition (⇒ 47)

## To copy video files (⇒ 47)

## Release the disc protection(⇒ 69)



- If you wish to choose the audio language, select the language from “Multi Audio” of “Preferred Multi Audio” before copying (⇒ 62).
- Simultaneous operation is not possible while copying with finalising or creating Top Menu.
- You cannot copy the following titles.
  - **USB HDD** Protected titles
  - **USB HDD** HD Video (AVCHD)



## To change the selection

- 1 Select "No", then press [OK] in step 6 (⇒ 40).  
e.g., **HDD** → **DVD-RW**

The order of copying

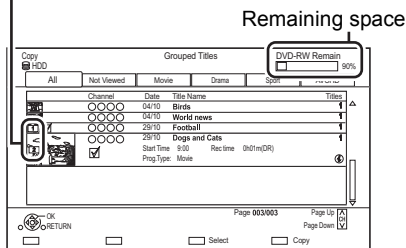

## 2 To change the selected titles:

Select the title, then press the yellow button. Repeat this step to select titles.

To change the picture quality:

**HDD** → **RAM** **DVD-R** **DVD-RW** **+R** **+RW**

- 1 Select the title, then press [OPTION].
- 2 Select "Conversion Select", then press [OK].
- 3 Select the picture quality, then press [OK].  
Repeat steps if necessary.
- 3 Press the blue button.
- 4 Go to step 6. (⇒ 40)

## About screen icons on the Video Menu

Refer to "Screen icons". (⇒ 30)

## Setting the copying options

- 1 Select the item in step 7 (⇒ 40).  
e.g.,

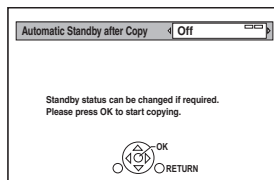

- 2 Press [◀, ▶] to change the settings.

### • Automatic Standby after Copy On:

This unit is turned to standby mode when it is not operated for approximately 5 minutes after completing copy.

### • Subtitles

#### Automatic:

Subtitles will be recorded if they are included in the title.



- If you wish to choose the subtitle, select the language from "Subtitles" of "Preferred Subtitles" before copying (⇒ 62).

### • Finalise

#### On:

**DVD-R** **DVD-RW** **+R** The discs become play-only and you can also play them on other DVD equipment.

### • Create Top Menu

#### On:

**+RW** You can play the disc on other DVD equipment.



- You can perform "Finalise" or "Create Top Menu" later. (⇒ 70)
- About limitations on "Audio Description". (⇒ 8)

## Copying titles

### Copying from media other than HDD with Video Menu

RAM +RW → HDD

- 1** Insert a disc.  
The menu screen appears. (⇒ 32)
- 2** Select “Play Video”, then press [OK].
- 3** Select the title.
  - Multiple selection (⇒ 40)
- 4** Press the blue button.

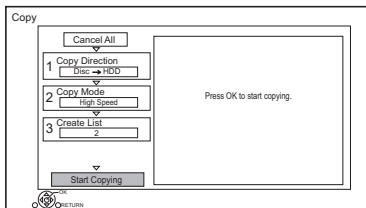

- To change the detailed settings for copy, refer to “Copying titles with copying list”. (⇒ right)

- 5** Select “Start Copying”, then press [OK].
- 6** Select “Yes”, then press [OK].

### Copying titles with copying list

HDD ↔ USB HDD

HDD → RAM DVD-R DVD-RW +R +RW

RAM +RW → HDD

- 1** HDD ↔ USB HDD:
  - 1 Press [FUNCTION MENU].
  - 2 Select “Copy Menu” in “Copy Video”, then press [OK].

**Except “HDD ↔ USB HDD”:**

- 1 Insert a disc.  
The menu screen appears. (⇒ 32)
- 2 Select “Copy”, then press [OK].

- 2** Set the copy direction.
  - 1 Select “Copy Direction”, then press [▶] (right).
  - 2 Set “Source” and “Destination”.
  - 3 Press [◀].

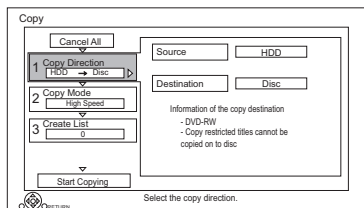

- 3** Set the recording mode (⇒ 9).
  - 1 Select “Copy Mode”, then press [▶] (right).
  - 2 Set “Recording Mode”.
  - 3 Press [◀].

#### 4 Register titles for copy.

- 1 Select "Create List", then press [▶] (right).
- 2 Select "New item", then press [OK].
- 3 Select the title, then press the yellow button.

Repeat this step to select titles.

e.g., **HDD**

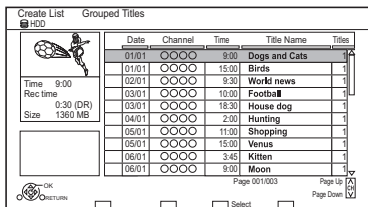

• To change the appearance of the list or show information of the title

- 1 Press [OPTION].
- 2 Select the item, then press [OK].



- The titles will be copied in the order of the copying list. If you want to specify the order, edit the copying list after the titles are selected. (⇒ 44, Editing the copying list)

- 4 Press [OK].
- 5 Press [◀].

Data size of each title

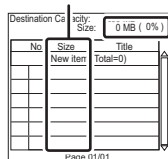

Data size recorded to the copy destination

#### 5 Make other settings.

- 1 Select "Other Settings", then press [▶] (right).

e.g.,

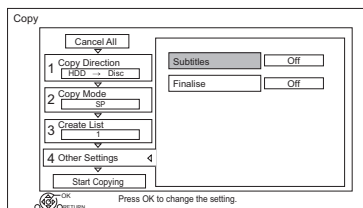

• This screen does not appear depending on the copying mode. (⇒ go to step 6)

- 2 Select the copying option, then press [OK]. (⇒ 41, Setting the copying options)
- 3 Select the item, then press [OK].
- 4 Press [◀].

#### 6 Select "Start Copying", then press [OK].

#### 7 Select "Yes", then press [OK].

#### To cancel all registered copying settings and lists

After performing step 1

- 1 Select "Cancel All", then press [OK].
- 2 Select "Yes", then press [OK].



- Titles in the grouped titles and other titles cannot be registered simultaneously.
- **RAM** Radio programme cannot copy.
- About limitations on "Audio Description". (⇒ 9)

## Copying titles

### Editing the copying list

- 1 Select the title after step 4-4 (⇒ 43).

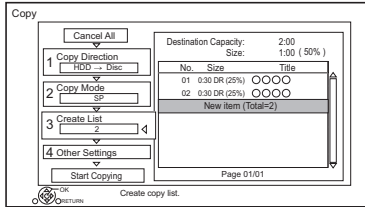

- 2 Press [OPTION].
- 3 Select the item, then press [OK].

#### Delete All:

All titles that you registered to copy are deleted.

#### Add:

Add new items to the copying list.

- 1 Select the titles with the yellow button.
- 2 Press [OK].

#### Delete:

Selected titles are deleted.

- Select the title, then press the yellow button before step 2.
- Repeat this step to select titles.

#### Move:

Change the order of items on the copying list.

- Select the title to move before step 2.
- Select the destination, then press [OK].

### Screen icons



Titles that cannot be copied in high speed mode



Titles that cannot be copied



Title contains photos

- Photos cannot be copied.



(NTSC)

Title recorded using a different encoding system from that of the unit.



(PAL)

- Titles displaying these marks cannot be selected.

### About other screen icons (⇒ 30)

## Notes for copying

### High speed copy

High Speed Copying is the process of copying a title to disc in high speed while maintaining the original record mode and recording length.

- Converting the recording mode will result in a normal speed copy.
- The following recording mode and media combinations support high speed copying.

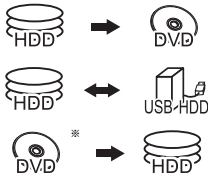
Original title's recording mode	Media
DR HG HX HE HL HM	
XP SP LP EP FR	 * DVD-RAM only

- High speed copy is possible only when there is enough recording capacity on the destination media.



- It is impossible to copy at high speed in the following cases:
  - **HDD** → **DVD-R** **DVD-RW** **+R** **+RW** :
    - Titles that contain many deleted segments
  - **HDD** → **+R** **+RW** :
    - Titles recorded in "EP" mode and "FR (recordings 5 hours or longer)" mode
    - Titles recorded in 16:9 aspect

### Normal speed copy

- **DVD-R** **DVD-RW** **+R** **+RW** You cannot copy to the disc in the following cases.
  - When there is not enough free space on the HDD.
  - When the number of titles recorded on the disc will exceed its maximum limit if copying is performed. (⇒ 8)
- Copying will continue up to the point cancelled.
  - **DVD-R** **DVD-RW** **+R** **+RW** If copy is cancelled during the step while temporarily copying to the HDD, then nothing will be copied.
  - **DVD-R** **DVD-RW** **+R** **+RW** Even if the title was not copied to the disc, the amount of remaining writable disc space becomes less.
- When copying title recorded in 1080/50p or 1080/60p, it cannot copy in progressive.

### Copying 3D programmes

- It may not display correctly in 3D when a copied 3D programme is played back. In such a case, change the "Signal Format" during the playback of the title. (⇒ 35)
- 3D information may not be copied.

### About maintaining the chapter mark

- The position of the chapter might shift slightly.
- Maximum number of chapters on the disc is limited.
  - **RAM** **DVD-R** **DVD-RW** : Approx. 1000
  - **+R** **+RW** : Approx. 254  
(Depends on the state of recording.)

## Copying titles

### Copying a finalised disc

DVD-V → HDD

While playing a disc, the content being played is copied to the HDD according to the set time.

- 1 Press [FUNCTION MENU].
- 2 Select "Copy Menu" in "Copy Video", then press [OK].
- 3 Set "Copy Mode".
  - 1 Select "Copy Mode", then press [▶] (right).
  - 2 Press [OK], then select the recording mode (XP/SP/LP/EP).
  - 3 Press [◀].
- 4 Set "Copy Time".
  - 1 Select "Copy Time", then press [▶] (right).
  - 2 Select "Time Setting", then press [OK].
  - 3 Select "On" or "Off".
 

**On:**  
Set the copying time.

    - Set a few minutes longer than the source title, in order to include the operation time before play begins.

**Off:**  
Copying all the content on the disc.
- 4 Press [◀].
- 5 Select "Start Copying", then press [OK].
- 6 Select "Yes", then press [OK].
  - When the Top Menu is displayed: Select the title you want to start copying, then press [OK].



After the last title on the disc has finished playing the Top Menu is recorded until the set time is reached.

### To stop copying

Press [STOP ■].

- If stopped partway, copying will be up to that point.



- Operations and on-screen displays during copy are also recorded.

### Copying Title Playing

HDD → RAM DVD-R DVD-RW +R +RW

- 1 Play back the title to copy.
  - Multiple audio, subtitle displayed during playback will be copied.
    - Select the multiple audio with "Multi Audio" in the Basic Operation menu (⇒ 58)
    - Select the subtitles with "Subtitle Language" in the Basic Operation menu. (⇒ 58)
- 2 Press [OPTION].
- 3 Select "Copy Title Playing", then press [OK].
- 4 Select "Start", then press [OK].  
Copying will start from the beginning of the title regardless of the playing position.

### To stop copying

Press and hold [BACK/RETURN ⊖] for 3 seconds.



- You can record to or play HDD while high speed copying. Press [OK] to exit the screen display.
- Press [STATUS ⓘ] to confirm the current progress.
- **Speed and recording mode when copying**  
The high speed copy is performed if available. Refer to "Notes for copying". (⇒ 45)



- **RAM DVD-R DVD-RW +R +RW** When copying the titles in DR, HG, HX, HE, HL or HM modes, copy will be performed at normal speed in FR mode.
- When copying the titles in XP, SP, LP, EP or FR modes and the copy destination does not have enough space, copy will be performed at normal speed in FR mode.

## Copying HD Video (AVCHD) to the DVD-R in High Definition

You can copy HD Video (AVCHD) recorded on HDD to a DVD-R in High Definition quality.

**HDD** → **DVD-R**

- 1** Insert an unformatted DVD-R or DVD-R DL. The menu screen appears. (⇒ 32)
- 2** Select “Copy Video ( AVCHD ) to Disc”, then press [OK].
- 3** Go to step 4 on page 43, “Copying titles with copying list”.

### To copy HD Video (AVCHD) from other equipment

Refer to “Copying the HD Video (AVCHD)”. (⇒ 54)



- When a disc is named, formatting will be automatically performed. Therefore, do not name a disc before this operation. (⇒ 69, Disc Name)
- Discs will be automatically finalised after copy.
- The following HD Videos (AVCHD) cannot be copied to the disc in high definition.
  - Exceeding 18 Mbps
  - 1080/50p or 1080/60p
  - Without the AVCHD information (video recorded with certain non-Panasonic equipment, etc.)
- 3D video may not be copied correctly.

## Copying video files

**USB**



**HDD**

- 1** On the video list screen: Select the file or folder.

e.g.,

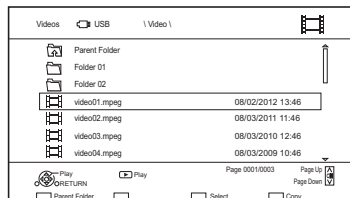

- Multiple selection (⇒ 40)

- 2** Press the blue button.
- 3** Select “Yes”, then press [OK].

### To stop copying

Press and hold [BACK/RETURN ⊕] for 3 seconds.



- While copying, no other operations can be performed. Timer recordings will not proceed.
- All files in the folder will be copied.
- The names of folders/files cannot be changed after they are copied to the HDD. We recommend that you create a folder with an easily identifiable name on a PC or other device first and use the folder to perform copying.
- Up to 1000 files can be copied at once.

# Playing photos



※1 “For data files (⇒ 9)” only (JPEG, MPO)

※2 **RAM** **DVD-R** **+R** only

## 1 **HDD**

- 1 Press **[FUNCTION MENU]**.
- 2 Select “Photo” in “Contents on HDD”, then press **[OK]**.

Except **HDD**

- 1 Insert or connect the media.  
The menu screen appears. (⇒ 32)
- 2 Select “View Photos”, then press **[OK]**.

## 2 Select the folder, then press **[OK]**.

- ## 3 Select the photo, then press **[OK]**.
- Press **[◀, ▶]** to display the previous or next photo.

## Photo Menu screen

e.g., **HDD**

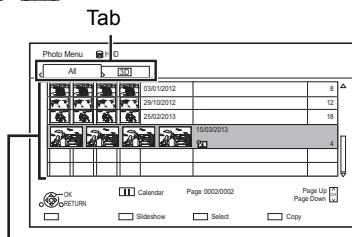

Photos imported to the HDD (⇒ 51) are managed using folders.

Folders and photos can be edited by pressing **[OPTION]**. (⇒ 50)

### • To select the tab

Press **[◀, ▶]**.

### • To start Slideshow



Refer to “Slideshow settings”. (⇒ 49)

### • **HDD**

**To display or exit the Calendar screen**

Press **[PAUSE III]**.

## Screen icons

<b>3D</b> (Tab)	3D photos (MPO) • Select from this tab to play back in 3D.
	Photo protected
	New photo which is not viewed



## Photo play option

- 1 While displaying a photo:  
Press [OPTION].
- 2 Select the item, then press [OK].

### Graphic Display Level

You can change the 3D position of the screen display, etc., during the 3D photo playback.

### Photo Menu

#### • Start Slideshow

You can start a slideshow.

#### • Rotate RIGHT/Rotate LEFT

- The information of the rotated photos will not be stored depending on the media.
- This function is not available during the 3D photo playback.

#### • Information

Information (shooting date etc.) is shown.

#### • Wallpaper

A photo being played back is registered as wallpaper on the FUNCTION MENU screen. (⇒ 18)

## Slideshow settings

- 1 On the Photo Menu screen:  
Press the green button.

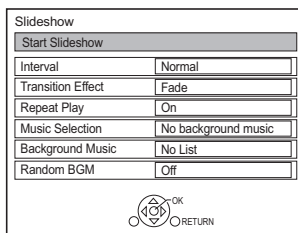

- 2 Select the item, then press [OK].

### Start Slideshow

#### Interval

Set up the time until the next photo is to display.

#### Transition Effect\*

Effect for the next photo to display can be set.

#### Repeat Play

#### Music Selection\*

Select background music on (either from HDD or USB) or off.

#### Background Music\*

Select background music from HDD or USB (Folder).

#### Random BGM\*

Play back the BGM (Background Music) in random order.

\* This function is not available during the 3D photo playback.

### To pause the Slideshow

Press [PAUSE ■■■].

- Press [PAUSE ■■■] again to restart.

### To stop the Slideshow

Press [BACK/RETURN ⊖].

# Editing photos



\* **RAM** only

- 1** On the Photo Menu screen:
  - To edit the folder:**  
Select the folder.
  - To edit the photo:**
    - 1 Select the folder, then press [OK].
    - 2 Select the photo to edit.
  - **To select multiple folders or photos**  
Press the yellow button when selecting the folder or photo.  
A check mark  is displayed. Repeat this step.
    - Press the yellow button again to cancel.
- 2** Press [OPTION].
  - Selectable items will change depending on the media and the type of file.

- 3** Select the item, then press [OK].

## Enter Folder Name

Refer to “Entering text”. (⇒ 71)

## Combine Folders

**HDD**

## Delete Folder

## Move Photos

**HDD**

Select “Move to new folder” or “Move to another folder”, then press [OK].

- If “Move to another folder” is selected, set a destination folder.

## Delete Photos

## Set up Protection

**RAM**

appears.

- Even if the protection is set, the photo may be deleted by another unit.

## Cancel Protection

**RAM**

# Copying photos



\*1 “For data files (⇒ 9)” only (JPEG, MPO)

\*2 **RAM** **DVD-R** **+R** only



- The name of the copied photos will be changed.

## Selecting and copying the photos

**HDD** → **RAM**

**RAM** **DVD-R** **+R** **CD** → **HDD**

**USB** **HDD** **USB** → **HDD** **RAM**

- On the Photo Menu screen:  
**To copy the folder:**  
Select the folder, then press the blue button.

### To copy the photo:

- Select the folder, then press [OK].
- Select the photos to copy, then press the blue button.

### • To select multiple folders or photos

Press the yellow button when selecting the folder or photo.

A check mark  is displayed. Repeat this step.

- Press the yellow button again to cancel.

### If the copy destination selection screen is displayed:

Select the copying destination, then press [OK].

- Select “Yes”, then press [OK].  
Copying starts.

### To stop copying

Press and hold [BACK/RETURN ] for 3 seconds.

## Copying automatically

**USB** **HDD** **RAM** **DVD-R** → **HDD**  
**+R** **CD** **USB**

Newly added photos will automatically be copied to the HDD.

- Insert the media.  
The menu screen appears. (⇒ 32)
- Select “Copy New Photos”, then press [OK].  
e.g., **USB**

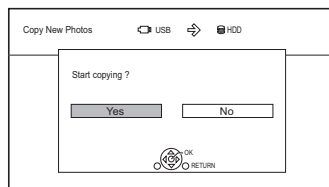

- Select “Yes”, then press [OK].  
Copying starts.
- Once the copy is completed, select “Yes” or “No”, then press [OK].

### To stop copying

Press and hold [BACK/RETURN ] for 3 seconds.



- Photos without shooting date will be categorised using the creation date.

# Playing music



※1 “For data files (⇒ 9)” only

※2 **DVD-R** **+R** only

## Playing music CD (CD-DA)

### CD (CD-DA)

Insert the disc.

Playback will automatically start.

e.g.,

Music Menu		Track List	
@CD		Track 1 3:43	
○○○○			
No.	Track Name	Play Time	
01	○○○○	○○○○	
02	○○○○	○○○○	
03	○○○○	○○○○	
04	○○○○	○○○○	
05	○○○○	○○○○	

### To play other music (track)

Select the item, then press [OK].

## Playing music file on the media

**USB HDD** **DVD-R** **+R** **CD** **USB**

- 1 Insert or connect the media.  
The menu screen appears. (⇒ 32)
- 2 Select “Play / Copy Music”, then press [OK].  
The music list screen appears.

e.g.,

Music		USB	1 Music 1
Parent Folder	Folder 01	Folder 02	
music01.mp3	music02.mp3	music03.mp3	music04.mp3
<input type="checkbox"/> Play <input type="checkbox"/> DIRECT/URL <input type="checkbox"/> Parent Folder <input type="checkbox"/> Select <input type="checkbox"/> Copy			

- 3 Select the item, then press [OK].
  - Repeat this step if necessary.
 Playback will start.



- The track/artist/album name will be displayed if the information is contained in music file.

## Screen icons

	Folder
	Music
	Move to the parent folder

## Playing music file on the HDD

### HDD

- 1 Press [FUNCTION MENU].
- 2 Select “Music” in “Contents on HDD”, then press [OK].  
The music list screen appears.
- 3 Go to step 3 (⇒ left), “Playing music file on the media”.

## Operations during music play

### Stop

Press [STOP ■].

### Pause

Press [PAUSE ■■].

- Press [PLAY/× 1.3 ▶] to restart play.

### Search

Press [SLOW/SEARCH ◀◀] or [SLOW/SEARCH ▶▶].

- Press [PLAY/× 1.3 ▶] to restart play.

### Skip

Press [SKIP ◀◀] or [SKIP ▶▶].

### Repeat Play/Random

Refer to “Repeat Play” or “Random” in Basic Operation menu (⇒ 58).

### Sound Effects

Refer to “Sound Effects” in Sound Settings menu (⇒ 59).

### To play music continuously even if the Power off link works

Refer to “Playing music continuously even after turning off power to the TV”. (⇒ 57)

# Copying/Deleting music



※1 “For data files (⇒ 9)” only

※2 **DVD-R** **+R** only

## Copying

**USB** **HDD** **DVD-R** **+R** **CD**※3 **USB** → **HDD**

※3 Except **CD** (**CD-DA**)

- 1 On the music list screen:  
Select the file or folder.

e.g.,

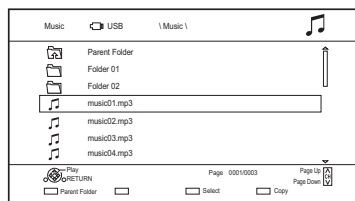

- 2 Press the blue button.
- 3 Select “Yes”, then press [OK].

## To stop copying

Press and hold [BACK/RETURN ⊖] for 3 seconds.

## Multiple selection

Select the file or folder, then press the yellow button.

A check mark ✓ is displayed. Repeat this step.

- Press the yellow button again to cancel.



- While copying, no other operations can be performed.  
Timer recordings will not proceed.
- All files in the folder will be copied.
- Up to 1000 files can be copied at once.

## Deleting

**HDD**

- 1 On the music list screen:  
Select the file or folder.  
• Multiple selection (⇒ left)
- 2 Press [DELETE].
- 3 Select “Yes”, then press [OK].



- All files in the folder will be deleted.

# Copying the HD Video (AVCHD)

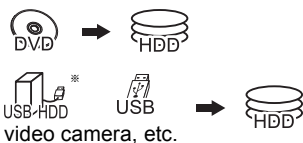

\* "For data files (⇒ 9)" only  
e.g., Connecting to the Panasonic video camera

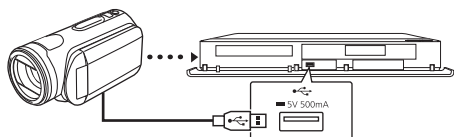

**USB connection cable**  
(optional)

- 1** Connect the video camera or insert the media.
  - Make the video camera ready for data transfer.The menu screen appears. (⇒ 32)
- 2** Select "Copy Video ( AVCHD )", then press [OK].
- 3** Select the title, then press the yellow button. A check mark  is displayed. Repeat this step.
  - Press the yellow button again to cancel.  
(All the recordings on the same date become a title.)
- 4** Press [OK].
- 5** Select "Start", then press [OK].

## To stop copying

Press and hold [BACK/RETURN Ⓞ] for 3 seconds.

## Screen icons

- N (NTSC)** Title recorded using a different encoding system from that of the unit.
- P (PAL)**
  - Titles displaying these marks cannot be selected.

# Registering the external HDD (USB HDD)



\* “For recorded titles (⇒ 9)” only

If you intend to move recorded titles to a USB HDD, the USB HDD must be registered to this unit first.

## Limitation information

- A USB HDD with a capacity of less than 160 GB cannot be used.
- Registering of a USB HDD will format the USB HDD and all the content already recorded will be deleted.
- Up to eight USB HDDs can be registered on this unit. If you have already registered eight USB HDDs, it will be necessary to delete one or more of them before registering a new USB HDD.
- Registered USB HDDs cannot be used with devices other than this unit.

## Regarding the external HDD (USB HDD)

### Please use a confirmed USB HDD.

For the latest information on confirmed USB HDDs, please check the following website.

<http://panasonic.jp/support/global/cs/>

- Certain non-confirmed USB HDDs cannot be used with this unit.
- If a problem occurs with the USB HDD, please contact the manufacturer of the device.

## Connecting the USB HDD

Connect this unit with optional USB HDD.

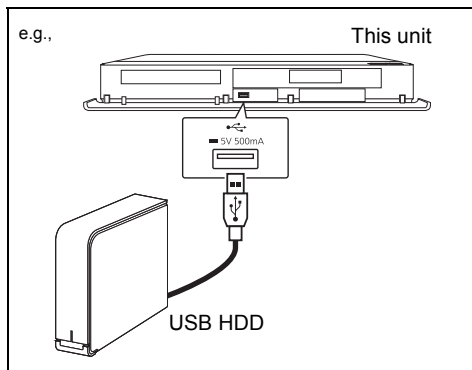

- Do not connect additional HDDs using a USB hub.
- For details about connection method, refer to the instructions supplied with the USB HDD.

## Registering the external HDD (USB HDD)

### Disconnecting the USB HDD

Disconnecting without following this procedure may result in the loss of recorded content from the USB HDD or the internal HDD.

- 1** Press [FUNCTION MENU].
- 2** Select "Basic Settings" in "Setup", then press [OK].
- 3** Select "Settings for USB HDD" in "HDD / Disc / USB HDD", then press [OK].
- 4** Select "USB HDD Disconnection", then press [OK].
- 5** Select "Yes", then press [OK].
- 6** Disconnect the USB HDD from this unit.

### Registering the USB HDD

- If the registering screen appears when connecting the USB HDD, go to step 5.

- 1** Press [FUNCTION MENU].
- 2** Select "Basic Settings" in "Setup", then press [OK].
- 3** Select "Settings for USB HDD" in "HDD / Disc / USB HDD", then press [OK].
- 4** Select "USB HDD Registration", then press [OK].
- 5** Select "Yes", then press [OK].
- 6** When the registering is complete, message screen appears.  
Press [OK].
- 7** The confirmation screen appears.  
Press [OK].

---

### To cancel all USB HDD registrations (⇒ 63)

---



- It is not possible to play back the content on the USB HDD whose registration has been cancelled.
- You can check the registration number of the USB HDD on the Video Menu. (⇒ 29)



# VIERA Link functions

## What is VIERA Link?

VIERA Link is a convenient function which will link the operations of this unit and a Panasonic TV (VIERA) or an amplifier/receiver. You can use this function by connecting the equipment with the HDMI cable. See the operating instructions for connected equipment.

### Automatic input switching/ Power on link

When the following operations are performed, the input channel of the TV will be automatically switched and the screen of this unit will be displayed. Additionally when the TV is off, the TV will automatically turn on.

- When play starts on this unit
- When an action that uses Video Menu etc, is performed

### Power off link

When you set the TV to standby mode, this unit is also automatically set to standby mode.

- Power off link function does not work when recording, copying etc.

### Playing music continuously even after turning off power to the TV

The following operations make it possible to keep the power of the unit on and to play music continuously.

When the unit is directly connected to an amplifier/receiver.

- 1 While playing music  
Press [OPTION].
  - 2 Select "TV Power Off", then press [OK].
- Sound may be discontinued for several seconds when the power to the TV is turned off.

### Easy control only with Panasonic TV's remote control

You can operate this unit using the TV remote control.

Refer to the operating instructions of the TV about the buttons that you can use.



- VIERA Link, based on the control functions provided by HDMI which is an industry standard known as HDMI CEC (Consumer Electronics Control), is a unique function that we have developed and added. As such, its operation with other manufacturers' equipment that supports HDMI CEC cannot be guaranteed.
- These functions may not work normally depending on the equipment condition.
- Use the remote control supplied with this unit if you cannot operate this unit using buttons on the TV remote control.

# Playback menu

A variety of playback operations and settings can be performed from this menu.

Available options differ depending on the playing contents and the condition of the unit.

**1** Press [DISPLAY].

e.g.,

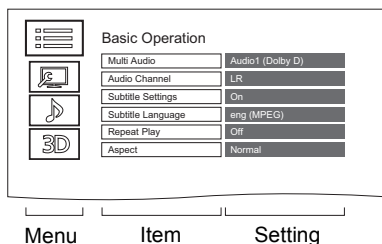

**2** Select the menu, then press [OK].

**3** Select the item, then press [OK].

**4** Change the setting.

## To clear the Playback menu

Press [DISPLAY].

## Language

ENG	English	JPN	Japanese	ARA	Arabic
FRA	French	CHI	Chinese	HIN	Hindi
DEU	German	KOR	Korean	PER	Persian
ITA	Italian	MAL	Malay	IND	Indonesian
ESP	Spanish	VIE	Vietnamese	MRI	Maori
NLD	Dutch	THA	Thai	BUL	Bulgarian
SVE	Swedish	POL	Polish	RUM	Romanian
NOR	Norwegian	CES	Czech	GRE	Greek
DAN	Danish	SLK	Slovak	TUR	Turkish
POR	Portuguese	HUN	Hungarian	*	Others
RUS	Russian	FIN	Finnish		

## Basic Operation

### Soundtrack\*

Show or change the soundtrack.

### Multi Audio

Switch in the case of multiple audio.

### Audio Channel

Change audio (LR/L/R) during playback.

### Subtitle Settings\*

Turn the subtitle on/off, and change the language depending on the media.

#### Subtitle Settings

#### Subtitle Position

#### Subtitle Luminance

### Subtitle Language

Select the subtitle language in the case of multiple languages.

### Angle\*

Change the number to select an angle.

### Repeat Play

Select the item which you want to repeat.

### Random

Select whether to play random or not.

### Video

The original video recording method (MPEG-4 AVC etc.) appears.

### Aspect (⇨ 71)

\* With some discs, you may only be able to make changes using the menus on the disc.

## Picture Settings

### Picture Type

Select the picture type.

### Sharpness Adjustment

### Noise Reduction

### Luminance/Colour Adjustment

### Progressive

Select the method of conversion for progressive output to suit the type of title being played.

- **Auto**

Automatically detects the film and video content, and appropriately converts it.

- **Video**

Select this setting when the content is distorted if "Auto" is selected.

- **Film**

Select this if the edges of the film content appear jagged or rough when "Auto" is selected. However, if the video content is distorted, then select "Auto".

### Reset to Default Picture Settings

Restores the default settings of the Picture Settings menu.

## 3D Settings (⇒ 35)

### Signal Format

### Graphic Display Level



- The menu is not displayed when playing photos.

## Sound Settings

### Sound Effects

- This function is effective when "Digital Audio Output" is set to "PCM". (⇒ 64)

#### Night Surround

Enjoy a movie with powerful sound even when the volume is kept low at night.

#### Re-master 1-2

Sound becomes more natural by adding higher frequency signals not recorded on the track.

### Dialogue Enhancer

The volume of the centre channel is raised to make dialogue easier to hear.

# Basic Settings

You can change the unit's settings of Digital TV Tuning, Sound, Display, Connection, Network etc. in the menu.

- 1 Press [FUNCTION MENU].
- 2 Select "Basic Settings" in "Setup", then press [OK].

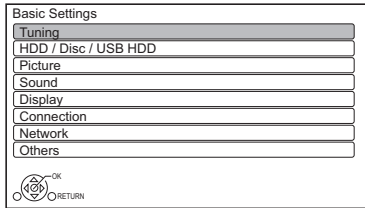

- 3 Select the menu, then press [OK].
- 4 Select the item, then make the setting.

## To return to the previous screen

Press [BACK/RETURN ⊖].

## Tuning

### Favourites Edit

You can create four favourites of channels for making viewing and recording easier.

**After editing as follows, save the Favourites.**  
Press [BACK/RETURN ⊖], then press [OK].

- To select the other Favourites list:  
Press the green button.
- To add channels to the Favourites list:  
Select the channel in the "All DVB Channels" column, then press [OK]. Repeat this step.
  - Yellow: Add all the available channels to the Favourites. (This function is available only when there are no channels in the "Favourites".)
- To change the order of the channels list:
  - 1 Select the channel in the "Favourites" column to move, then press the green button.
  - 2 Select the new position, then press the green button.
- To delete channels:  
Select the channel in the "Favourites" column, then press [OK].
  - Yellow: Delete all channels.
- To change the name of the Favourites list:
  - 1 Press the red button in the "Favourites" column.
  - 2 Press [▲, ▼, ◀, ▶] to select a character, then press [OK].  
Repeat this step to enter other characters.
    - Red: Delete a character.
    - Blue: Delete all characters.
  - 3 Press [BACK/RETURN ⊖].

## Auto Setup

You can restart the Auto Setup. (⇒ 16)

PIN is required when you have locked channels.  
(⇒ right, Child Lock List)

Select "Yes", then press [OK].



- The timer recording programmes are cancelled.
- If you perform "Channel Sorting by Region" (⇒ below), you can sort the channel list best suited to your region after Auto tuning is finished.

## Settings for Channels

### Channel List

You can edit the channel list.

- To hide unwanted channels
  - 1 Select the channel.
  - 2 Press [OK].  
The check mark is removed.
    - Yellow: Reveal all channels.
- To change the channel number assignment
  - 1 Select the channel to change, then press the green button.
  - 2 Enter the channel number to reassign with the number buttons.
  - 3 Press [OK].
- To set the channel manually
  - 1 Press the red button.
  - 2 Refer to "Manual Tuning". (⇒ below)

### Channel Sorting by Region

If you want to sort the channel list best suited to your region, follow the on-screen instructions to select the region you live in. Normally, you should select "Best signal quality (All Regions)".

### Manual Tuning

You can add new channels manually.

- 1 Press [▲, ▼] to select the frequency.
  - Adjust the frequency by checking the signal strength and signal quality displays.
- 2 Press [OK] to start scan.
  - The set channel is displayed in the table.

## Update Channel List

You can update the channel list to the latest one.

### Signal Condition

You can check the quality and strength of signals.

Press [CH ^ v] to select the channel.



- The channels you can receive are affected by weather conditions, seasons, time (day/night), region, length of the cable that is connected to the aerial, etc.
- When the signal is too strong (red bar), reduce the signal amplification at your aerial. (For details, consult your dealer.)

### New Channel Message

Set whether to obtain the information automatically when a new DVB channel is added.

## Child Lock

You can restrict the viewing/playback/recording of channels unsuitable to children.

- PIN is required to change. (⇒ 19)

### Child Lock List

- 1 Select the channel to lock.
- 2 Press [OK].
  -  is displayed.
    - Press [OK] again to cancel.
    - Green: Lock all channels.
    - Yellow: Unlock all channels.

### Player PIN Control

You can restrict the viewing of Digital teletext (MHEG) unsuitable to children.

## Basic Settings

### Preferred Multi Audio

#### Multi Audio

Select the language for multi broadcast.

If the selected language is not available, the original language will be selected.

#### Audio Description

(When Audio Description is available in the programme)

When "Automatic" is selected, Audio Description will be set as default while watching.



- When "Dolby Digital / Dolby Digital Plus", "DTS", "MPEG" or "HE-AAC" is set to "Bitstream", the Audio Description may not work. Set them to "PCM" (⇒ 64, Digital Audio Output).
- About limitations on "Audio Description". (⇒ 9)

### Preferred Subtitles

#### Subtitles

Choose the subtitle language for broadcast. If the selected language is not available, then the original language will be selected.

## HDD / Disc / USB HDD

### Settings for Playback

#### Soundtrack

Select the audio language.

- Enter a code with the number buttons when you select "Other \*\*\*\*". (⇒ 79, Language code list)

#### Subtitles

Select the language for subtitle.

- Enter a code with the number buttons when you select "Other \*\*\*\*". (⇒ 79, Language code list)

#### Menu

Select the language for disc menus.

- Enter a code with the number buttons when you select "Other \*\*\*\*". (⇒ 79, Language code list)

### DVD-Video Parental Control

Set a rating level to limit DVD-Video play.

- PIN is required to change. (⇒ 19)

### Child Lock

You can restrict playback of the following titles:

- Titles that are recorded with guidance information
- Titles restricted by Child Lock List (⇒ 61)  
(Titles with  icon in Video Menu, etc.)
- PIN is required to change. (⇒ 19)

### Settings for Recording

#### REWIND LIVE TV

Turn on/off the REWIND LIVE TV function.

- When "Automatic Standby" is set to "Off" (⇒ 66), "On" cannot be selected.

#### Aspect for Recording

Sets the aspect ratio when recording or copying except in DR mode.

- "HG", "HX", "HE", "HL" or "HM" mode:  
If "Automatic" is selected, the title will be recorded with the original aspect ratio.
- "XP", "SP", "LP" or "FR (recordings 5 hours or longer)" mode:  
If "Automatic" is selected, the title will be recorded with the original aspect ratio at the time when recording started (including when recording started at a commercial, etc.).
- "EP" or "FR (recordings 5 hours or longer)" mode:  
If "Automatic" is selected, aspect is fixed to 4:3.
- In the following cases, aspect is fixed to 4:3.
  - When copying to a +R, +R DL and +RW.

#### Chapter Creation

Set the Chapter Creation method.

- Even if "Automatic" is selected, depending on the programme to be recorded, the chapter may not be created correctly.

#### Disc Speed for High Speed Copy

Select the speed of high-speed copying.

## HDD Management

Press and hold [OK] for 3 seconds to show the following settings.

### Delete all titles

Delete all recorded programmes and AVCHD on the built-in HDD.

- Delete does not work if one or more titles are protected.

### Delete all videos ( MP4 / Xvid / MKV )

Delete all videos (MP4/Xvid/MKV) on the built-in HDD.

### Delete all photos

Delete all photos on the built-in HDD.

### Delete all music

Delete all Music on the built-in HDD.

### Format HDD

**Formatting deletes all contents on the built-in HDD, and they cannot be restored. Check carefully before proceeding.**

## Settings for USB HDD

### USB HDD Registration

Register the USB HDD. (⇒ 56)

### USB HDD Disconnection

This function puts the USB HDD in a state in which it can be safely disconnected. (⇒ 56)

### USB HDD Management

Press and hold [OK] for 3 seconds to show the following settings.

#### Delete all titles

Delete all titles on the USB HDD.

- Delete does not work if one or more titles are protected.

#### Format USB HDD

**Formatting deletes all contents, and they cannot be restored. Check carefully before proceeding.**

## Cancellation of all USB HDD Registrations

This function cancels the registrations of all the USB HDDs registered on this unit.

Only do this if you are going to dispose of this unit.



- Before operation, perform "USB HDD Disconnection" (⇒ left) and remove the USB HDD.

## Picture

### Still Mode

Select the type of picture shown when you pause play.

- Field:

Select if jittering occurs when "Automatic" is selected. (The picture is coarser.)

- Frame:

Select if small text or fine patterns cannot be seen clearly when "Automatic" is selected. (The picture is clearer and finer.)

## Sound

### Dynamic Range Compression

To lower the dynamic range for playback (e.g., at night).

- This does not work depending on broadcasts and recorded titles.

### Downmix

Select the downmix system of multi-channel to 2-channels sound.

- Select "Surround encoded", when the connected equipment supports the virtual surround function.
- There is no effect on "Bitstream" via HDMI AV OUT terminal.
- The audio will be output in "Stereo" in the following cases.
  - AVCHD playback

### Bilingual Audio Selection

Select whether to record the audio type ("M1" or "M2") when:

- File Conversion (⇒ 38)
- Copying to a DVD-R, DVD-RW, +R and +RW.

## Basic Settings

### Digital Audio Output

#### Dolby Digital/Dolby Digital Plus

#### DTS

#### MPEG

#### HE-AAC

Select the audio signal to output.

- Select "PCM" when the connected equipment cannot decode the respective audio format.
- Not making the proper settings may result in noise.

#### System Volume Adjustment

If the volume of a programme being watched through this unit is different than the volume of a programme being watched directly on the TV, changing this setting may reduce the gap. (This function works only while you are watching a programme or playing back a programme recorded in DR mode with this unit.)

### Audio Delay

Mis-sync between the video and audio is corrected by delaying the audio output.

## Display

### On-Screen Information

Select the time until the channel information screen (⇒ 19) disappears automatically.

### Front Panel Display

Changes the brightness of the front panel display.

- If "Automatic" is selected, the display turns dark during play and disappears when the unit is in standby mode. While using this mode, the standby power consumption can be reduced.
- When "Quick Start" is set to "Off" or "Timer Setting for Quick Start" (⇒ 66), this function is fixed to "Automatic".

### Screen Saver

This is to prevent image retention on the screen.

## Connection

### 3D Settings

#### 3D Type

If 3D video cannot be played back in 3D, you may be able to play it in 3D by changing the setting.

- Change the settings for 3D on the TV also when "Side by side" is selected.

#### 3D AVCHD Output

If 2D AVCHD video is recognised as 3D video and cannot be played back correctly, you may be able to play it by changing the setting.

#### 3D Playback Message

Set to display or hide the 3D viewing warning screen.

### TV Aspect

Set to match the type of TV connected.

- 16:9:  
When connected to a 16:9 widescreen TV.

- 4:3:  
Side picture is trimmed for 16:9 picture.



The pictures may be shown in the letterbox style depending on the content.

- Letterbox:  
Black bands appear for 16:9 picture.



### Aspect for 4:3 Video

To play a 4:3 title, set how to show pictures on a 16:9 TV.

- 4:3:  
Picture output expands left or right.
- 16:9:  
Picture is output as original aspect with side panels.



## TV System

---

Set in accordance with the TV System for the connected TV.

## HDMI Connection

---

### HDMI Video Format

You can only select items compatible with the connected equipment.

- If "Automatic" is selected, the output resolution best suited to the connected TV (1080p, 1080i, 720p or 576p/480p) is automatically selected.
- To enjoy High Quality Video up-converted to 1080p, you need to connect the unit to 1080p compatible HDTV. If this unit is connected to an HDTV through other equipment, it must also be 1080p compatible.

### Deep Colour Output

This setting is for selecting whether to use Deep Colour output when a TV that supports Deep Colour is connected.

### Contents Type Flag

If "Automatic" is selected, the optimal method of playback depending on the TV (e.g. cinema) will automatically be selected (only when the TV supports Contents Type Flag).

### VIERA Link

Select "Off" when you do not want to use VIERA Link.

## Network

### Easy Network Setting

Press [OK] to start Easy Network Setting. (⇒ 17)

### Network Settings

---

#### IP Address / DNS Settings

Check the connection of the network or set the IP address and DNS.

- To set the IP address and DNS
  - 1 Set "IP Address Auto-assignment" and "DNS-IP Auto-assignment" to "Off".
  - 2 Select the item, then press [OK] to show the respective setting.
- When the router's DHCP server function is not activated, check the numbers of other connected devices such as personal computers, then assign a number different from those of other devices for the "IP Address" and assign the same number for "Subnet Mask" and "Gateway Address".

#### Proxy Server Settings

Check and set the connection to the Proxy server.

- Press [OK] to show the respective setting.

#### Notice

Displays the terms of service for the cloud services.

- You must agree to the terms of use for the Internet function and the privacy policy.

## Basic Settings

### Others

#### Standby Settings

##### Quick Start

- On:  
It is possible to start quickly from standby mode.
- Off:  
Power consumption in standby mode is minimised. (⇒ 78)  
However, startup time from standby mode will be longer.
- Timer Setting for Quick Start:  
“Quick Start” is activated when the set time comes.



- If “Off” or “Timer Setting for Quick Start” is selected, the setting for “Front Panel Display” in “Display” is fixed to “Automatic”. (⇒ 64)

##### Automatic Standby

Set the time to turn the unit to standby mode automatically.

When the unit is not operating, the unit will be turned to standby mode once the set time has passed.

- When “REWIND LIVE TV” is set to “On” (⇒ 62), “Off” cannot be selected.

##### Automatic Standby after OTR

- On:  
This unit is turned to standby mode when it is not operated for approximately 5 minutes after completing “Automatic Stop” or “Recording Time” (⇒ 22).

##### Automatic Standby after Copy

- On:  
This unit is turned to standby mode when it is not operated for approximately 5 minutes after completing copy (⇒ 42, Copying from media other than HDD with Video Menu, Copying titles with copying list).

##### RF OUT ( Aerial Signal )

Set whether to output the broadcasting signal from RF OUT or not while in standby mode (When “Quick Start” is not activated).

- If “On” is selected, the broadcasting signal is output from this unit.

##### Remote Control

Change the remote control code on the main unit and the remote control if you place other Panasonic products close together.

- Use “DVD 1”, the factory set code, under normal circumstances.
  - 1 Select the code, then press [OK].
  - 2 While pressing [OK], press and hold the number button ([1] to [6]) for more than 5 seconds.
  - 3 Press and hold [OK] for more than 5 seconds.
  - 4 Press [OK].

## Clock

If the time is not set correctly, use the settings listed in the method below.

- Manual Setting
  - 1 Select "Off" of "Automatic", then press [OK].
  - 2 Select the item you want to change.
  - 3 Change the setting.
  - 4 Press [OK] when you have finished the settings.

## Owner ID

In order to prevent another person from using this unit if it is stolen, you can set a PIN and input your personal information (NAME, HOUSE NO, POSTCODE).

**Once the PIN has been set, you cannot return to the factory preset. Make sure not to forget this.**

## PIN Entry

You can set/change the PIN for parental control.

- 1 Enter your 4-digit PIN with the number buttons.
- 2 Enter the new 4-digit PIN with the number buttons.
  - **Make a note of PIN in case you forget it.**
 e.g.,

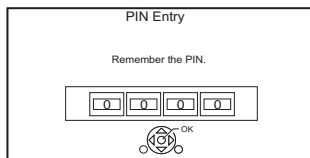

- 3 Press [OK].

## System Update

### Software Update in Standby

When you set this unit to standby mode, software (firmware) updates (⇒ 68) are downloaded automatically at the time you have specified.

### Software Update Now ( Broadcast )

Refer to "Software (Firmware) Update".  
(⇒ 68)

### Software Update Now ( Internet )

Refer to "Software (Firmware) Update".  
(⇒ 68)

### Software Licence

Information about the software licence is displayed.

## System Information

Display Software (firmware) version of this unit.

## Initialize

### Shipping Condition

All the settings except for some settings return to the factory preset.

- The timer recording programmes are also cancelled.

### Default Settings

All the settings other than the tuning settings, clock settings, disc language settings, parental control settings, remote control code, etc. return to the factory presets.

# Software (Firmware) Update

You cannot operate the unit until the update is complete. Don't remove the AC mains lead during the update. Removing the AC mains lead while the update is in progress may damage the unit.

## Update software (firmware) of this unit

Software of this unit can be updated automatically by the following methods at the specified time.

- **From broadcasts**

(Default setting is 3 a.m. ⇒ 67, Software Update in Standby)

- **From Internet**

Network connection and setting are required. (⇒ 15, 17)

**If a software (firmware) update is available, a notification is displayed.**

New software version has been found.  
The software will be updated automatically after this unit is switched to standby.  
Do not disconnect the AC mains lead.

Update of the software (firmware) will start when the unit is turned to standby mode.

**To update the software (firmware) immediately**

Use the "Software Update Now ( Broadcast )" function or "Software Update Now ( Internet )" function. (⇒ 67)



- It may take up to a few hours until the update is completed depending on the network environment.
- The timer recording always takes preference over the software (firmware) download; if the timer recording is scheduled to start, the downloading will be performed at the next opportunity.
- For the latest firmware update information, please refer to the Panasonic support site below.
- You can also download the latest software (firmware) from the following website.  
<http://panasonic.jp/support/global/cs/>

# Other operations

## Media management

RAM DVD-R DVD-RW +R +RW

- 1 Press [FUNCTION MENU].
- 2 Select "Media", then press [OK].
- 3 Select the media, then press [OK].
- 4 Select the management item, then press [OK].
  - Selectable items will change depending on the selected item and inserted media.

## Disc Name

RAM DVD-R DVD-RW +R +RW

This function is to name a disc.  
Refer to "Entering text". (⇒ 71)

- The disc name is displayed in the DVD Management window.
- **DVD-R** **DVD-RW** **+R** With a finalised disc, the name is displayed on the Top Menu.
- **+RW** The disc name is displayed only if you play the disc on other equipment after creating Top Menu.



- Do not perform this operation before copying HD Video (AVCHD) to DVD-R or DVD-R DL. (⇒ 47)

## Disc Protection

RAM

Select "Yes", then press [OK].

e.g.,

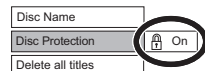

- To release the protection  
Repeat the same steps.
  - The screen icon will be switched to "Off".

## Delete all titles

RAM

- 1 Select "Yes", then press [OK].
- 2 Select "Start", then press [OK].



- Photo data (JPEG/MPO) or computer data cannot be deleted.

## Format Disc

RAM DVD-RW +RW +R (New disc only)

**Formatting deletes all contents (including computer data), and they cannot be restored. Check carefully before proceeding.**

- 1 Select "Yes", then press [OK].
- 2 Select "Start", then press [OK].
- 3 Press [OK].

## RAM To stop formatting

Press [BACK/RETURN ⊙].

- You can cancel formatting if it takes more than 2 minutes. The disc must be reformatted if you do this.



- **Do not disconnect the AC mains lead while formatting.**  
This can cause the disc unusable.
- The contents are deleted when you format a disc even if you have set protection.
- **RAM** Formatting normally takes a few minutes; however, it may take up to a maximum of 70 minutes.
- When a disc has been formatted using this unit, it may not be possible to use it on any other equipment.
- It will become DVD Video format when a DVD-RW recorded in DVD Video Recording format is formatted with this unit.

## Other operations

### Top Menu

**DVD-R** **DVD-RW** **+R** **+RW**

You can select the background for DVD-Video Top Menu.

Select the background, then press [OK].

### Auto-Play Select

**DVD-R** **DVD-RW** **+R** **+RW**

You can select whether to show the Top Menu after finalising or creating Top Menu.

Select "Top Menu" or "Title 1", then press [OK].

#### Top Menu:

The Top Menu appears first.

#### Title 1:

The disc content is played without displaying the Top Menu.

### Finalise

**DVD-R** **DVD-RW** **+R** (You can play the disc on compatible DVD players by finalising it on the unit.)

- 1 Select "Yes", then press [OK].
- 2 Select "Start", then press [OK].
- 3 Press [OK].

### After finalising

- **DVD-R** **+R** The disc becomes play-only and you can no longer record or edit.
- **DVD-RW** You can record and edit the disc after formatting.



- **Do not disconnect the AC mains lead while finalising.** This can cause the disc unusable.
- You cannot cancel finalising.
- Finalising takes up to 15 minutes (Up to 60 minutes in case of DVD-R DL and +R DL).
- Depending on the disc, it may take longer than displayed on the confirmation screen (approximately four times longer).
- You cannot finalise discs recorded on other manufacturer's equipment.
- **DVD-R** **DVD-RW** **+R** If you finalise discs recorded on Panasonic equipment other than this unit, the background selected as "Top Menu" may not be displayed.
- Discs finalised on this unit may not be playable on other players due to the condition of the recording.

### Create Top Menu

**+RW**

You can create Top Menu for displaying on other equipment.

Make selections from "Top Menu" and "Auto-Play Select" before creating Top Menu.

- 1 Select "Yes", then press [OK].
- 2 Select "Start", then press [OK].
- 3 Press [OK].



- You cannot use the Top Menu for playing on this unit.
- The created menu is deleted when you record or edit the disc.

### HOLD function

The HOLD function deactivates all buttons on the unit and remote control.

Press and hold [OK] and [BACK/RETURN ⊖] simultaneously until "X HOLD" appears on the front panel display.

### To cancel the HOLD function

Press and hold [OK] and [BACK/RETURN ⊖] simultaneously until "X HOLD" disappears.

## Entering text

### Preparation

- Show the "Enter Title Name" screen, etc.

- 1 Select a character, then press [OK].  
Repeat this step to enter other characters.

e.g.,

Name field: shows the text you have entered

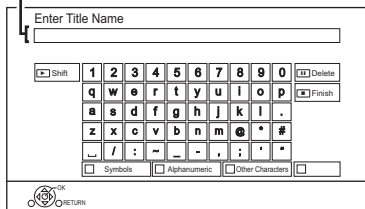

- Green: Enter Alphanumeric characters
- Red: Enter Symbols
- Yellow: Enter Other Characters, such as umlaut mark or accent grave
- [PAUSE ■■]: Delete a character
- [PLAY/× 1.3 ▶]: Shift the alphabetic characters on the screen to upper case/lower case

- 2 Press [STOP ■] (Finish).  
"Writing..." appears then the screen returns to the previous screen and so on.

### To end partway

Press [BACK/RETURN ⊕]. (Text is not added.)



- The maximum number of characters depends on the media.

## Switching the aspect ratio of the screen

When the image does not match the screen size of the TV, you can enlarge the image to fill the screen.

- 1 Press [OPTION].
- 2 Select "Playback Settings" in "Playback Menu", then press [OK].
- 3 Select "Aspect" in "Basic Operation", then press [OK].
- 4 Select the item, then press [OK].

### Normal:

Normal output

### Side cut:

The black bars on the right and left sides of the 16:9 image disappear and the image is enlarged.

### Zoom:

The black bars on the top and bottom sides of the 4:3 image disappear and the image is enlarged.



- This function does not work on 3D contents.
- The screen mode is switched to "Normal" in the following situations:
  - when you change the channel
  - when you start or end the playback of a title
  - when you switch the unit on or to standby mode.
- [DVD-V] "Side cut" does not have any effect.
- When "TV Aspect" (⇒ 64) is set to "4:3" or "Letterbox", the "Zoom" effect is disabled.

# Troubleshooting guide

**Before requesting service, make the following checks. If the problem still persists, consult your dealer for instructions.**

**Updating to the latest software (firmware) may solve the problem. (⇒ 68)**

## The followings do not indicate a problem with this unit:

- Regular disc rotating sounds or HDD rotating sounds.
- Poor reception due to atmospheric conditions.
- When you switch the unit on or to standby mode, there may be an unexpected sound.

## General operation

### The unit does not work.

- Check the connections. (⇒ 14)
- One of the unit's safety devices may have been activated.

Reset the unit as follows:

- 1 Press [⏻/⏪] on the main unit to switch the unit to standby.
  - If the unit does not switch to standby, press [⏻/⏪] on the main unit for about 3 seconds. The unit is forcibly switched to standby. Alternatively, disconnect the AC mains lead, wait one minute, then reconnect it.
- 2 Press [⏻/⏪] on the main unit to switch it on. If the unit still cannot be operated, consult the dealer.

### Cannot eject a disc.

- 1 Press and hold [⏻/⏪] on the main unit for at least 3 seconds when it is turned off.
- 2 Press and hold [OK], the yellow button and the blue button at the same time for more than 5 seconds.
  - "00 RET" is displayed on the front panel display.
- 3 Repeatedly press [▶] (right) until "06 FTO" is displayed on the front panel display.
- 4 Press [OK].

### The remote control does not work.

- The remote control and main unit are using different codes. Change the code on the remote control.

"Remote Control □" appears on the right side of the screen.

("□" stands for a number.)

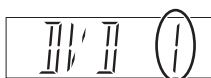

Front panel display

Press and hold [OK] and the indicated number button at the same time for more than 5 seconds. (⇒ 66)

### Startup is slow.

- Startup takes time in the following situations:
  - A disc is inserted.
  - The clock is not set.
  - Immediately after a power failure or the AC mains lead is connected.
  - When the "Quick Start" is not activated. (⇒ 66)



## Displays

### “0:00” is flashing on the front panel display.

- Set the clock. (⇒ 67)

### The clock does not display on the unit when switched to standby.

- The clock does not display when “Front Panel Display” is set to “Automatic”. (⇒ 64)

## TV screen and video

### Screen size is wrong.

- Check the “TV Aspect” or “Aspect for 4:3 Video”. (⇒ 64)
- Adjust the aspect ratio setting on TV.
- Adjust the aspect ratio setting on this unit. (⇒ 71)
- Check “Aspect for Recording” before recording or file conversion. (⇒ 62)

### The black screen appears on the TV.

- This phenomenon may occur, depending on the TV setting, when “Quick Start” is activated. Depending on the TV, this phenomenon may be prevented by reconnecting to a different HDMI input terminal.

### TV reception is not displayed.

- Broadcast signals are not output from this unit’s RF OUT terminal. Select “On” in “RF OUT (Aerial Signal)”. (⇒ 66)

### The screen changes automatically.

- If “Screen Saver” is set to “On”, the screen saver function will be activated when there is no operation for 5 minutes or more. (⇒ 64)

### There is a lot of image lag when playing video.

- Set to “0” all items in the “Noise Reduction”. (⇒ 59)
- Set “Audio Delay”. (⇒ 64)

### The images do not appear on the TV.

### The picture is distorted during play, or video is not played correctly.

- Check the connections. (⇒ 14)
- Check the settings of the connected TV, etc.
- An incorrect resolution is selected in “HDMI Video Format”. (⇒ 65) Reset the setting as follows:
  - 1 While the unit is on, press and hold [OK], the yellow button and the blue button at the same time for more than 5 seconds.
    - “00 RET” is displayed on the front panel display.
  - 2 Repeatedly press [▶] (right) until “04 PRG” is displayed on the front panel display.
  - 3 Press and hold [OK] for at least 3 seconds. Set the item again.
- The unit’s TV System is different from that of the disc. Change the TV System. (⇒ 65, TV System)
- The picture may be distorted or a black screen may appear between scenes recorded with different aspect ratios.
- Set “Deep Colour Output” (⇒ 65) or “Contents Type Flag” (⇒ 65) to “Off”.

### 3D video is not output correctly.

- 3D video may be output correctly by changing the following settings:
  - “3D Type” of “3D Settings” (⇒ 64)
  - “Signal Format” (⇒ 35, 3D settings during playback)
- Check the settings of the connected TV.
- When a non-3D compatible amplifier/receiver is connected between this unit and a TV, 3D video is not output. (⇒ 15)

## Troubleshooting guide

### Sound

#### No sound.

##### Distorted sound.

- Check the connections. (⇒ 14)
- Check the settings of the connected TV, etc.
- Select the audio with "Multi Audio". (⇒ 19, 34)

#### Cannot change audio channel.

- You cannot change the audio channel if "Digital Audio Output" is set to "Bitstream" (⇒ 64)

### Recording, timer recording and copying

#### Cannot record.

##### Cannot copy.

- Some broadcasts are copyright protected.
- You cannot record to the disc by pressing the [REC ●] or timer recording.
- The disc is protected. (⇒ 69)
- **DVD-R** **DVD-RW** **+R** **+RW** Since it will copy to HDD temporarily, copying is not possible if there is insufficient available capacity on the HDD.
- This unit cannot record/copy NTSC signals to discs that already have PAL signal recordings.

#### Timer recording does not work properly.

- When  is displayed on the screen. (⇒ 28)
- Because the actual broadcast time may be different from the time displayed on the TV Guide, we recommend you set the start time earlier and the end time later by some minutes, up to a maximum of 10 minutes.

#### Auto Renewal Recording does not work properly.

- The programme will not be overwritten in the following cases:
  - the programme is protected
  - any programme is being played back or copied
  - a screen such as Video Menu is displayed
 Instead, the programme will be saved as a separate programme and that will be overwritten.

#### A part or whole of a recorded title has been lost.

If there is a power failure or the AC mains lead is disconnected from the household mains socket while recording or editing, the title may be lost or the HDD may become unusable. We cannot offer any guarantee regarding lost programmes.

#### An unusually loud sound is coming from the rotating disc.

- If you want copy to perform more quietly, select "Normal ( Silent )" in "Disc Speed for High Speed Copy". (⇒ 62)

#### The time recorded on the disc and the available time shown do not add up.

- **DVD-R** **+R** If you record or edit many times, the remaining capacity is reduced and then recording or editing may be disabled.
- Available disc space display may be different from actual.

### Play

#### Cannot play back.

- The disc is dirty. (⇒ 10)
- The disc is scratched or marked.
- The disc may not be able to play back if it was not finalised or a Top Menu was not created on the equipment used for recording.
- Refer to "Screen icons". (⇒ 30)

#### Audio and video momentarily pause.

- DVD-R DL and +R DL discs have two writable layers on one side. Video and audio may momentarily cut out when the unit is switching layers.

### You have forgotten your rating PIN number for parental control.

- The PIN number for parental control and the rating level return to the factory preset.

The default PIN number is "0000".

- 1 While the unit is on, press and hold [OK], the yellow button and the blue button at the same time for more than 5 seconds.
  - "00 RET" is displayed on the front panel display.
- 2 Repeatedly press [▶] (right) until "03 VL" is displayed on the front panel display.
- 3 Press [OK].
  - "INIT" is displayed on the front panel display.

### Image for the Quick View is not smooth.

- Image may not be played back smoothly in case of high definition titles.

### Cannot play the disc on other players.

- Refer to "Play on other players". (⇒ 10)

### Edit

#### Cannot edit.

- You may not be able to edit on the HDD if there is no available space. Delete any unwanted titles to create empty space. (⇒ 36)

### Photo

#### Photos do not play back normally.

- The images that were edited on the PC, such as Progressive JPEG, etc., may not play back. (⇒ 8)

### USB

#### This unit does not recognize the USB device correctly.

- If inserted during playback the USB device may not be recognized by this unit. Disconnect and reconnect the USB device. If it still does not recognize the connection, switch the unit to standby mode and turn it on again.
- USB devices connected using a USB extension cable other than a dedicated one or a USB hub may not be recognized by this unit.

### TV Guide

#### The TV Guide information is not displayed properly.

- Set the clock correctly. (⇒ 67, Clock)
- There was a programme change, or TV Guide information from a broadcast station was possibly not correctly transmitted.
- If signal quality is bad, the TV Guide system may not be able to receive any data.
- It may take time until the TV Guide screen is displayed correctly. Wait for about a day.

### Broadcast

#### Picture regularly breaks up on some channels.

- Adjust the reception with "Manual Tuning". (⇒ 61)

### Reset

#### To return all the settings to the factory preset

Perform "Shipping Condition" or "Default Settings". (⇒ 67)

## Troubleshooting guide

### Messages on the front panel display

The following messages or service numbers appear on the front panel display when something unusual is detected.

#### CONV

Selected titles in the USB HDD are being converted.

Do not disconnect the USB HDD from this unit.

#### DVD □

("□" stands for a number.)

The remote control and main unit are using different codes. Change the code on the remote control. (⇒ 72)

#### GUIDE

TV Guide data is being downloaded.

#### HARD ERR

If there is no change after switching the unit to standby mode and turning it on, consult the dealer.

#### NoERAS

You cannot delete items on this disc.  
The disc may be damaged.

#### NoREAD

- The disc is dirty. (⇒ 10) The unit cannot record, play, or edit.
- The lens cleaner has finished cleaning.  
Press [**▲** OPEN/CLOSE] on the main unit to eject the disc.

#### NoWRIT

You cannot write to this disc.  
The disc may be damaged. Use a new disc.

#### PLEASE WAIT

- Displayed when the unit is started and is switched to standby mode.
- There was a power failure or the AC plug was disconnected while the unit was on. The unit is carrying out its recovery process. Wait until the message disappears.

#### PROG FULL

There are already 32 timer programmes. Delete unnecessary timer programmes. (⇒ 28)

#### REMOVE

The USB device is drawing too much power.  
Remove the USB device.

#### START

Update of the software (firmware) is started.  
You cannot operate the unit until the update is complete. (⇒ 68)

#### SW-DL

Software (firmware) is downloading.  
Download will stop when the unit is turned on, or the timer recording starts. (⇒ 68)

#### UNSUPPORT

The media is not supported.

**UPD** □/□

("□" stands for a number.)

The software (firmware) is being updated.  
You cannot operate the unit until the update is complete. (⇒ 68)

**U59**

The unit is hot.  
The unit switches to standby for safety reasons.  
Wait for about 30 minutes until the message disappears.  
Install or place this unit with good ventilation.

**U61**

(When a disc is not inserted) A malfunction has occurred. The unit is trying to restore to the normal operation. Once the message disappears you can use the unit again.  
If it remains displayed, consult the dealer.

**U76**

HDMI cannot be output because it is connected to a model that does not support copyright protection.

**U77**

Due to the current disc not having authorised copyright information, video output is not performed.

**U88**

(When a disc is inserted) There was something unusual detected with the disc or the unit. The unit is trying to restore to the normal operation. Once the message disappears you can use the unit again.  
If it remains displayed, consult the dealer.

**U99**

The unit fails to operate properly. Press [⏻/|] on the main unit to switch the unit to standby mode. Now press [⏻/|] on the main unit again to turn the unit on.

**X HOLD**

The HOLD function is activated. (⇒ 70)

# Specifications

Specifications are subject to change without notice.

## ■ General

Dimensions: 430 mm (W)  
59 mm (H)  
(including the projecting parts)  
210 mm (D)

Mass: Approx. 2.0 kg  
Power supply: AC 220 V to 240 V, 50 Hz  
Power consumption: Approx. 20 W

Power consumption in Standby mode :  
“Quick Start” is not activated and “RF OUT  
( Aerial Signal )” is set to “Off”

Approx. 0.2 W  
Operating temperature: 5 °C to 40 °C  
Operating humidity range: 10 % to 80 % RH  
(no condensation)

## ■ TV system

Tuner System: DVB-T/T2  
Country: UK  
Channel Coverage: UHF 21~68

## ■ HDMI terminal

HDMI out (19 pin type A): 1 pc.

## ■ Internal HDD capacity

500 GB

## ■ Other terminals

USB Port (Type A): USB2.0  
1 pc.  
LAN (Ethernet) Port: 1 pc.  
10BASE-T/100BASE-TX

## ■ LASER specification

Class 1 LASER Product

Wave length: 661 nm (DVDs)  
783 nm (CDs)

Laser power:

No hazardous radiation is emitted with  
the safety protection

## Recording modes and approximate recording times

Depending on the content being recorded, the recording time may become shorter than indicated.

## ■ DR mode

Recording Mode	HDD (500 GB)
DR (HD quality)	129 hours
DR (SD quality)	258 hours

### • Recording time of DR mode may vary depending on the bit rate of broadcasting:

- High Definition (HD) quality: estimated bit rate is 8 Mbps
- Standard Definition (SD) quality: estimated bit rate is 4 Mbps

### • Regarding recording time remaining:

Remaining time in the DR mode is calculated with a bit rate of 8 Mbps. But the bit rate differs depending on the broadcast, so the displayed remaining time might be different from the actual remaining time.

## ■ HG, HX, HE, HL, HM modes

Recording Mode	HDD (500 GB)
HG	78 hours
HX	117 hours
HE	176 hours
HL	235 hours
HM	341 hours

## ■ XP, SP, LP, EP modes

Recording Mode	HDD (500 GB)
XP	107 hours
SP	215 hours
LP	430 hours
EP	860 hours

Recording Mode	DVD-RAM		DVD-R,	DVD-R
	Single-sided (4.7 GB)	Double-sided (9.4 GB)	+R, +RW (4.7 GB)	DL, +R DL (8.5 GB)
XP	1 hour	2 hours	1 hour	1 hour 45 min.
SP	2 hours	4 hours	2 hours	3 hours 35 min.
LP	4 hours	8 hours	4 hours	7 hours 10 min.
EP	8 hours	16 hours	8 hours	14 hours 20 min.

### • Regarding recording time remaining:

This unit records using a VBR (Variable bit rate) data compression system to vary recorded data segments to match video data segments which may cause differences in the displayed amount of time and space remaining for recording.

### Audio information

The audio output differs depending on the setting on this unit. (⇒ 64, Digital Audio Output)

- The number of channels listed is the maximum possible number of output channels when connected to amplifier/receiver compatible with the respective audio format.

Terminal	Digital Audio Output	
	Bitstream	PCM*
HDMI AV OUT	Output using original audio	5.1ch PCM

\* The maximum possible number of Dolby® sound is 2ch PCM.

## Language code list

Abkhazian:	6566	Lingala:	7678
Afar:	6565	Lithuanian:	7684
Afrikaans:	6570	Macedonian:	7775
Albanian:	8381	Malagasy:	7771
Amharic:	6577	Malay:	7783
Arabic:	6582	Malayalam:	7776
Armenian:	7289	Maltese:	7784
Assamese:	6583	Maori:	7773
Aymara:	6589	Marathi:	7782
Azerbaijani:	6590	Moldavian:	7779
Bashkir:	6665	Mongolian:	7778
Basque:	6985	Nauru:	7865
Bengali, Bangla:	6678	Nepali:	7869
Bhutani:	6890	Norwegian:	7879
Bihari:	6672	Oriya:	7982
Breton:	6682	Pashoto, Pushto:	8083
Bulgarian:	6671	Persian:	7065
Burmese:	7789	Polish:	8076
Byelorussian:	6669	Portuguese:	8084
Cambodian:	7577	Punjabi:	8065
Catalan:	6765	Quechua:	8185
Chinese:	9072	Rhaeto-Romance:	8277
Corsican:	6779	Romanian:	8279
Croatian:	7282	Russian:	8285
Czech:	6783	Samoan:	8377
Danish:	6865	Sanskrit:	8365
Dutch:	7876	Scots Gaelic:	7168
English:	6978	Serbian:	8382
Esperanto:	6979	Serbo-Croatian:	8372
Estonian:	6984	Shona:	8378
Faroese:	7079	Sindhi:	8368
Fiji:	7074	Singhalese:	8373
Finnish:	7073	Slovak:	8375
French:	7082	Slovenian:	8376
Frisian:	7089	Somali:	8379
Galician:	7176	Spanish:	6983
Georgian:	7565	Sundanese:	8385
German:	6869	Swahili:	8387
Greek:	6976	Swedish:	8386
Greenlandic:	7576	Tagalog:	8476
Guarani:	7178	Tajik:	8471
Gujarati:	7185	Tamil:	8465
Hausa:	7265	Tatar:	8484
Hebrew:	7387	Telugu:	8469
Hindi:	7273	Thai:	8472
Hungarian:	7285	Tibetan:	6679
Icelandic:	7383	Tigrinya:	8473
Indonesian:	7378	Tonga:	8479
Interlingua:	7365	Turkish:	8482
Irish:	7165	Turkmen:	8475
Italian:	7384	Twí:	8487
Japanese:	7465	Ukrainian:	8575
Javanese:	7487	Urdu:	8582
Kannada:	7578	Uzbek:	8590
Kashmiri:	7583	Vietnamese:	8673
Kazakh:	7575	Volapük:	8679
Kirghiz:	7589	Welsh:	6789
Korean:	7579	Wolof:	8779
Kurdish:	7585	Xhosa:	8872
Laotian:	7679	Yiddish:	7473
Latin:	7665	Yoruba:	8979
Latvian, Lettish:	7686	Zulu:	9085

# Reference

## Disposal of Old Equipment and Batteries

Only for European Union and countries with recycling systems



These symbols on the products, packaging, and/or accompanying documents mean that used electrical and electronic products and batteries must not be mixed with general household waste.

For proper treatment, recovery and recycling of old products and used batteries, please take them to applicable collection points in accordance with your national legislation. By disposing of them correctly, you will help to save valuable resources and prevent any potential negative effects on human health and the environment.

For more information about collection and recycling, please contact your local municipality.

Penalties may be applicable for incorrect disposal of this waste, in accordance with national legislation.

### Note for the battery symbol (bottom symbol):

This symbol might be used in combination with a chemical symbol. In this case it complies with the requirement set by the Directive for the chemical involved.

<b>DANGER</b> – VISIBLE AND INVISIBLE LASER RADIATION WHEN OPEN, AVOID DIRECT EXPOSURE TO BEAM. FDA21 CFR/CLASS IIIb	
<b>CAUTION</b> – CLASS 3B VISIBLE AND INVISIBLE LASER RADIATION WHEN OPEN, AVOID EXPOSURE TO THE BEAM. IEC60825-1/CLASS 3B	
<b>ATTENTION</b> – RAYONNEMENT LASER VISIBLE ET INVISIBLE, CLASSE 3B, EN CAS D'OUVERTURE, ÉVITER UNE EXPOSITION AU FAISCEAU.	
<b>FORSIGTIG</b> – SYNLIG OG USYNLIG LASERSTRÅLING KLASSE 3B, NÅR LÅGET ER ÅBENT, UNDGÅ AT BLIVE UDSAT FOR STRÅLEN.	
<b>VARO</b> – AVATTAESSA OLET ALTTIINA LUOKAN 3B NÄKYVÄÄ JA NÄKYMÄTÖNTÄ LASERSÄTEILYÄ, VARO ALTISTUMISTA SÄTEELLE.	
<b>VARNING</b> – KLASS 3B SYNLIG OCH OSYNLIG LASERSTRÅLNING NÄR DENNA DEL ÄR ÖPPNAD, UNDVIK EXPONERING FÖR STRÅLEN.	
<b>VORSICHT</b> – SICHTBARE UND UNSICHTBARE LASERSTRAHLUNG KLASSE 3B, WENN ABDECKUNG GEÖFFNET, NICHT DEM STRAHL AUSSETZEN.	
<b>注意</b> – 打开时有可见及不可见激光辐射。避免光束照射。	
<b>注意</b> – ここを開くとクラス3Bの可視及び不可視レーザー放射が出る ビームの目又は皮膚への被曝は危険! 見たり触れたりしないこと	VOL2Q40

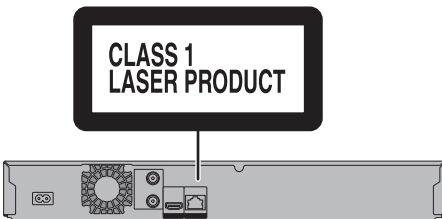

(Inside of product)



(Back of product)



# Licenses

<p>"AVCHD", "AVCHD 3D", "AVCHD Progressive" and "AVCHD 3D/Progressive" are trademarks of Panasonic Corporation and Sony Corporation.</p>	
<p>DVB and the DVB logos are trademarks of the DVB Project.</p>	
<p>MPEG Layer-3 audio coding technology licensed from Fraunhofer IIS and Thomson.</p>	
<p>Manufactured under license from Dolby Laboratories. Dolby and the double-D symbol are trademarks of Dolby Laboratories.</p>	
<p>For DTS patents, see <a href="http://patents.dts.com">http://patents.dts.com</a>. Manufactured under license from DTS Licensing Limited. DTS, the Symbol, &amp; DTS and the Symbol together are registered trademarks, and DTS Digital Surround is a trademark of DTS, Inc. © DTS, Inc. All Rights Reserved.</p>	
<p>"DVD Logo" is a trademark of DVD Format/Logo Licensing Corporation.</p>	
<p>This product is licensed under the AVC patent portfolio license for the personal use of a consumer or other uses in which it does not receive remuneration to (i) encode video in compliance with the AVC Standard ("AVC Video") and/or (ii) decode AVC Video that was encoded by a consumer engaged in a personal activity and/or was obtained from a video provider licensed to provide AVC Video. No license is granted or shall be implied for any other use. Additional information may be obtained from MPEG LA, L.L.C. See <a href="http://www.mpegla.com">http://www.mpegla.com</a></p>	
<p>HDMI, the HDMI Logo, and High-Definition Multimedia Interface are trademarks or registered trademarks of HDMI Licensing LLC in the United States and other countries.</p>	
<p>This product incorporates the following software: (1) the software developed independently by or for Panasonic Corporation, (2) the software owned by third party and licensed to Panasonic Corporation, (3) the software licensed under the GNU General Public License, Version 2.0 (GPL V2.0), (4) the software licensed under the GNU LESSER General Public License, Version 2.1 (LGPL V2.1), and/or (5) open source software other than the software licensed under the GPL V2.0 and/or LGPL V2.1.</p> <p>The software categorized as (3) - (5) are distributed in the hope that it will be useful, but WITHOUT ANY WARRANTY, without even the implied warranty of MERCHANTABILITY or FITNESS FOR A PARTICULAR PURPOSE. Please refer to the detailed terms and conditions thereof shown in the Basic Settings menu.</p> <p>At least three (3) years from delivery of this product, Panasonic will give to any third party who contacts us at the contact information provided below, for a charge no more than our cost of physically performing source code distribution, a complete machine-readable copy of the corresponding source code covered under GPL V2.0, LGPL V2.1 or the other licenses with the obligation to do so, as well as the respective copyright notice thereof. Contact Information: <a href="mailto:oss-cd-request@gg.jp.panasonic.com">oss-cd-request@gg.jp.panasonic.com</a></p> <p>The source code and the copyright notice are also available for free in our website below. <a href="http://panasonic.net/avc/oss/">http://panasonic.net/avc/oss/</a></p>	
<p>Vorbis, FLAC</p>	
<p>The software licenses are displayed when "Software Licence" in the Basic Settings menu is selected. (⇒ 67)</p>	
<p>The Freeview service and channels are subject to coverage and may be changed from time to time. Aerial upgrade and/or receiver may be required. Visit <a href="http://freeview.co.uk/availability">freeview.co.uk/availability</a>.</p> <p>The FREEVIEW words and logos are trade marks of DTV Services LTD. © DTV Services Ltd Selected products only.</p>	

# Index

- A**
- Aspect** ..... 64, 71
  - Audio** ..... 19, 34, 79
  - Audio Description** ..... 20, 34, 62
  - Auto Setup** ..... 16, 61
  - AVCHD** ..... 29, 32, 47, 54
- B**
- Basic Settings** ..... 60
- C**
- Channel information** ..... 19
  - Channel List** ..... 20, 61
  - Chapter** ..... 31, 34, 39, 62
  - Child Lock** ..... 61, 62
    - DVD-Video Parental Control ..... 62
    - HOLD function ..... 70
  - Clock** ..... 67
  - Connection**
    - Network ..... 15
  - Copy** ..... 40
    - AVCHD ..... 54
- D**
- Delete**
    - Music ..... 53
    - Photo ..... 50
    - Video ..... 36
  - Disc**
    - Finalise ..... 70
    - Format ..... 69
    - Media information ..... 6
    - Protection ..... 69
  - DVD-Video** ..... 32
- E**
- Easy setting** ..... 16
  - Entering text** ..... 71
- F**
- Favourites** ..... 60
  - Finalise** ..... 70
  - Format**
    - Disc ..... 69
    - HDD ..... 63
    - USB HDD ..... 63
  - Freeview** ..... 25
  - FUNCTION MENU** ..... 18
- H**
- HDD**
    - Format ..... 63
    - Media information ..... 6
- L**
- Language code list** ..... 79
- M**
- Manual Tuning** ..... 61
  - Menu Screen** ..... 32
  - Music** ..... 52
- N**
- Network**
    - Connection ..... 15
    - Easy Network Setting ..... 17, 65

<b>P</b>	
<b>PAUSE LIVE TV</b> .....	21
<b>Photo</b> .....	48
<b>PIN</b> .....	19, 67
<b>Playback menu</b> .....	58
<b>Protection</b>	
Disc .....	69
Photo .....	50
Video .....	37
<b>Q</b>	
<b>Quick Start</b> .....	66
<b>R</b>	
<b>Recording</b> .....	22
Recording mode .....	78
Timer recording .....	24
<b>Recording mode</b> .....	78
<b>Recording time</b> .....	78
<b>Remote control</b> .....	12
HOLD function .....	70
Remote control code .....	66
TV operation .....	16
<b>Reset</b> .....	67, 75
<b>REWIND LIVE TV</b> .....	21, 62
<b>S</b>	
<b>Setting</b>	
Auto Setup .....	16, 61
Easy setting .....	16
<b>Slideshow</b> .....	49
<b>Software (Firmware) Update</b> .....	68
<b>T</b>	
<b>Timer recording</b> .....	24
<b>Top Menu</b> .....	70
Create Top Menu .....	70
<b>Troubleshooting guide</b> .....	72
Messages .....	76
<b>Tuning</b>	
Channel List .....	61
Channel Sorting by Region .....	61
Child Lock .....	61
Manual Tuning .....	61
Signal condition .....	61
<b>TV Guide</b>	
Operation .....	20
Timer recording .....	24
<b>TV System</b> .....	65
<b>U</b>	
<b>USB HDD</b>	
Cancellation of all USB HDD Registrations .....	63
Disconnection .....	56, 63
Format .....	63
Media information .....	6, 9
Registration .....	56, 63
<b>USB memories</b>	
Media information .....	6, 9
<b>V</b>	
<b>Video</b>	
AVCHD .....	29, 32
Copy .....	40
Delete .....	36
MKV .....	32
Playback .....	29, 32
Protection .....	37
Recording .....	22
Video Menu .....	29
Xvid .....	8
3D .....	35
<b>VIERA Link</b> .....	57, 65
<b>X</b>	
<b>Xvid</b> .....	8
<b>3D</b> .....	35

## Sales and Support Information

### Customer Communications Centre

- For customers within the UK: 0344 844 3899
- For customers within Ireland: 01 289 8333
- Monday - Friday 9:00 am - 5:00 pm (Excluding public holidays).
- For further support on your product, please visit our website: [www.panasonic.co.uk](http://www.panasonic.co.uk)

### Direct Sales at Panasonic UK

- Order accessory and consumable items for your product with ease and confidence by phoning our Customer Communications Centre Monday - Friday 9:00 am - 5:00 pm (Excluding public holidays).
- Or go on line through our Internet Accessory ordering application at [www.pas-europe.com](http://www.pas-europe.com).
- Most major credit and debit cards accepted.
- All enquiries transactions and distribution facilities are provided directly by Panasonic UK.
- It couldn't be simpler!
- Also available through our Internet is direct shopping for a wide range of finished products. Take a browse on our website for further details.

To get the most up to date service from Freeview it is important for Freeview customers to retune from time to time.

### **How do I re-tune my Freeview Box?**

The below instructions are a quick reference. If you have any problems, check your instruction manual or ask a friend or family member to show you how. Alternatively, go to your local electrical retailer, contact your manufacturer or visit [freeview.co.uk/retune](http://freeview.co.uk/retune)

Re-tuning only takes a few minutes, just follow the steps below:

- 1 Press [FUNCTION MENU].
- 2 Select "Basic Settings" in "Setup", then press [OK].
- 3 Select "Auto Setup" in "Tuning", then press [OK].
- 4 Select "Yes", then press [OK].

Please note: most digital TV recorders will keep your original recording safer running a re-tune but you will need to reset any future recordings.

For detailed information on re-tuning your receiver please refer to page 61 of this instruction book

Manufactured by: Panasonic Corporation  
Kadoma, Osaka, Japan  
Importer for Europe: Panasonic Marketing Europe GmbH  
Panasonic Testing Centre  
Winsbergring 15, 22525 Hamburg, Germany



**Panasonic Corporation**  
Web Site: <http://www.panasonic.com>

En

SQT0994