

▶ BCK556220M
BCS556020M

EN User Manual
Oven

USER MANUAL



AEG

CONTENTS

1. SAFETY INFORMATION.....	2
2. SAFETY INSTRUCTIONS.....	4
3. PRODUCT DESCRIPTION.....	7
4. CONTROL PANEL.....	8
5. BEFORE FIRST USE.....	8
6. DAILY USE.....	9
7. CLOCK FUNCTIONS.....	11
8. USING THE ACCESSORIES.....	14
9. ADDITIONAL FUNCTIONS.....	18
10. HINTS AND TIPS.....	19
11. CARE AND CLEANING.....	37
12. TROUBLESHOOTING.....	41
13. ENERGY EFFICIENCY.....	44

FOR PERFECT RESULTS

Thank you for choosing this AEG product. We have created it to give you impeccable performance for many years, with innovative technologies that help make life simpler – features you might not find on ordinary appliances. Please spend a few minutes reading to get the very best from it.

Visit our website for:



Get usage advice, brochures, trouble shooter, service and repair information:
www.aeg.com/support



Register your product for better service:
www.registeraeg.com



Buy Accessories, Consumables and Original spare parts for your appliance:
www.aeg.com/shop

CUSTOMER CARE AND SERVICE

Always use original spare parts.

When contacting our Authorised Service Centre, ensure that you have the following data available: Model, PNC, Serial Number.

The information can be found on the rating plate.

 Warning / Caution-Safety information

 General information and tips

 Environmental information

Subject to change without notice.

1. SAFETY INFORMATION

Before the installation and use of the appliance, carefully read the supplied instructions. The

manufacturer is not responsible for any injuries or damage that are the result of incorrect installation or usage. Always keep the instructions in a safe and accessible location for future reference.

1.1 Children and vulnerable people safety

- This appliance can be used by children aged from 8 years and above and persons with reduced physical, sensory or mental capabilities or lack of experience and knowledge if they have been given supervision or instruction concerning the use of the appliance in a safe way and understand the hazards involved.
- Children between 3 and 8 years of age and persons with very extensive and complex disabilities shall be kept away from the appliance unless continuously supervised.
- Children of less than 3 years of age should be kept away from the appliance unless continuously supervised.
- Do not let children play with the appliance.
- Keep all packaging away from children and dispose of it appropriately.
- Keep children and pets away from the appliance when it operates or when it cools down. Accessible parts become hot during use.
- If the appliance has a child safety device, it should be activated.
- Children shall not carry out cleaning and user maintenance of the appliance without supervision.

1.2 General Safety

- Only a qualified person must install this appliance and replace the cable.
- **WARNING:** The appliance and its accessible parts become hot during use. Care should be taken to avoid touching heating elements.
- Always use oven gloves to remove or put in accessories or ovenware.

- Before carrying out any maintenance, disconnect the appliance from the power supply.
- **WARNING:** Ensure that the appliance is switched off before replacing the lamp to avoid the possibility of electric shock.
- Do not use the appliance before installing it in the built-in structure.
- Do not use a steam cleaner to clean the appliance.
- Do not use harsh abrasive cleaners or sharp metal scrapers to clean the glass door since they can scratch the surface, which may result in shattering of the glass.
- If the mains power supply cable is damaged, it must be replaced by the manufacturer, its Authorised Service Centre or similarly qualified persons to avoid an electrical hazard.
- To remove the shelf supports first pull the front of the shelf support and then the rear end away from the side walls. Install the shelf supports in the opposite sequence.
- The means for disconnection must be incorporated in the fixed wiring in accordance with the wiring rules.
- Use only the food sensor (core temperature sensor) recommended for this appliance.

2. SAFETY INSTRUCTIONS

2.1 Installation



WARNING!

Only a qualified person must install this appliance.

- Remove all the packaging.
- Do not install or use a damaged appliance.
- Follow the installation instructions supplied with the appliance.
- Always take care when moving the appliance as it is heavy. Always use safety gloves and enclosed footwear.
- Do not pull the appliance by the handle.
- Install the appliance in a safe and suitable place that meets installation requirements.

- Keep the minimum distance from other appliances and units.
- Before mounting the appliance, check if the oven door opens without restraint.
- The appliance is equipped with an electric cooling system. It must be operated with the electric power supply.
- The built-in unit must meet the stability requirements of DIN 68930.

Cabinet minimum height (Cabinet under the worktop minimum height)	600 (600) mm
---	--------------

Cabinet width	550 mm
Cabinet depth	605 (580) mm
Height of the front of the appliance	594 mm
Height of the back of the appliance	576 mm
Width of the front of the appliance	549 mm
Width of the back of the appliance	548 mm
Depth of the appliance	567 mm
Built in depth of the appliance	546 mm
Depth with open door	1017 mm
Ventilation opening minimum size. Opening placed on the bottom rear side	550 x 20 mm
Mounting screws	4 x 12 mm

2.2 Electrical connection



WARNING!

Risk of fire and electric shock.

- All electrical connections should be made by a qualified electrician.
- The appliance must be earthed.
- Make sure that the parameters on the rating plate are compatible with the electrical ratings of the mains power supply.
- Always use a correctly installed shockproof socket.
- Do not use multi-plug adapters and extension cables.
- Make sure not to cause damage to the mains plug and to the mains cable. Should the mains cable need to be replaced, this must be carried out by our Authorised Service Centre.
- Do not let mains cables touch or come near the appliance door or the

niche below the appliance, especially when it operates or the door is hot.

- The shock protection of live and insulated parts must be fastened in such a way that it cannot be removed without tools.
- Connect the mains plug to the mains socket only at the end of the installation. Make sure that there is access to the mains plug after the installation.
- If the mains socket is loose, do not connect the mains plug.
- Do not pull the mains cable to disconnect the appliance. Always pull the mains plug.
- Use only correct isolation devices: line protecting cut-outs, fuses (screw type fuses removed from the holder), earth leakage trips and contactors.
- The electrical installation must have an isolation device which lets you disconnect the appliance from the mains at all poles. The isolation device must have a contact opening width of minimum 3 mm.
- This appliance is supplied without a main plug and a main cable.

2.3 Use



WARNING!

Risk of injury, burns and electric shock or explosion.

- This appliance is for household use only.
- Do not change the specification of this appliance.
- Make sure that the ventilation openings are not blocked.
- Do not let the appliance stay unattended during operation.
- Deactivate the appliance after each use.
- Be careful when you open the appliance door while the appliance is in operation. Hot air can release.
- Do not operate the appliance with wet hands or when it has contact with water.
- Do not apply pressure on the open door.
- Do not use the appliance as a work surface or as a storage surface.

- Open the appliance door carefully. The use of ingredients with alcohol can cause a mixture of alcohol and air.
- Do not let sparks or open flames to come in contact with the appliance when you open the door.
- Do not put flammable products or items that are wet with flammable products in, near or on the appliance.

**WARNING!**

Risk of damage to the appliance.

- To prevent damage or discoloration to the enamel:
 - do not put ovenware or other objects in the appliance directly on the bottom.
 - do not put aluminium foil directly on the bottom of cavity of the appliance.
 - do not put water directly into the hot appliance.
 - do not keep moist dishes and food in the appliance after you finish the cooking.
 - be careful when you remove or install the accessories.
- Discoloration of the enamel or stainless steel has no effect on the performance of the appliance.
- Use a deep pan for moist cakes. Fruit juices cause stains that can be permanent.
- This appliance is for cooking purposes only. It must not be used for other purposes, for example room heating.
- Always cook with the oven door closed.
- If the appliance is installed behind a furniture panel (e.g. a door) make sure the door is never closed when the appliance operates. Heat and moisture can build up behind a closed furniture panel and cause subsequent damage to the appliance, the housing unit or the floor. Do not close the furniture panel until the appliance has cooled down completely after use.

2.4 Care and cleaning

**WARNING!**

Risk of injury, fire, or damage to the appliance.

- Before maintenance, deactivate the appliance and disconnect the mains plug from the mains socket.
- Make sure the appliance is cold. There is the risk that the glass panels can break.
- Replace immediately the door glass panels when they are damaged. Contact the Authorised Service Centre.
- Be careful when you remove the door from the appliance. The door is heavy!
- Clean regularly the appliance to prevent the deterioration of the surface material.
- Clean the appliance with a moist soft cloth. Use only neutral detergents. Do not use abrasive products, abrasive cleaning pads, solvents or metal objects.
- If you use an oven spray, follow the safety instructions on its packaging.
- Do not clean the catalytic enamel with detergents.

2.5 Internal lighting

**WARNING!**

Risk of electric shock.

- The type of light bulb or halogen lamp used for this appliance is for household appliances only. Do not use it for house lighting.
- Before replacing the lamp, disconnect the appliance from the power supply.
- Use only lamps with the same specifications.

2.6 Service

- To repair the appliance contact the Authorised Service Centre.
- Use original spare parts only.

2.7 Disposal

**WARNING!**

Risk of injury or suffocation.

- Disconnect the appliance from the mains supply.
- Cut off the mains electrical cable close to the appliance and dispose of it.

- Remove the door catch to prevent children or pets from becoming trapped in the appliance.

3. PRODUCT DESCRIPTION

3.1 General overview

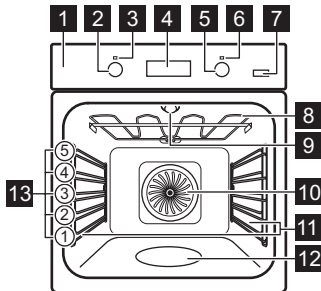

- 1** Control panel
- 2** Knob for the heating functions
- 3** Power lamp / symbol
- 4** Display
- 5** Control knob (for the temperature)
- 6** Temperature indicator / symbol
- 7** Plus Steam
- 8** Heating element
- 9** Lamp
- 10** Fan
- 11** Shelf support, removable
- 12** Cavity embossment
- 13** Shelf positions

3.2 Accessories

Wire shelf

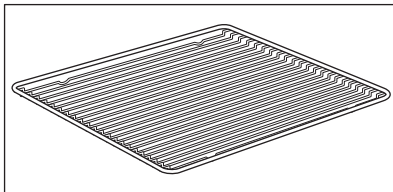

For cookware, cake tins, roasts.

Grill- / Roasting pan

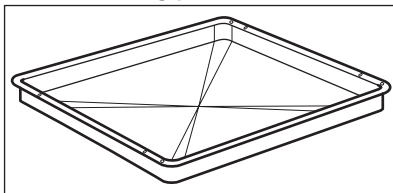

To bake and roast or as a pan to collect fat.

Trivet

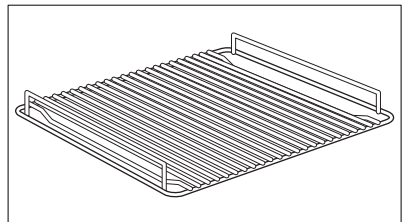

For roasting and grilling.



Use the trivet only with the Grill- / Roasting pan.

Food Sensor

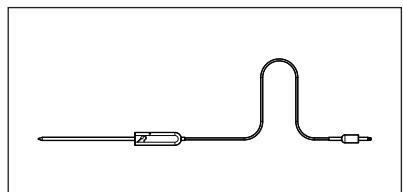





To measure the temperature inside food.

4. CONTROL PANEL

4.1 Retractable knobs

To use the appliance press the knob. The knob comes out.

4.2 Buttons

Sensor field / Button	Description
	To set the MINUTE MINDER. Hold it for more than 3 seconds to turn on or turn off the oven lamp.
	To set a clock function.
	To check the oven temperature or the temperature of the core temperature sensor (if applicable). Use only while a heating function operates.
	To turn on the True Fan Cooking PLUS function.

4.3 Display

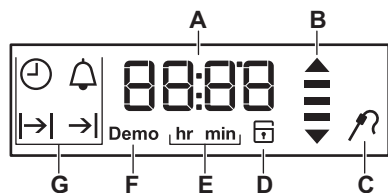

- A. Timer / Temperature
- B. Heat-up and residual heat indicator
- C. Food Sensor (selected models only)
- D. Door lock (selected models only)
- E. Hours / minutes
- F. Demo Mode
- G. Clock functions



5. BEFORE FIRST USE



WARNING!
Refer to Safety chapters.

Set the time before you use the oven.

5.1 Initial Cleaning

		
Step 1	Step 2	Step 3
Remove all accessories and removable shelf supports from the oven.	Clean the oven and the accessories with a soft cloth, warm water and a mild detergent.	Place the accessories and the removable shelf supports in the oven.

5.2 Initial preheating



Preheat the empty oven before the first use.

Step 1 Remove all accessories and removable shelf supports from the oven.

Step 2 Set the maximum temperature for the function: .
Let the oven operate for 1 h.

Step 3 Set the maximum temperature for the function: .
Let the oven operate for 15 min.

The oven can emit an odour and smoke during preheating. Make sure that the room is ventilated.

6. DAILY USE



WARNING!
Refer to Safety chapters.

6.1 How to set: Heating function

Step 1 Turn the knob for the heating functions to select a heating function.

Step 2 Turn the control knob to select the temperature.
The lamp turns on when the oven operates.

Step 3 Turn the knob for the heating functions to the off position to turn off the oven.

6.2 Setting the function: True Fan Cooking PLUS



WARNING!
Risk of burns and damage to the appliance.

Step 1 Make sure that the oven is cold.

Step 2 Fill the cavity embossment with tap water.

The maximum capacity of the cavity embossment is 250 ml. Do not refill the cavity embossment during cooking or when the oven is hot.

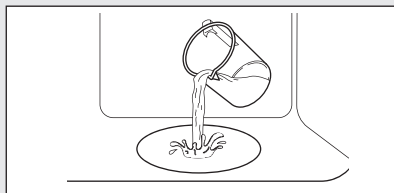

Step 3 Set the function: .
Press: . The indicator turns on. It works only with the function: True Fan Cooking PLUS.

Step 4	Turn the control knob for the temperature to set temperature.
Step 5	Preheat the empty oven for 10 min to create humidity.
Step 6	Put food in the oven. Refer to "Hints and tips" chapter. Do not open the oven door during cooking.
Step 7	Turn the knob for the heating functions to the off position to turn off the oven.  - press to turn off the oven. The indicator turns off.
Step 8	After the function ends, carefully open the door. Released humidity can cause burns.
Step 9	Make sure that the oven is cold. Remove the remaining water from the cavity embossment.

6.3 Fast Heat Up

The fast heat up decreases the heat up time.

 Do not put food in the oven when the Fast heat up operates.

1. Turn the knob for the oven functions to set the fast heat up.
2. Turn the knob for the temperature to set the temperature.



The signal sounds when the oven is at the set temperature.





3. Set an oven function.



6.4 Heat-up indicator

When the oven function operates, the bars in the display  appear one by one when the temperature in the oven increases, and disappear when it decreases.

6.5 Heating functions

Oven function	Application
 Off position	The oven is off.
 Fast Heat Up	To decrease the heat-up time.

Oven function	Application
 True Fan Cooking / True Fan Cooking PLUS	To bake on up to three shelf positions at the same time and to dry food. Set the temperature 20 - 40 °C lower than for Conventional Cooking. To add humidity during the cooking. To get the right colour and crispy crust during baking. To give more juiciness during reheating.
 Pizza Function	To bake pizza. To make intensive browning and a crispy bottom.
 Conventional Cooking	To bake and roast food on one shelf position.
 Bottom Heat	To bake cakes with crispy bottom and to preserve food.
 Defrost	To defrost food (vegetables and fruit). The defrosting time depends on the amount and size of the frozen food.

Oven function	Application
 Moist Fan Baking	This function is designed to save energy during cooking. When you use this function, the temperature in the cavity may differ from the set temperature. The residual heat is used. The heating power may be reduced. For more information refer to "Daily Use" chapter, Notes on: Moist Fan Baking.
 Grill	To grill thin pieces of food and to toast bread.
 Turbo Grilling	To roast large meat joints or poultry with bones on one shelf position. To make gratins and to brown.

Oven function	Application
 Catalysis	To help the self-cleaning catalytic oven layer.



The lamp may turn off automatically at a temperature below 60 °C during some oven functions.

6.6 Notes on: Moist Fan Baking

This function was used to comply with the energy efficiency class and ecodesign requirements according to EU 65/2014 and EU 66/2014. Tests according to EN 60350-1.

The oven door should be closed during cooking so that the function is not interrupted and the oven operates with the highest energy efficiency possible.



When you use this function the lamp automatically turns off after 30 sec.





For the cooking instructions refer to "Hints and tips" chapter, Moist Fan Baking. For general energy saving recommendations refer to "Energy Efficiency" chapter, Energy Saving.

7. CLOCK FUNCTIONS





7.1 Clock functions table

Clock function	Application
 Time of Day	To show or change the time of day. You can change the time of day only when the oven is off.
 Duration	To set the length of cooking. Use only when a heating function is set.
 End Time	To set the oven turn-off time. Use only when a heating function is set.





Clock function	Application
 Time Delay	Combination of functions: Duration, End Time.
 Minute Minder	To set a countdown time. This function has no effect on the operation of the oven. Minute Minder - can be set at any time, also if the oven is off.

7.2 How to set: Time of day





After the first connection to the mains, wait until the display shows: **hr, 12:00**.
12 - flashes.

Step 1	Turn the knob for the temperature to set the hour.
Step 2	 - press to confirm. The display shows the set hour and: min. 00 - flashes.
Step 3	Turn the knob for the temperature to set the minutes.
Step 4	 - press to confirm. The display shows the set time.
 - press repeatedly to change the time of day.  - flashes in the display.	









7.3 How to set function: Duration

Step 1	Set a heating function.
Step 2	 - press repeatedly.  - starts to flash.
Step 3	Turn the control knob to set the minutes.  - press to confirm.
Step 4	Turn the knob for the temperature to set the hour.  - press to confirm. When the set time ends the signal sounds for 2 min. Time setting flashes in the display. The oven turns off automatically.
Step 5	Press any button to stop the signal.
Step 6	Turn the knob for the heating functions to the off position.

7.4 How to set function: End Time





Step 1	Set a heating function.
Step 2	 - press repeatedly.  - starts to flash.
Step 3	Turn the knob for the temperature to set the hour.  - press to confirm.
Step 4	Turn the knob for the temperature to set the minutes.  - press to confirm. At the set end time the signal sounds for 2 min. The time setting flashes in the display. The oven turns off automatically.
Step 5	Press any button to stop the signal.
Step 6	Turn the knob for the heating functions to the off position.

7.5 How to set function: Time Delay

Step 1	Set a heating function.
Step 2	 - press repeatedly.  - starts to flash.
Step 3	Turn the knob for the temperature to set the minutes for the function: Duration. Press:  .
Step 4	Turn the knob for the temperature to set the hour for the function: Duration. Press:  The display shows:  .
Step 5	Turn the knob for the temperature to set the hour for the function: End Time. Press:  .
Step 6	Turn the knob for the temperature to set the minutes for the function: End Time. Press:  .
<p>The display shows: the set temperature,  .</p> <p>Oven turns on automatically later on, works for the set Duration time and stops at the set End Time.</p> <p>At the set End Time the signal sounds for 2 min. The time setting flashes in the display. The oven turns off.</p>	
Step 7	Press any button to stop the signal.
Step 8	Turn the knob for the heating functions to the off position.

7.6 How to set function: Minute Minder

Minute minder can be both set when the oven is turned on and off.

Step 1	  - press repeatedly.  00 - flash.
Step 2	Turn the knob for the temperature to set the seconds and then the minutes. When the time you set is longer than 60 min, hr flashes in the display.
Step 3	Set the hours. Minute Minder - starts automatically after 5 sec. After 90% of the set time the signal sounds.
Step 4	When the set time ends the signal sounds for 2 min. 00:00 ,  - flash in the display. Press any button to stop the signal.

8. USING THE ACCESSORIES



WARNING!

Refer to Safety chapters.

8.1 Core temperature sensor

The core temperature sensor measures temperature inside the food. When the food is at the set temperature, the oven turns off.

There are two temperatures to be set:

- the oven temperature (minimum 120 °C),
- the food core temperature.



CAUTION!

Use only the core temperature sensor supplied and the original replacement parts.

For the best cooking results:

- Ingredients should be at room temperature.
- Core temperature sensor cannot be used for liquid dishes.
- During cooking the core temperature sensor must remain in the dish and the plug in the socket.
- Use recommended food core temperature settings. Refer to "Hints and tips" chapter.



Every time you put the core temperature sensor in the socket, you need to set the core temperature time again. You cannot select the duration and end time.



The oven calculates the approximate cooking time, it may change during cooking.

Food categories: meat, poultry and fish

1. Set the oven function and temperature.
2. Insert the tip of the core temperature sensor into the centre of meat or fish, in the thickest part if possible. Make sure that at least 3/4 of the core temperature sensor is inside of the dish.
3. Put the plug of the core temperature sensor into the socket located in the front frame of the appliance.

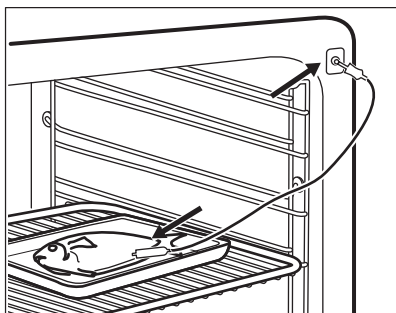
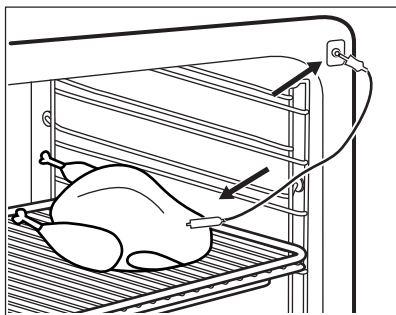

The display shows the core temperature sensor symbol.

When you use the core temperature sensor for the first time, the default core temperature is 60 °C.

While  flashes, you can use the knob for the temperature to change the default core temperature. The display shows the symbol of the core temperature sensor and the default core temperature.

4. Press  to save the new core temperature, or wait 10 seconds for the setting to be saved automatically.

The new default core temperature is displayed during the next use of the core temperature sensor.

When the food is at the set core temperature, the default core temperature and  flashes. An acoustic signal sounds for 2 minutes.

5. Press any button to stop the acoustic signal.
6. Remove the core temperature sensor plug from the socket and remove the dish from the appliance.



WARNING!

There is a risk of burns as the core temperature sensor becomes hot. Be careful when you unplug it and remove it from the dish.

Food category: casserole

1. Set the oven function and temperature.
2. Place half of the ingredients in a baking dish.
3. Insert the tip of the core temperature sensor exactly in the centre of the casserole. The core temperature sensor should be stabilized in one place during baking. Use a solid ingredient to achieve that. Use the rim of the baking dish to support the silicone handle of the core temperature sensor. The tip of the core temperature sensor should not touch the bottom of a baking dish.

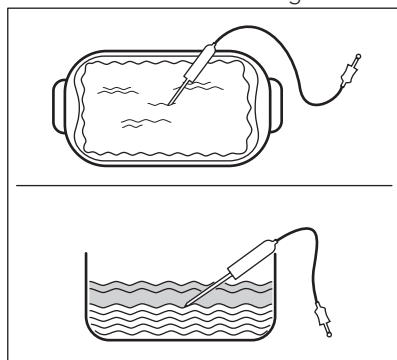

4. Cover the core temperature sensor with the remaining ingredients.
5. Put the plug of the core temperature sensor into the socket located in the front frame of the appliance.

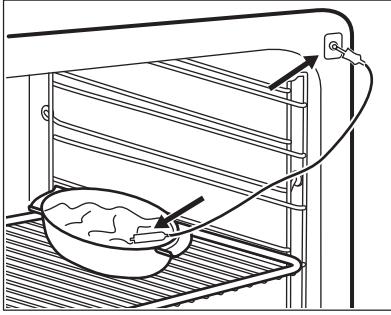

The display shows the core temperature sensor symbol.

6. Press to save the new core temperature, or wait 10 seconds for the setting to be saved automatically.

The new default core temperature is displayed during the next use of the core temperature sensor.

When the food is at the set core temperature, the default core temperature and flashes. An acoustic signal sounds for 2 minutes.

7. Press any button to stop the acoustic signal.
8. Remove the core temperature sensor plug from the socket and remove the dish from the appliance.



WARNING!

There is a risk of burns as the core temperature sensor becomes hot. Be careful when you unplug it and remove it from the dish.

Changing the temperature during the cooking

You can change the temperature at any time during the cooking:

1. Press $^{\circ}\text{C}$:
 - one time - the display shows the set core temperature which changes every 10 seconds to the current core temperature.
 - two times - the display shows the current oven temperature which changes every 10 seconds to the set oven temperature.
 - three times - the display shows the set oven temperature.
2. Use the knob for the temperature to change the temperature.

8.2 Inserting accessories

A small indentation at the top increases safety. The indentations are also anti-tip devices. The high rim around the shelf prevents cookware from slipping of the shelf.

Wire shelf:

Push the shelf between the guide bars of the shelf support.

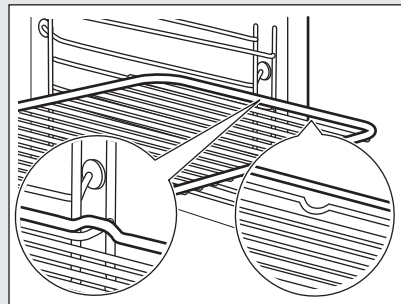

Deep pan:

Push the deep pan between the guide bars of the shelf support.

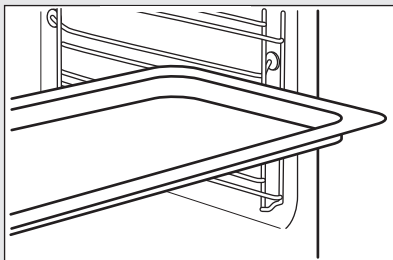
**Wire shelf and deep pan together:**

Push the deep pan between the guide bars of the shelf support and the wire shelf on the guide bars above.

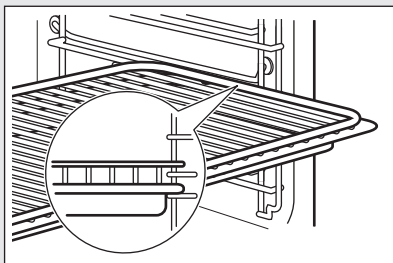

8.3 Trivet and Grill- / Roasting pan

You can use the trivet to roast larger pieces of meat or poultry on one shelf position.

Step 1 Put the trivet into a deep pan. Make sure the supports of the wire shelf point up.

Step 2 Put the deep pan on the recommended shelf position.

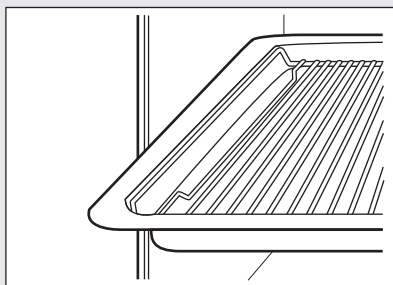

You can use the trivet to grill thin pieces of food in large quantities and to toast them.

Step 1 Put the trivet into a deep pan. Make sure the supports of the wire shelf point up.

Step 2 Put the deep pan on the recommended shelf position.

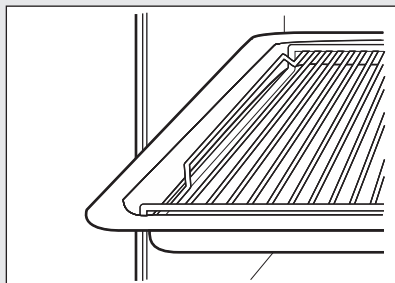

9. ADDITIONAL FUNCTIONS

9.1 Using Child lock

When the Child lock is on the oven cannot be turned on accidentally.

1. Ensure the knob for the heating functions is in the off position.
2. , °C - press and hold at the same time for 2 seconds.

The signal sounds. **SAFE** - appears on the display.

To turn off the Child Lock, repeat the step 2.

9.2 Using function lock

You can turn on the Function Lock function only when the oven works.

When the Function lock is on the temperature and time settings cannot be changed accidentally.

1. Select an oven function and set it according your preferences.
2. Press and hold and °C at the same time for 2 seconds.

The signal sounds. **Loc** appears on the display for 5 seconds.



Loc appears on the display when you turn the knob for the temperature or press any button when the Function lock is on.

When you turn the knob for the oven functions, the oven stops.

When you turn off the oven while the Function Lock is on, the Function Lock switches automatically to the Child Lock. Refer to "Additional functions" chapter, Using the Child Lock.

To turn off the Function Lock, repeat step 2.

9.3 Residual heat indicator

When you turn off the oven, the display shows the residual heat indicator if the temperature in the oven is more than 40 °C.

9.4 Automatic switch-off

For safety reasons the oven turns off after some time, if a heating function works and you do not change any settings.

(°C)	(h)
30 - 115	12.5
120 - 195	8.5
200 - 245	5.5
250 - maximum	3

After an automatic switch-off, press any button to operate the oven again.

The Automatic switch-off does not work with the functions: Light, Food Sensor, Duration, End Time.

surfaces of the oven cool. If you turn off the oven, the cooling fan can continue to operate until the oven cools down.

9.5 Cooling fan

When the oven operates, the cooling fan turns on automatically to keep the

10. HINTS AND TIPS



WARNING!

Refer to Safety chapters.

10.1 Cooking recommendations



The temperature and cooking times in the tables are guidelines only. They depend on the recipes and the quality and quantity of the ingredients used.

Your oven may bake or roast differently to the oven you had before. The tables below show recommended settings for temperature, cooking time and shelf position for specific types of the food.

If you cannot find the settings for a special recipe, look for the similar one.

10.2 Inner side of the door

On the inner side of the door you can find:

- the numbers of the shelf positions.
- information about the oven functions, recommended shelf positions and temperatures for dishes.

10.3 True Fan Cooking PLUS

Use the second shelf position.

Use 150 ml of water.

Use a baking tray.



**CAKES / PAS-
TRIES /
BREADS**



(°C)



(min)

Cookies / Scones / Croissants	150 - 180	10 - 20
-------------------------------------	-----------	---------

Focaccia	200 - 210	10 - 20
----------	-----------	---------



**CAKES / PAS-
TRIES /
BREADS**





(°C)



(min)



Pizza	230	10 - 20
Bread rolls	200	20 - 25
Bread	180	35 - 40
Plum cake / Apple pie / Cinnamon rolls, baked in a cake mould	160 - 180	30 - 60



Use 200 ml of water.

 FROZEN READY MEALS	 (°C)	 (min)
Pizza	200 - 210	10 - 20
Croissants	170 - 180	15 - 25
Lasagne	180 - 200	35 - 50

Use 100 ml of water.



Set the temperature to 110 °C.

 FOOD REGENERATION	 (min)
Bread rolls	10 - 20
Bread	15 - 25
Focaccia	15 - 25
Meat	15 - 25
Pasta	15 - 25
Pizza	15 - 25
Rice	15 - 25

 FOOD REGENERATION	 (min)
Vegetables	15 - 25

Use 200 ml of water.

Use a glass baking dish.

 ROASTING	 (°C)	 (min)
Roast beef	200	50 - 60
Chicken	210	60 - 80
Roast pork	180	65 - 80

10.4 Baking

For the first baking, use the lower temperature.

You can extend the baking time by 10 – 15 minutes if you bake cakes on more than one shelf position.

Cakes and pastries at different heights do not always brown equally. There is no need to change the temperature setting if an unequal browning occurs. The differences equalize during baking.







Trays in the oven can distort during baking. When the trays are cold again, the distortions disappear.







10.5 Tips on baking







Baking results	Possible cause	Remedy
The bottom of the cake is not baked sufficiently.	The shelf position is incorrect.	Put the cake on a lower shelf.
The cake sinks and becomes soggy or streaky.	The oven temperature is too high.	Next time set slightly lower oven temperature.
	The oven temperature is too high and the baking time is too short.	Next time set a longer baking time and lower oven temperature.









Baking results	Possible cause	Remedy
The cake is too dry.	The oven temperature is too low.	Next time set higher oven temperature.
	The baking time is too long.	Next time set shorter baking time.
The cake bakes unevenly.	The oven temperature is too high and the baking time is too short.	Next time set a longer baking time and lower oven temperature.
	The cake batter is not evenly distributed.	Next time spread the cake batter evenly on the baking tray.
The cake is not ready in the baking time specified in a recipe.	The oven temperature is too low.	Next time set a slightly higher oven temperature.

10.6 Baking on one shelf level

 BAKING IN TINS					
		 (°C)	 (min)		
Flan base - short pastry, preheat the empty oven	True Fan Cooking	170 - 180	10 - 25	2	
Flan base - sponge cake mixture	True Fan Cooking	150 - 170	20 - 25	2	
Ring cake / Brioche	True Fan Cooking	150 - 160	50 - 70	1	
Madeira cake / Fruit cakes	True Fan Cooking	140 - 160	70 - 90	1	
Cheesecake	Conventional Cooking	170 - 190	60 - 90	1	

 CAKES / PASTRIES / BREADS		
 Use the third shelf position.		
 Use the function: True Fan Cooking.		
 Use a baking tray.		
	 (°C)	 (min)
Cake with crumble topping	150 - 160	20 - 40
Fruit flans (made of yeast dough / sponge cake mixture), use a deep pan	150	35 - 55

 CAKES / PASTRIES / BREADS		
 Use the third shelf position.		
 Use the function: True Fan Cooking.		
 Use a baking tray.		
	 (°C)	 (min)
Fruit flans made of short pastry	160 - 170	40 - 80

 CAKES / PASTRIES / BREADS			
 Preheat the empty oven.			
 Use the function: Conventional Cooking.			
 Use a baking tray.			
	 (°C)	 (min)	
Swiss roll	180 - 200	10 - 20	3
Rye bread:	first: 230	20	1
	then: 160 - 180	30 - 60	
Buttered almond cake / Sugar cakes	190 - 210	20 - 30	3



CAKES / PASTRIES / BREADS



Preheat the empty oven.



Use the function: Conventional Cooking.



Use a baking tray.



(°C)



(min)



	(°C)	(min)	
Cream puffs / Eclairs	190 - 210	20 - 35	3
Plaited bread / Bread crown	170 - 190	30 - 40	3
Fruit flans (made of yeast dough / sponge cake mix- ture), use a deep pan	170	35 - 55	3
Yeast cakes with deli- cate toppings (e.g. quark, cream, cus- tard)	160 - 180	40 - 80	3
Christstollen	160 - 180	50 - 70	2



BISCUITS



Use the third shelf position.









(°C)







(min)

	True Fan Cooking	(°C)	(min)
Short pastry biscuits	True Fan Cooking	150 - 160	10 - 20
Rolls, preheat the empty oven	True Fan Cooking	160	10 - 25
Biscuits made of sponge cake mixture	True Fan Cooking	150 - 160	15 - 20
Puff pastries, preheat the empty oven	True Fan Cooking	170 - 180	20 - 30

 BISCUITS			
 Use the third shelf position.			
		 (°C)	 (min)
Biscuits made of yeast dough	True Fan Cooking	150 - 160	20 - 40
Macaroons	True Fan Cooking	100 - 120	30 - 50
Pastries made of egg white / Meringues	True Fan Cooking	80 - 100	120 - 150
Rolls, preheat the empty oven	Conventional Cooking	190 - 210	10 - 25

10.7 Bakes and gratins





Use the first shelf position.







		 (°C)	 (min)
Baguettes topped with melted cheese	True Fan Cooking	160 - 170	15 - 30
Vegetables au gratin, preheat the empty oven	Turbo Grilling	160 - 170	15 - 30
Lasagne	Conventional Cooking	180 - 200	25 - 40
Fish bakes	Conventional Cooking	180 - 200	30 - 60
Stuffed vegetables	True Fan Cooking	160 - 170	30 - 60
Sweet bakes	Conventional Cooking	180 - 200	40 - 60
Pasta bake	Conventional Cooking	180 - 200	45 - 60

10.8 Multilevel Baking

Use the baking trays.

Use the function: True Fan Cooking.

 CAKES / PASTRIES			
	 (°C)	 (min)	 2 positions
Cream puffs / Eclairs, preheat the empty oven	160 - 180	25 - 45	1 / 4
Dry streusel cake	150 - 160	30 - 45	1 / 4

 BISCUITS / SMALL CAKES / PASTRIES / ROLLS				
	 (°C)	 (min)	 2 positions	 3 positions
Rolls	180	20 - 30	1 / 4	-
Short pastry biscuits	150 - 160	20 - 40	1 / 4	1 / 3 / 5
Biscuits made of sponge cake mixture	160 - 170	25 - 40	1 / 4	-
Puff pastries, preheat the empty oven	170 - 180	30 - 50	1 / 4	-
Biscuits made of yeast dough	160 - 170	30 - 60	1 / 4	-
Macaroons	100 - 120	40 - 80	1 / 4	-
Biscuits made of egg white / Meringues	80 - 100	130 - 170	1 / 4	-

10.9 Tips on Roasting

Use heat-resistant ovenware.

Roast lean meat covered (you can use aluminium foil).

Roast large meat joints directly in the tray or on the wire shelf placed above the tray.

Put some water in the tray to prevent dripping fat from burning.







Turn the roast after 1/2 - 2/3 of the cooking time.







Roast meat and fish in large pieces (1 kg or more).







Baste meat joints with their own juice several times during roasting.



















10.10 Roasting







Use the first shelf position.







 BEEF				
			 (°C)	 (min)
Pot roast	1 - 1.5 kg	Conventional Cooking	230	120 - 150
Roast beef or fillet, rare, preheat the empty oven	per cm of thickness	Turbo Grilling	190 - 200	5 - 6
Roast beef or fillet, medium, preheat the empty oven	per cm of thickness	Turbo Grilling	180 - 190	6 - 8
Roast beef or fillet, well done, preheat the empty oven	per cm of thickness	Turbo Grilling	170 - 180	8 - 10

 PORK				
 Use the function: Turbo Grilling.				
	 (kg)	 (°C)	 (min)	
Shoulder / Neck / Ham joint	1 - 1.5	160 - 180	90 - 120	
Chops / Spare rib	1 - 1.5	170 - 180	60 - 90	
Meatloaf	0.75 - 1	160 - 170	50 - 60	
Pork knuckle, precooked	0.75 - 1	150 - 170	90 - 120	





 VEAL				
 Use the function: Turbo Grilling.				
	 (kg)	 (°C)	 (min)	
Roast veal	1	160 - 180	90 - 120	





 VEAL				
 Use the function: Turbo Grilling.				
	 (kg)	 (°C)	 (min)	
Veal knuckle	1.5 - 2	160 - 180	120 - 150	
 LAMB				
 Use the function: Turbo Grilling.				
	 (kg)	 (°C)	 (min)	
Lamb leg / Roast lamb	1 - 1.5	150 - 170	100 - 120	
Lamb saddle	1 - 1.5	160 - 180	40 - 60	
 GAME				
 Use the function: Conventional Cooking.				
	 (kg)	 (°C)	 (min)	
Saddle / Hare leg, preheat the empty oven	up to 1	230	30 - 40	
Venison saddle	1.5 - 2	210 - 220	35 - 40	
Haunch of venison	1.5 - 2	180 - 200	60 - 90	





 POULTRY			
 Use the function: Turbo Grilling.			
	 (kg)	 (°C)	 (min)
Poultry, portions	0.2 - 0.25 each	200 - 220	30 - 50
Chicken, half	0.4 - 0.5 each	190 - 210	35 - 50
Chicken, poulard	1 - 1.5	190 - 210	50 - 70
Duck	1.5 - 2	180 - 200	80 - 100
Goose	3.5 - 5	160 - 180	120 - 180
Turkey	2.5 - 3.5	160 - 180	120 - 150
Turkey	4 - 6	140 - 160	150 - 240







 FISH (STEAMED)			
 Use the function: Conventional Cooking.			
	 (kg)	 (°C)	 (min)
Whole fish	1 - 1.5	210 - 220	40 - 60







10.11 Crispy baking with: Pizza Function

 PIZZA		
 Use the first shelf position.		
	 (°C)	 (min)
Tarts	180 - 200	40 - 55
Spinach flan	160 - 180	45 - 60

 PIZZA		
 Use the first shelf position.		
	 (°C)	 (min)
Quiche lor- raine / Swiss flan	170 - 190	45 - 55
Cheesecake	140 - 160	60 - 90







 PIZZA		
 Use the first shelf position.		
	 (°C)	 (min)
Vegetable pie	160 - 180	50 - 60







 PIZZA		
 Preheat the empty oven before cooking.		
 Use the second shelf position.		
	 (°C)	 (min)
Pizza, thin crust, use a deep pan	200 - 230	15 - 20
Pizza, thick crust	180 - 200	20 - 30

 PIZZA		
 Preheat the empty oven before cooking.		
 Use the second shelf position.		
	 (°C)	 (min)
Unleavened bread	230 - 250	10 - 20
Puff pastry flan	160 - 180	45 - 55
Flammkuchen	230 - 250	12 - 20
Pierogi	180 - 200	15 - 25







10.12 Grill

Preheat the empty oven before cooking.
 Grill only thin pieces of meat or fish.
 Put a pan on the first shelf position to collect fat.

 GRILL				
 Use the function: Grill				
	 (°C)	 (min) 1st side	 (min) 2nd side	
Roast beef	210 - 230	30 - 40	30 - 40	2
Beef fillet	230	20 - 30	20 - 30	3
Pork loin	210 - 230	30 - 40	30 - 40	2

 GRILL				
 Use the function: Grill				
	 (°C)	 (min) 1st side	 (min) 2nd side	
Veal loin	210 - 230	30 - 40	30 - 40	2
Lamb saddle	210 - 230	25 - 35	20 - 25	3
Whole fish, 0.5 kg - 1 kg	210 - 230	15 - 30	15 - 30	3 / 4

10.13 Frozen Foods

 DEFROSTING				
 Use the function: True Fan Cooking.				
	 (°C)	 (min)		
Pizza, frozen	200 - 220	15 - 25	2	
Pizza American, frozen	190 - 210	20 - 25	2	
Pizza, chilled	210 - 230	13 - 25	2	
Pizza snacks, frozen	180 - 200	15 - 30	2	
French fries, thin	200 - 220	20 - 30	3	
French fries, thick	200 - 220	25 - 35	3	
Wedges / Croquettes	220 - 230	20 - 35	3	
Hash browns	210 - 230	20 - 30	3	
Lasagne / Cannelloni, fresh	170 - 190	35 - 45	2	
Lasagne / Cannelloni, frozen	160 - 180	40 - 60	2	
Baked cheese	170 - 190	20 - 30	3	
Chicken wings	190 - 210	20 - 30	2	

10.14 Defrost





Remove the food packaging and put the food on a plate.

Do not cover the food, as this can extend the defrost time.

For large portions of food place an upturned empty plate on the bottom of

Use the first shelf position.

the oven cavity. Put the food in a deep dish and set it on top of the plate inside the oven. Remove the shelf supports if necessary.

	 (kg)	 (min) Defrosting time	 (min) Further defrosting time	
Chicken	1	100 - 140	20 - 30	Turn halfway through.
Meat	1	100 - 140	20 - 30	Turn halfway through.
Trout	0.15	25 - 35	10 - 15	-
Strawberries	0.3	30 - 40	10 - 20	-
Butter	0.25	30 - 40	10 - 15	-
Cream	2 x 0.2	80 - 100	10 - 15	Whip the cream when still slightly frozen in places.
Gateau	1.4	60	60	-

10.15 Preserving

Use the function Bottom Heat.

Use only preserve jars of the same dimensions available on the market.

Do not use jars with twist-off and bayonet type lids or metal tins.

Use the first shelf position.

Put no more than six one-litre preserve jars on the baking tray.

Fill the jars equally and close with a clamp.



The jars cannot touch each other.



Put approximately 1/2 litre of water into the baking tray to give sufficient moisture in the oven.

When the liquid in the jars starts to simmer (after approximately 35 - 60 minutes with one-litre jars), stop the oven or decrease the temperature to 100 °C (see the table).

Set the temperature to 160 - 170 °C.

 SOFT FRUIT	 (min) Cooking time until simmering
Strawberries / Blueberries / Raspberries / Ripe gooseberries	35 - 45



 STONE FRUIT	 (min) Cooking time until simmering	 (min) Continue to cook at 100 °C
Peaches / Quinces / Plums	35 - 45	10 - 15



 VEG- ETABLES	 (min) Cooking time until simmering	 (min) Continue to cook at 100 °C
Carrots	50 - 60	5 - 10
Cucumbers	50 - 60	-
Mixed pickles	50 - 60	5 - 10
Kohlrabi / Peas / Aspar- agus	50 - 60	15 - 20

10.16 Dehydrating - True Fan Cooking

Cover trays with grease proof paper or baking parchment.

10.17 Food Sensor



 BEEF	 Food core temperature (°C)		
	Rare	Medium	Well done
Roast beef	45	60	70
Sirloin	45	60	70

 BEEF	 Food core temperature (°C)		
	Less	Medium	More
Meatloaf	80	83	86



For a better result, stop the oven halfway through the drying time, open the door and let it cool down for one night to complete the drying.



For 1 tray use the third shelf position.



For 2 trays use the first and fourth shelf position.



 VEGETA- BLES	 (°C)	 (h)
Beans	60 - 70	6 - 8
Peppers	60 - 70	5 - 6
Vegetables for soup	60 - 70	5 - 6
Mushrooms	50 - 60	6 - 8
Herbs	40 - 50	2 - 3



Set the temperature to 60 - 70 °C.



 FRUIT	 (h)
Plums	8 - 10
Apricots	8 - 10
Apple slices	6 - 8
Pears	6 - 9



 PORK	 Food core temperature (°C)		
	Less	Medium	More
Ham / Roast	80	84	88
Saddle chop / Pork loin, smoked / Pork loin, poached	75	78	82



 VEAL	 Food core temperature (°C)		
	Less	Medium	More
Roast veal	75	80	85
Veal knuckle	85	88	90



 MUTTON / LAMB	 Food core temperature (°C)		
	Less	Medium	More
Mutton leg	80	85	88
Mutton saddle	75	80	85
Roast lamb / Lamb leg	65	70	75



 GAME	 Food core temperature (°C)		
	Less	Medium	More
Hare saddle / Venison saddle	65	70	75
Hare leg / Hare, whole / Venison leg	70	75	80

 POULTRY	 Food core temperature (°C)		
	Less	Medium	More
Chicken	80	83	86
Duck, whole / half / Turkey, whole / breast	75	80	85
Duck, breast	60	65	70

 FISH (SALMON, TROUT, ZANDER)	 Food core temperature (°C)		
	Less	Medium	More
Fish, whole / large / steamed / Fish, whole / large / roasted	60	64	68

 CASSEROLES - PRE-COOKED VEGETABLES	 Food core temperature (°C)		
	Less	Medium	More
Zucchini casserole / Broccoli casserole / Fennel casserole	85	88	91





 CASSEROLES - SAVOURY	 Food core temperature (°C)		
	Less	Medium	More
Cannelloni / Lasagne / Pasta bake	85	88	91

 CASSEROLES - SWEET	 Food core temperature (°C)		
	Less	Medium	More
White bread casserole with / without fruit / Rice porridge casserole with / without fruit / Sweet noodle casserole	80	85	90

10.18 Moist Fan Baking - recommended accessories

absorption than the light colour and reflective dishes.



Use the dark and non-reflective tins and containers. They have better heat

			
Pizza pan	Baking dish	Ramekins	Flan base tin
Dark, non-reflective 28 cm diameter	Dark, non-reflective 26 cm diameter	Ceramic 8 cm diameter, 5 cm height	Dark, non-reflective 28 cm diameter

10.19 Moist Fan Baking







For the best results follow suggestions listed in the table below.







Use the third shelf position.







	 (°C)	 (min)
Pasta gratin	200 - 220	45 - 55
Potato gratin	180 - 200	70 - 85
Moussaka	170 - 190	70 - 95
Lasagne	180 - 200	75 - 90
Cannelloni	180 - 200	70 - 85
Bread pudding	190 - 200	55 - 70
Rice pudding	170 - 190	45 - 60
Apple cake, made of sponge cake mixture (round cake tin)	160 - 170	70 - 80
White bread	190 - 200	55 - 70







10.20 Information for test institutes







Tests according to: EN 60350, IEC 60350.

 BAKING ON ONE LEVEL. Baking in tins				
		 (°C)	 (min)	
Fatless sponge cake	True Fan Cooking	140 - 150	35 - 50	2
Fatless sponge cake	Conventional Cooking	160	35 - 50	2
Apple pie, 2 tins Ø20 cm	True Fan Cooking	160	60 - 90	2
Apple pie, 2 tins Ø20 cm	Conventional Cooking	180	70 - 90	1

 BAKING ON ONE LEVEL. Biscuits				
 Use the third shelf position.				
		 (°C)	 (min)	
Short bread / Pastry strips	True Fan Cooking	140	25 - 40	
Short bread / Pastry strips, preheat the empty oven	Conventional Cooking	160	20 - 30	
Small cakes, 20 per tray, preheat the empty oven	True Fan Cooking	150	20 - 35	
Small cakes, 20 per tray, preheat the empty oven	Conventional Cooking	170	20 - 30	

 MULTILEVEL BAKING. Biscuits				
		 (°C)	 (min)	
Short bread / Pastry strips	True Fan Cooking	140	25 - 45	1 / 4
Small cakes, 20 per tray, preheat the empty oven	True Fan Cooking	150	23 - 40	1 / 4
Fatless sponge cake	True Fan Cooking	160	35 - 50	1 / 4



 GRILL				
 Preheat the empty oven for 5 minutes.				
 Grill with the maximum temperature setting.				
		 (min)		
Toast	Grill	1 - 3	5	

 GRILL			
 Preheat the empty oven for 5 minutes.			
 Grill with the maximum temperature setting.			
		 (min)	
Beef steak, turn halfway through	Grill	24 - 30	4

11. CARE AND CLEANING

 **WARNING!**
Refer to Safety chapters.

11.1 Notes on cleaning

 Cleaning Agents	Clean the front of the oven with a soft cloth with warm water and a mild detergent.
	Use a cleaning solution to clean metal surfaces.
 Everyday Use	Clean the cavity after each use. Fat accumulation or other residue may cause fire.
	Dry the cavity with a soft cloth after each use.
 Accessories	Clean all accessories after each use and let them dry. Use a soft cloth with warm water and a mild detergent. Do not clean the accessories in a dishwasher.
	Do not clean the non-stick accessories using abrasive cleaner or sharp-edged objects.

11.2 How to clean: Cavity embossment

Clean the cavity embossment to remove limestone residue after cooking with steam.

Step 1	Step 2	Step 3
Pour: 250 ml of white vinegar into the cavity embossment. Use maximum 6% vinegar without any additives.	Let the vinegar dissolve the limestone residue at the ambient temperature for 30 minutes.	Clean the cavity with warm water and a soft cloth.
For the function: True Fan Cooking PLUS clean the oven for every 5 - 10 cooking cycles.		

11.3 How to remove: Shelf supports

Remove the shelf supports to clean the oven.

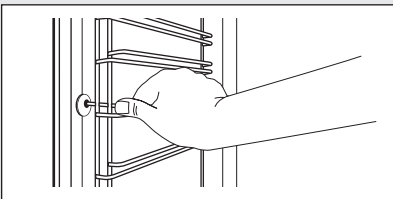
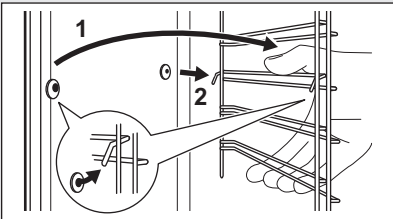
Step 1	Turn off the oven and wait until it is cold.	
Step 2	Pull the front of the shelf support away from the side wall.	
Step 3	Pull the rear end of the shelf support away from the side wall and remove it.	
Step 4	Install the shelf supports in the opposite sequence.	

11.4 How to use: Catalytic cleaning

Spots or discolouration of the catalytic coating have no effect on the cleaning.

The cavity is coated with catalytic enamel. It absorbs fat during catalysis.

Before the catalytic cleaning		
Turn off the oven and wait until it is cold.	Remove all accessories and removable shelf supports.	Clean the oven floor and the inner door glass with warm water, soft cloth and mild detergent.
Clean the oven with catalytic cleaning		
Step 1	Step 2	Step 3

Clean the oven with catalytic cleaning

Set the function and the oven temperature:  250 °C

After cleaning, turn the knob for the oven functions to the off position. When the cleaning ends the signal sounds. Press any button to turn off the signal.

When the oven is cold, clean the cavity with a wet soft cloth.

To stop the cleaning before it finishes turn the knob for the heating functions to the off position.

11.5 Cleaning reminder

The oven reminds you when to clean the oven with: catalytic cleaning.

CATA - flashes in the display for 10 sec after each activation and deactivation of the oven.



 3sec, °C - press at the same time to turn off the reminder.

number of glass panels is different for different models.



WARNING!

The door is heavy.



CAUTION!

Carefully handle the glass, especially around the edges of the front panel. The glass can break.

11.6 How to remove and install: Door

You can remove the door and the internal glass panels to clean it. The

- Step 1** Fully open the door.
- Step 2** Fully press the clamping levers (A) on the two door hinges.

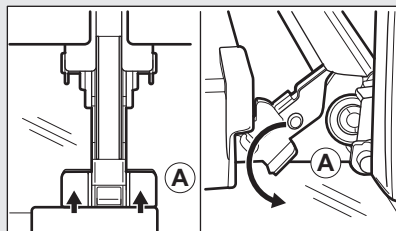

- Step 3** Close the oven door to the first opening position (approximately 70° angle). Hold the door at both sides and pull it away from the oven at an upwards angle. Put the door with the outer side down on a soft cloth on a stable surface.

Step 4	Hold the door trim (B) on the top edge of the door at the two sides and push inwards to release the clip seal.	
Step 5	Pull the door trim to the front to remove it.	
Step 6	Hold the door glass panels on their top edge one by one and pull them up out of the guide.	
Step 7	Clean the glass panel with water and soap. Dry the glass panel carefully. Do not clean the glass panels in the dishwasher.	
Step 8	After cleaning, do the above steps in the opposite sequence.	
Step 9	Install the smaller panel first, then the larger and the door. Make sure that the glasses are inserted in the correct position otherwise the surface of the door may overheat.	

11.7 How to replace: Lamp



WARNING!

Risk of electric shock.
The lamp can be hot.

Before you replace the lamp:		
Step 1	Step 2	Step 3
Turn off the oven. Wait until the oven is cold.	Disconnect the oven from the mains.	Put a cloth on the bottom of the cavity.

Top lamp

Step 1 Turn the glass cover to remove it.

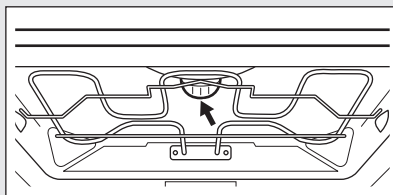

Step 2 Clean the glass cover.

Step 3 Replace the lamp with a suitable 300 °C heat-resistant lamp.

Step 4 Install the glass cover.

12. TROUBLESHOOTING



WARNING!
Refer to Safety chapters.

12.1 What to do if...



The oven does not turn on or does not heat up

Possible cause	Remedy
The oven is not connected to an electrical supply or it is connected incorrectly.	Check if the oven is correctly connected to the electrical supply (refer to the connection diagram if available).
The oven is deactivated.	Activate the oven.
The clock is not set.	Set the clock.
The necessary settings are not set.	Make sure that the settings are correct.
The automatic switch-off is activated.	Refer to "Automatic switch-off".
The fuse is blown.	Make sure that the fuse is the cause of the malfunction. If the fuse is blown again and again, contact a qualified electrician.
The oven Child Lock is on.	Refer to "Using the Child Lock".



Problems with components

Description	Possible cause	Remedy
The lamp does not operate.	The lamp is defective.	Replace the lamp.



Problems with components

Description	Possible cause	Remedy
The food sensor does not operate.	The plug of the food sensor is not correctly installed into the socket.	Put the plug of the food sensor as far as possible into the socket.



Display shows:

Description	Possible cause	Remedy
The display shows "C2".	You want to start the Catalysis or Defrost function, but you did not remove the food sensor plug from the socket.	Remove the food sensor plug from the socket.
The display shows an error code that is not in this table.	There is an electrical fault.	<ul style="list-style-type: none"> Deactivate the oven with the house fuse or the safety switch in the fuse box and activate it again. If the display shows the error code again, contact the Customer Care Department.



Problems with cleaning procedure

Description	Possible cause	Remedy
Steam and condensation settle on the food and in the cavity of the oven.	You left the dish in the oven for too long.	Do not leave the dishes in the oven for longer than 15 - 20 minutes after the cooking process ends.
You want to activate the cleaning function, but the display shows "C4".	The Plus Steam is pressed.	Press the Plus Steam again.
The water in the cavity embossment does not boil.	The temperature is too low.	Set the temperature at least to 110 °C. Refer to "Hints and tips" chapter.



Problems with cleaning procedure

Description	Possible cause	Remedy
The water comes out of the cavity embossment.	There is too much water in the cavity embossment.	Deactivate the oven and make sure that the appliance is cold. Wipe the water with a cloth or sponge. Add the correct amount of water to the cavity embossment. Refer to the specific procedure.





Other problems

Description	Possible cause	Remedy
There is no good cooking performance using the function: True Fan Cooking PLUS.	You did not turn on correctly the function: True Fan Cooking PLUS with the Plus Steam.	Refer to "Setting the function: True Fan Cooking PLUS".
There is no good cooking performance using the function: True Fan Cooking PLUS.	You did not fill the cavity embossment with water.	Refer to "Setting the function: True Fan Cooking PLUS".
You want to activate the True Fan Cooking PLUS function, but the Plus Steam indicator does not switch on.	You did not select the heating function that support Plus Steam.	Refer to "Setting the function: True Fan Cooking PLUS".
You want to activate the True Fan Cooking PLUS function, but the Plus Steam indicator does not switch on.	The Plus Steam does not work.	Deactivate the appliance with the house fuse or the safety switch in the fuse box and activate it again. Refer to "Setting the function: True Fan Cooking PLUS".



Other problems

Description	Possible cause	Remedy
The appliance is activated and does not heat up. The fan does not operate. The display shows " Demo ".	The demo mode is activated.	<ol style="list-style-type: none"> 1. Deactivate the oven. 2. Press and hold at the same time  3sec  °C. 3. The first digit on the display and Demo indicator start to blink. 4. Enter the code 2468 by turning the knob for the temperature right or left to change the values and press  to confirm. 5. The next digit starts to blink. 6. Demo mode deactivates when you confirm the last digit and the code is correct.

12.2 Service data

If you cannot find a solution to the problem yourself, contact your dealer or an Authorised Service Centre.

The necessary data for the service centre is on the rating plate. The rating plate is

on the front frame of the oven cavity. Do not remove the rating plate from the oven cavity.

We recommend that you write the data here:	
Model (MOD.)
Product number (PNC)
Serial number (S.N.)

13. ENERGY EFFICIENCY

13.1 Product Information and Product Information Sheet*

Supplier's name	AEG
Model identification	BCK556220M 944188380 BCS556020M 944188382

Energy Efficiency Index	81.2	
Energy efficiency class	A+	
Energy consumption with a standard load, conventional mode	1.09 kWh/cycle	
Energy consumption with a standard load, fan-forced mode	0.69 kWh/cycle	
Number of cavities	1	
Heat source	Electricity	
Volume	71 l	
Type of oven	Built-In Oven	
Mass	BCK556220M	33.5 kg
	BCS556020M	33.5 kg

* For European Union according to EU Regulations 65/2014 and 66/2014.

For Republic of Belarus according to STB 2478-2017, Appendix G; STB 2477-2017, Annexes A and B.

For Ukraine according to 568/32020.

Energy efficiency class is not applicable for Russia.

EN 60350-1 - Household electric cooking appliances - Part 1: Ranges, ovens, steam ovens and grills - Methods for measuring performance.

13.2 Energy saving



The oven contains features which help you save energy during everyday cooking.

Make sure that the oven door is closed properly when the oven operates. Do not open the door too often during cooking. Keep the door gasket clean and make sure it is well fixed in its position.

Use metal cookware to improve energy saving.

When possible, do not preheat the oven before cooking.

Keep breaks between baking as short as possible when you prepare a few dishes at one time.

Cooking with fan

When possible, use the cooking functions with fan to save energy.

Residual heat

If a programme with the Duration or End Time selection is activated and the cooking time is longer than 30 minutes, the heating elements automatically turn off earlier in some oven functions.

The fan and lamp continue to operate. When you turn off the oven, the display shows the residual heat. You can use that heat to keep the food warm.

When the cooking duration is longer than 30 minutes, reduce the oven temperature to minimum 3 - 10 minutes before the end of cooking. The residual heat inside the oven will continue to cook.

Use the residual heat to warm up other dishes.

Keep food warm

Choose the lowest possible temperature setting to use residual heat and keep a meal warm. The residual heat indicator or temperature appears on the display.

Moist Fan Baking

Function designed to save energy during cooking.

When you use this function the lamp automatically turns off after 30 seconds.

14. ENVIRONMENTAL CONCERNS

Recycle materials with the symbol . Put the packaging in relevant containers to recycle it. Help protect the environment and human health by recycling waste of electrical and electronic appliances. Do not dispose of

appliances marked with the symbol  with the household waste. Return the product to your local recycling facility or contact your municipal office.

www.aeg.com/shop



867361142-A-062020



AEG