

User Manual

GETTING STARTED? EASY.



ZCK66350BA
ZCK66350WA
ZCK66350XA

EN User Manual
Cooker

GB

IE

ZANUSSI

SAFETY INFORMATION

Before the installation and use of the appliance, carefully read the supplied instructions. The manufacturer is not responsible for any injuries or damages that are the result of incorrect installation or usage. Always keep the instructions in a safe and accessible location for future reference.

CHILDREN AND VULNERABLE PEOPLE SAFETY



WARNING!

Risk of suffocation, injury or permanent disability.

- This appliance can be used by children aged from 8 years and above and persons with reduced physical, sensory or mental capabilities or lack of experience and knowledge if they have been given supervision or instruction concerning the use of the appliance in a safe way and understand the hazards involved.
- Children between 3 and 8 years of age and persons with very extensive and complex disabilities shall be kept away from the appliance unless continuously supervised.
- Children of less than 3 years of age should be kept away from the appliance unless continuously supervised.
- Do not let children play with the appliance.
- Keep all packaging away from children and dispose of it appropriately.
- Keep children and pets away from the appliance when it operates or when it cools down. Accessible parts are hot.
- Children shall not carry out cleaning and user maintenance of the appliance without supervision.

GENERAL SAFETY

- Only a qualified person must install this appliance and replace the cable.
- This appliance must be connected to the mains with a H05VV-F type cable to withstand the temperature of the rear panel.
- This appliance is intended for use up to an altitude of 2000 m above sea level.

- This appliance is not intended to be used on ships, boats or vessels.
- Do not install the appliance behind a decorative door in order to avoid overheating.
- Do not install the appliance on a platform.
- Do not operate the appliance by means of an external timer or separate remote-control system.
- **WARNING:** Unattended cooking on a hob with fat or oil can be dangerous and may result in fire.
- **NEVER** try to extinguish a fire with water, but switch off the appliance and then cover flame e.g. with a lid or a fire blanket.
- **CAUTION:** The cooking process has to be supervised. A short term cooking process has to be supervised continuously.
- **WARNING:** Danger of fire: Do not store items on the cooking surfaces.
- Do not use a steam cleaner to clean the appliance.
- Do not use harsh abrasive cleaners or sharp metal scrapers to clean the glass door or the glass of hinged lids of the hob since they can scratch the surface, which may result in shattering of the glass.
- Metallic objects such as knives, forks, spoons and lids should not be placed on the hob surface since they can get hot.
- Remove any spillage from the lid before opening. Let the hob surface cool down before closing the lid.
- **WARNING:** The appliance and its accessible parts become hot during use. Care should be taken to avoid touching heating elements.
- Always use oven gloves to remove or put in accessories or ovenware.
- Before maintenance, cut the power supply.
- If the mains power supply cable is damaged, it must be replaced by the manufacturer, its Authorised Service Centre or similarly qualified persons to avoid an electrical hazard.
- To remove the shelf supports first pull the front of the shelf support and then the rear end away from the side walls. Install the shelf supports in the opposite sequence.

- The means for disconnection must be incorporated in the fixed wiring in accordance with the wiring rules.
- **WARNING:** Use only hob guards designed by the manufacturer of the cooking appliance or indicated by the manufacturer of the appliance in the instructions for use as suitable or hob guards incorporated in the appliance. The use of inappropriate guards can cause accidents.

SAFETY INSTRUCTIONS

This appliance is suitable for the following markets:



INSTALLATION



WARNING! Only a qualified person must install this appliance.

- Remove all the packaging.
- Do not install or use a damaged appliance.
- Follow the installation instructions supplied with the appliance.
- Always take care when moving the appliance as it is heavy. Always use safety gloves and enclosed footwear.
- Do not pull the appliance by the handle.
- The kitchen cabinet and the recess must have suitable dimensions.
- Keep the minimum distance from other appliances and units.
- Install the appliance in a safe and suitable place that meets installation requirements.
- Parts of the appliance carry current. Close the appliance with furniture to prevent touching the dangerous parts.
- The sides of the appliance must stay next to appliances or units with the same height.
- Do not install the appliance adjacent to a door or under a window. This prevents hot cookware to fall from the appliance when the door or the window is opened.
- Make sure to install a stabilizing means in order to prevent tipping of the appliance. Refer to Installation chapter.
- The appliance must be earthed.
- Make sure that the parameters on the rating plate are compatible with the electrical ratings of the mains power supply.
- Always use a correctly installed shockproof socket.
- Do not use multi-plug adapters and extension cables.
- Do not let mains cables touch or come near the appliance door or the niche below the appliance, especially when it operates or the door is hot.
- The shock protection of live and insulated parts must be fastened in such a way that it cannot be removed without tools.
- Connect the mains plug to the mains socket only at the end of the installation. Make sure that there is access to the mains plug after the installation.
- If the mains socket is loose, do not connect the mains plug.
- Do not pull the mains cable to disconnect the appliance. Always pull the mains plug.
- Use only correct isolation devices: line protecting cut-outs, fuses (screw type fuses removed from the holder), earth leakage trips and contactors.
- The electrical installation must have an isolation device which lets you disconnect the appliance from the mains at all poles. The isolation device must have a contact opening width of minimum 3 mm.
- Fully close the appliance door before you connect the mains plug to the mains socket.

ELECTRICAL CONNECTION



WARNING! Risk of fire and electric shock.

- All electrical connections should be made by a qualified electrician.

GAS CONNECTION

- All gas connections should be made by a qualified person.
- Before installation, make sure that the local distribution conditions (nature of the gas and gas pressure) and the adjustment of the appliance are compatible.

- Make sure that there is air circulation around the appliance.
- The information about the gas supply is on the rating plate.
- This appliance is not connected to a device, which evacuates the products of combustion. Make sure to connect the appliance according to current installation regulations. Pay attention to requirements regarding adequate ventilation.

USE



WARNING! Risk of injury and burns.
Risk of electrical shock.

- This appliance is for household use only.
- Do not change the specification of this appliance.
- Make sure that the ventilation openings are not blocked.
- Do not let the appliance stay unattended during operation.
- Deactivate the appliance after each use.
- Be careful when you open the appliance door while the appliance is in operation. Hot air can release.
- Do not operate the appliance with wet hands or when it has contact with water.
- Do not use the appliance as a work surface or as a storage surface.



WARNING! Risk of fire and explosion

- Fats and oil when heated can release flammable vapours. Keep flames or heated objects away from fats and oils when you cook with them.
- The vapours that very hot oil releases can cause spontaneous combustion.
- Used oil, that can contain food remnants, can cause fire at a lower temperature than oil used for the first time.
- Do not put flammable products or items that are wet with flammable products in, near or on the appliance.
- Do not let sparks or open flames to come in contact with the appliance when you open the door.
- Open the appliance door carefully. The use of ingredients with alcohol can cause a mixture of alcohol and air.



WARNING! Risk of damage to the appliance.

- To prevent damage or discoloration to the enamel:

- do not put ovenware or other objects in the appliance directly on the bottom.
- do not put aluminium foil on the appliance or directly on the bottom of cavity.
- do not put water directly into the hot appliance.
- do not keep moist dishes and food in the appliance after you finish the cooking.
- be careful when you remove or install the accessories.

- Discoloration of the enamel or stainless steel has no effect on the performance of the appliance.
- Use a deep pan for moist cakes. Fruit juices cause stains that can be permanent.
- Do not keep hot cookware on the control panel.
- Do not let cookware boil dry.
- Be careful not to let objects or cookware fall on the appliance. The surface can be damaged.
- Do not activate the cooking zones with empty cookware or without cookware.
- Cookware made of cast iron, aluminium or with a damaged bottom can cause scratches. Always lift these objects up when you have to move them on the cooking surface.
- Provide good ventilation in the room where the appliance is installed.
- Use only stable cookware with the correct shape and diameter larger than the dimensions of the burners.
- Make sure the flame does not go out when you quickly turn the knob from the maximum to the minimum position.
- Use only the accessories supplied with the appliance.
- Do not install a flame diffuser on the burner.
- This appliance is for cooking purposes only. It must not be used for other purposes, for example room heating.

CARE AND CLEANING



WARNING! Risk of injury, fire, or damage to the appliance.

- Before maintenance, deactivate the appliance. Disconnect the mains plug from the mains socket.
- Make sure the appliance is cold. There is the risk that the glass panels can break.
- Replace immediately the door glass panels when they are damaged. Contact the Authorised Service Centre.
- Be careful when you remove the door from the appliance. The door is heavy!
- Fat and food remaining in the appliance can cause fire.

- Clean regularly the appliance to prevent the deterioration of the surface material.
- Make sure the cavity and the door are wiped dry after each use. Steam produced during the operation of the appliance condensates on cavity walls and can cause corrosion. To decrease the condensation operate the appliance for 10 minutes before cooking.
- Clean the appliance with a moist soft cloth. Only use neutral detergents. Do not use any abrasive products, abrasive cleaning pads, solvents or metal objects.
- If you use an oven spray, obey the safety instructions on the packaging.
- Do not clean the catalytic enamel (if applicable) with any kind of detergent.
- Do not clean the burners in the dishwasher.

LID

- Do not change the specification of the lid.
- Clean the lid regularly.
- Do not open the lid, when there are spills on the surface.
- Before you close the lid turn all burners off.
- Do not close the lid until the hob and oven are completely cold.
- Glass lid can shatter, when heated (if applicable).



INTERNAL LIGHTING



WARNING! Risk of electric shock.

- The type of light bulb or halogen lamp used for this appliance is for household appliances only. Do not use it for house lighting.
- Before replacing the lamp, disconnect the appliance from the power supply.
- Only use lamps with the same specifications.

SERVICE

- To repair the appliance contact the Authorised Service Centre.
- Use original spare parts only.

DISPOSAL



WARNING! Risk of injury or suffocation.

- Contact your municipal authority for information on how to discard the appliance correctly.
- Disconnect the appliance from the mains supply.
- Cut off the mains electrical cable close to the appliance and dispose of it.
- Remove the door catch to prevent children or pets from becoming trapped in the appliance.
- Flat the external gas pipes.

PRODUCT DESCRIPTION

GENERAL OVERVIEW

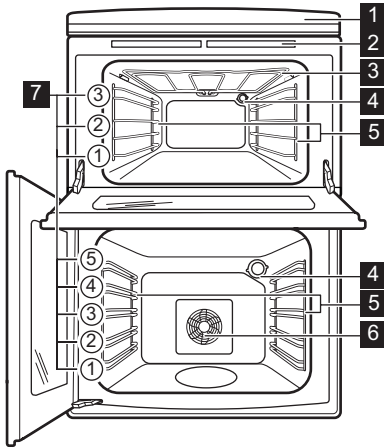

- 1 Control panel and hob
- 2 Air vents for the cooling fan
- 3 Heating element
- 4 Lamp
- 5 Shelf support, removable
- 6 Fan
- 7 Shelf positions

COOKING SURFACE LAYOUT

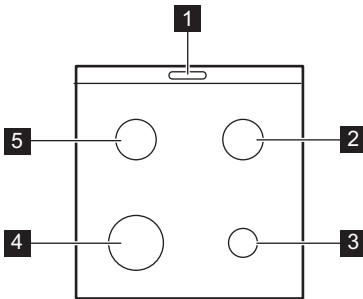

- 1 Steam outlet - number and position depend on the model
- 2 Semi-rapid burner
- 3 Auxiliary burner
- 4 Rapid burner
- 5 Semi-rapid burner

COOKER CONTROL PANEL

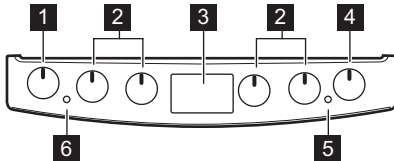

- 1 Knob for the top oven
- 2 Knobs for the hob
- 3 Display
- 4 Knob for the main oven
- 5 Temperature indicator for the main oven
- 6 Temperature indicator for the top oven

ACCESSORIES

- **Wire shelf**
For cookware, cake tins, roasts.
- **Grill- / Roasting pan**

- To bake and roast or as pan to collect fat.
- **Trivet**
For roasting and grilling.



Use the trivet only with the Grill- / roasting pan.

BEFORE FIRST USE



WARNING! Refer to Safety chapters.

INITIAL CLEANING

Remove all accessories and removable shelf supports from the oven.

Refer to "Care and cleaning" chapter.

Clean the oven and the accessories before the first use.

Put the accessories and the removable shelf supports back to their initial position.

SETTING THE TIME

You must set the time before you operate the oven.



Only the top oven works without the set time.

The flashes when you connect the appliance to the electrical supply, when there was a power cut or when the timer is not set.

Press the or to set the correct time.

After approximately five seconds, the flashing stops and the display shows the time of day you set.

HOB - DAILY USE



WARNING! Refer to Safety chapters.

IGNITION OF THE HOB BURNERS



Always light the burner before you put on the cookware.



WARNING! Be very careful when you use open fire in the kitchen environment. The manufacturer declines any responsibility in case of the flame misuse.

1. Turn the knob for the hob to the position and push it down. When you push the knob, the spark generator activates automatically.

CHANGING THE TIME



You cannot change the time of day if the Duration or End function operates.

Press again and again until the indicator for the Time of Day function flashes.

To set a new time, refer to "Setting the time".

PREHEATING

Preheat the empty appliance before first use.



Preheat the two ovens. Heat up one oven at a time.

1. Set the maximum temperature.
2. Let the appliance operate for 1 hour.
3. Set the function .
4. Let the appliance operate for 15 minutes.

Accessories can become hotter than usual. The appliance can emit an odour and smoke. This is normal. Make sure that the airflow is sufficient.

2. Keep the knob for the hob pushed for equal or less than 10 seconds to let the thermocouple warm up. If not, the gas supply is interrupted.
3. Adjust the flame after it is regular.



WARNING! Do not keep the knob pushed for more than 10 seconds. If the burner does not light after 10 seconds, release the knob, turn it into the off position and try to light the burner again after minimum 1 minute.



If after some tries the burner does not light, check if the crown and its cap are in the correct position.

i In the absence of electricity you can ignite the burner without an electrical device. In this case approach the burner with a flame, push the relevant knob down and turn it to maximum position. Keep the knob pushed for equal or less than 10 seconds to let the thermocouple warm up.

i If the burner accidentally goes out, turn the knob to the off position and try to light the burner again after minimum 1 minute.

i The spark generator can start automatically when you switch on the mains, after installation or a power cut. It is normal.

BURNER OVERVIEW

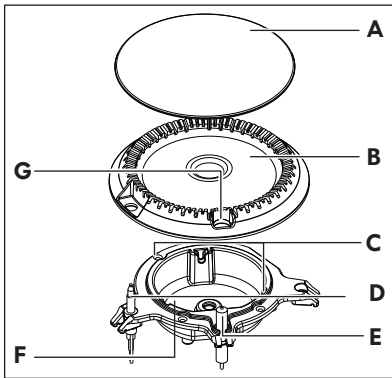

- A. Burner cap
- B. Burner crown
- C. Slots
- D. Thermocouple
- E. Ignition candle
- F. Burner body
- G. Hole for the ignition candle

REPLACING BURNER PARTS

1. Put carefully the burner crown on the burner body. Let the crown fall freely onto the body. Do not use force.
Make sure that the hole in the crown is above the ignition candle.
Make sure that the location pegs are in the slots in the burner body.
Make sure that you can move the crown a small distance from side to side.
2. Put the burner cap centrally on top of the crown.
Make sure that the cap is correctly installed, with the enamel side up and you can move the cap from side to side and front to back.
3. Light the burner.
If the burner does not ignite, adjust the crown and cap again.

TURNING THE BURNER OFF

To put the flame out, turn the knob to the off position **0**.



WARNING! Always turn the flame down or switch it off before you remove the pans from the burner.

LID SAFETY DEVICE

Lid has safety device, which cuts off the gas supply for the hob. Closing the lid activates the safety device.



WARNING! Always use the knob for the hob to switch off a burner. Do not use the lid as a cut-off device.

HOB - HINTS AND TIPS



WARNING! Refer to Safety chapters.

COOKWARE



WARNING! Do not put unstable or damaged pots on the burner to prevent spills and injuries.



CAUTION! Make sure that pot handles are not above the front edge of the cooktop.



CAUTION! Make sure that the pots are placed centrally on the burner in order to get the maximum stability and a lower gas consumption.

HOB - CARE AND CLEANING



WARNING! Refer to Safety chapters.

GENERAL INFORMATION

- Clean the hob after each use.
- Always use cookware with a clean base.
- Scratches or dark stains on the surface have no effect on how the hob operates.
- Use a special cleaner suitable for the surface of the hob.
- Wash stainless steel parts with water, and then dry them with a soft cloth.

PAN SUPPORTS



The pan supports are not resistant to washing in a dishwasher. They must be washed by hand.

1. Remove the pan supports to easily clean the hob.



Be very careful when you replace the pan supports to prevent the hob top from damage.

DIAMETERS OF COOKWARE



WARNING! Use cookware with diameters applicable to the size of burners.

| Burner | Diameter of cookware (mm) |
|------------|-------------------------------|
| Rapid | 180 - 240 / 260 ¹⁾ |
| Semi-rapid | 120 - 220 / 240 |
| Auxiliary | 80 - 160 |

1) When a single pot is used on the hob

2. After you clean the pan supports, make sure that they are in correct positions.
3. For the burner to operate correctly, make sure that the arms of the pan supports are aligned with the centre of the burner.

CLEANING THE HOB

- **Remove immediately:** melted plastic, plastic foil, sugar and food with sugar, otherwise, the dirt can cause damage to the hob. Take care to avoid burns.
- **Remove when the hob is sufficiently cool:** limescale rings, water rings, fat stains, shiny metallic discoloration. Clean the hob with a moist cloth and a non-abrasive detergent. After cleaning, wipe the hob dry with a soft cloth.

CLEANING THE SPARK PLUG

This feature is obtained through a ceramic ignition candle with a metal electrode. Keep these components well clean to prevent difficult lighting and check that the burner crown holes are not obstructed.

OVEN - DAILY USE



WARNING! Refer to Safety chapters.

TOP OVEN FUNCTIONS

| Symbol | Oven function | Application |
|-----------|----------------------|---|
| 0 | Off position | The oven is off. |
| | Oven Lamp | To turn on the lamp without a cooking function. |
| 100 - 250 | Conventional Cooking | To bake and roast food on one shelf position. |
| | Dual Circuit Grill | To grill flat food in medium quantities in the middle of the shelf. To make toasts. |
| | Full Grill | To grill flat food and to toast bread. |

MAIN OVEN FUNCTIONS

| Symbol | Oven function | Application |
|-----------|---------------|--|
| 0 | Off position | The oven is off. |
| | Oven Lamp | To turn on the lamp without a cooking function. |
| | Defrost | To defrost food (vegetables and fruit). The defrosting time depends on the amount and size of the frozen food. |
| 100 - 250 | Thermaflow® | To bake on up to two shelf positions at the same time and to dry food. |

ACTIVATING AND DEACTIVATING THE TOP / MAIN OVEN



It depends on the model if your appliance has knob symbols, indicators or lamps:

- The indicator comes on when the oven heats up.
- The lamp comes on when the oven operates.
- The symbol shows whether the knob controls one of the cooking zones, the oven functions or the temperature.

1. Turn the knob for the top / main oven functions to select an oven function.
2. To deactivate the oven turn the knob for the top / main oven functions to the off position.

COOLING FAN

When the oven operates, the cooling fan turns on automatically to keep the surfaces of the oven cool. If you turn off the oven, the cooling fan can continue to operate until the oven cools down.

INSERTING THE OVEN ACCESSORIES

Deep pan:

Push the deep pan between the guide bars of the shelf support.

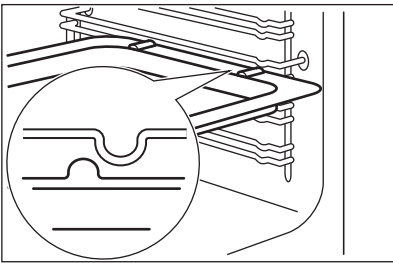

Wire shelf and the deep pan together:

Push the deep pan between the guide bars of the shelf support and the wire shelf on the guide bars above.

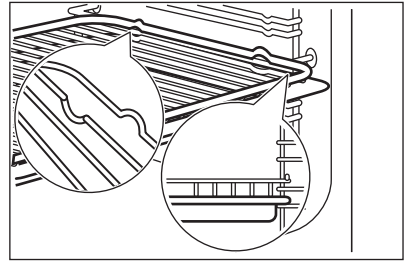

- All accessories have small indentations at the top of the right and left side to increase safety. The indentations are also anti-tip devices.
- The high rim around the shelf is a device which prevents cookware from slipping.

TRIVET AND GRILL- / ROASTING PAN



WARNING! Be careful when you remove the accessories from a hot oven. There is a risk of burns.

You can use the trivet to roast larger pieces of meat or poultry on one shelf position.

1. Put the trivet into the deep pan so that the supports of the wire shelf point up.

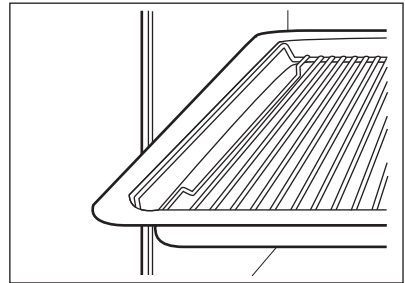

2. Put the deep pan into the oven on the necessary shelf position.

You can use the trivet to grill flat dishes in large quantities and to toast.

1. Put the trivet into the deep pan so that the supports of the wire shelf point down.

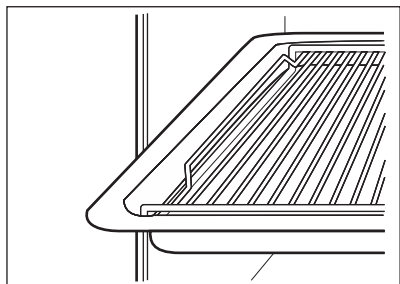

2. Put the deep pan into the oven on the necessary shelf position.

OVEN - CLOCK FUNCTIONS

DISPLAY



The display works only with the main oven.

- A. Clock functions
- B. Timer
- C. Clock function

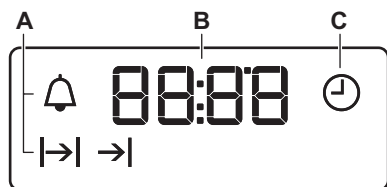



BUTTONS





| Button | Function | Description |
|--------|----------|--------------------------|
| — | MINUS | To set the time. |
| ⌚ | CLOCK | To set a clock function. |
| + | PLUS | To set the time. |

CLOCK FUNCTIONS TABLE

| Clock function | Application |
|----------------|---|
| ⌚ | TIME OF DAY To set, change or check the time of day. |
| → | DURATION To set how long the appliance operates. |
| → | END To set when the appliance deactivates. |

| Clock function | | Application |
|--|---------------|--|
|   | TIME DELAY | To combine DURATION and END function. |
|  | MINUTE MINDER | To set countdown time. This function has no effect on the operation of the appliance. You can set the MINUTE MINDER at any time, also when the appliance is off. |

SETTING THE DURATION





1. Set an oven function and temperature.
2. Press  again and again until  starts to flash.
3. Press  or  to set the DURATION time.

The display shows .

4. When the time ends,  flashes and an acoustic signal sounds. The appliance deactivates automatically.
5. Press any button to stop the acoustic signal.
6. Turn the knob for the oven functions to the off position.

 DURATION works only for the main oven.

SETTING THE END

1. Set an oven function and temperature.
2. Press  again and again until  starts to flash.
3. Press  or  to set the time.









The display shows .

4. When the time ends,  flashes and an acoustic signal sounds. The appliance deactivates automatically.
5. Press any button to stop the signal.
6. Turn the knob for the oven functions to the off position.

 The function works only for the main oven.

SETTING THE TIME DELAY

1. Set an oven function and temperature.





2. Press  again and again until  starts to flash.
3. Press  or  to set the time for DURATION.
4. Press .
5. Press  or  to set the time for END.
6. Press  to confirm.

Appliance turns on automatically later on, works for the set DURATION time and stops at the set END time. At the set time an acoustic signal sounds.



7. The appliance deactivates automatically. Press any button to stop the signal.
8. Turn the knob for the oven functions to the off position.

 TIME DELAY works only for the main oven.

SETTING THE MINUTE MINDER

1. Press  again and again until  starts to flash.
2. Press  or  to set the necessary time. The Minute Minder starts automatically after 5 seconds.
3. When the set time ends, an acoustic signal sounds. Press any button to stop the acoustic signal.
4. Turn the knob for the oven functions to the off position.

CANCELLING THE CLOCK FUNCTIONS

1. Press the  again and again until the necessary function indicator starts to flash.
2. Press and hold .

The clock function goes out after some seconds.

OVEN - HINTS AND TIPS



WARNING! Refer to Safety chapters.



The temperature and baking times in the tables are guidelines only. They depend on the recipes and the quality and quantity of the ingredients used.

TOP OVEN

The top oven is the smaller of the two ovens. It has 3 shelf positions. Use it to cook smaller quantities of food. It gives especially good results when used to cook fruitcakes, sweets and savoury flants or quiche.

MAIN OVEN

The main oven is particularly suitable for cooking larger quantities of food.

TIPS ON BAKING

| Baking results | Possible cause | Remedy |
|---|--|--|
| The bottom of the cake is not baked sufficiently. | The shelf position is incorrect. | Put the cake on a lower shelf. |
| The cake sinks and becomes soggy or streaky. | The oven temperature is too high. | Next time set slightly lower oven temperature. |
| | The baking time is too short. | Next time set a longer baking time and lower oven temperature. |
| The cake is too dry. | The oven temperature is too low. | Next time set higher oven temperature. |
| | The baking time is too long. | Next time set shorter baking time. |
| The cake bakes unevenly. | The oven temperature is too high and the baking time is too short. | Set lower oven temperature and longer baking time. |
| | The cake batter is not evenly distributed. | Next time spread the cake batter evenly on the baking tray. |
| The cake is not ready in the baking time specified in a recipe. | The oven temperature is too low. | Next time set a slightly higher oven temperature. |

BAKING

Use the lower temperature the first time.

You can extend baking times by 10 – 15 minutes if you bake cakes on more than one shelf position.

Cakes and pastries at different heights do not always brown equally. There is no need to change the temperature setting if an unequal browning occurs. The differences equalize during baking.

Trays in the oven can twist during baking. When the trays become cold again, the distortions disappear.

CONVENTIONAL BAKING - TOP OVEN

| Food | Temperature (°C) | Time (min) | Shelf position |
|-----------------------------------|-------------------------------------|------------|----------------|
| Biscuits | 170 - 190 | 10 - 20 | 2 |
| Bread | 200 - 220 | 30 - 35 | 2 |
| Bread rolls / buns | 200 - 220 | 10 - 15 | 2 |
| Cakes: Victoria Sandwich | 160 - 170 | 18 - 25 | 2 |
| Cakes: Madeira | 140 - 150 | 75 - 90 | 2 |
| Cakes: Rich Fruit | 140 - 150 | 120 - 150 | 2 |
| Cakes: Gingerbread | 140 - 150 | 80 - 90 | 2 |
| Cakes: Meringues | 90 - 100 | 150 - 180 | 2 |
| Cakes: Flapjack | 160 - 170 | 25 - 30 | 2 |
| Casseroles: Beef / Lamb | 160 - 170 | 150 - 180 | 2 |
| Casseroles: Chicken | 160 - 180 | 80 - 90 | 2 |
| Convenience Foods | Follow manufacturer's instructions. | | 2 |
| Fish | 170 - 190 | 20 - 30 | 2 |
| Fish Pie (Potato Topped) | 190 - 200 | 20 - 30 | 2 |
| Fruit Pies, Crumbles | 190 - 200 | 30 - 50 | 2 |
| Milk Puddings | 150 - 170 | 90 - 120 | 2 |
| Pasta Lasagne etc. | 170 - 180 | 40 - 50 | 2 |
| Pastry: Choux | 180 - 190 | 30 - 40 | 2 |
| Pastry: Eclairs, Profiteroles | 180 - 190 | 30 - 40 | 2 |
| Pastry: Flaky / Puff Pies | 210 - 220 | 30 - 40 | 2 |
| Shortcrusts: Mince Pies | 190 - 200 | 15 - 20 | 2 |
| Shortcrusts: Meat Pies | 190 - 210 | 25 - 35 | 2 |
| Shortcrusts: Quiche, Tarts, Flans | 180 - 200 | 25 - 50 | 2 |
| Scones | 220 - 230 | 8 - 12 | 3 |
| Shepard's Pie | 190 - 200 | 30 - 40 | 2 |
| Souffles | 170 - 180 | 20 - 30 | 2 |
| Vegetables: Baked Jacket Potatos | 180 - 190 | 60 - 90 | 2 |
| Vegetables: Roast Potatos | 180 - 190 | 60 - 90 | 2 |
| Yorkshire Pudding Large | 220 - 210 | 25 - 40 | 2 |
| Yorkshire Pudding Individual | 210 - 220 | 15 - 25 | 2 |
| Roasting Meat, Poultry | Refer to the Roasting table. | | 2 |

THERMAFLOW® BAKING - MAIN OVEN



Shelf positions are not critical but ensure that the oven accessories are evenly spaced when more than one is used.

| Food | Temperature (°C) | Time (min) | Shelf position |
|-------------------------|---|------------------------------|----------------|
| Biscuits | 180 - 190 | 10 - 20 | 1 - 3 |
| Bread | 190 - 210 | 30 - 35 | 2 |
| Cakes: Small & Queen | 150 - 170 | 18 - 25 | 1 - 3 |
| Cakes: Sponges | 160 - 170 | 20 - 25 | 3 |
| Cakes: Madeira | 140 - 160 | 60 - 80 | 3 |
| Cakes: Rich Fruit | 130 - 140 | 120 - 150 | 3 |
| Cakes: Christmas | 130 - 140 | 180 - 270 | 3 |
| Cakes: Apple Pie | 160 - 170 | 50 - 60 | 3 |
| - Shortbread | 130 - 150 | 45 - 60 | 1 - 3 |
| Fish | 160 - 180 | 30 - 40 | 3 |
| Fruit Pies, Crumbles | 170 - 180 | 30 - 50 | 3 |
| Milk Puddings | 140 - 160 | 60 - 90 | 3 |
| Pastry: Choux | 180 - 190 | 30 - 40 | 3 |
| Pastry: Shortcrust | 180 - 190 | 25 - 35 | 3 |
| Pastry: Flaky | 180 - 190 | 30 - 40 | 3 |
| Pastry: Puff | Follow manufacturer's instructions. Reduce the temperature for Fan oven by 20 °C. | | 3 |
| Plate Tarts | 180 - 190 | 25 - 45 | 3 |
| Quiches / Flans | 170 - 180 | 25 - 45 | 3 |
| Scones | 210 - 230 | 8 - 12 | 1 - 3 |
| Roasting: Meat, Poultry | 160 - 180 | Refer to the Roasting table. | 2 |

ROASTING

Use heat-resistant ovenware.

Roast lean meat covered.

Roast large meat joints directly in the tray or on the wire shelf placed above the tray.

Put some water in the tray to prevent dripping fat from burning.

Turn the roast after 1/2 - 2/3 of the cooking time.

Baste meat joints with their own juice several times during roasting.

THERMAFLOW® - MAIN OVEN

Roasting

| Food | Temperature (°C) | Time (min) |
|-------------------|------------------|--|
| Beef / Beef boned | 170 - 190 | 20 - 35 minutes per 0.5 kg (1 lb) and 20 - 30 minutes over |
| Mutton / Lamb | 170 - 190 | 20 - 35 minutes per 0.5 kg (1 lb) and 25 - 35 minutes over |
| Pork / Veal / Ham | 170 - 190 | 30 - 40 minutes per 0.5 kg (1 lb) and 30 - 40 minutes over |
| Chicken | 180 - 200 | 20 - 25 minutes per 0.5 kg (1 lb) and 20 minutes over |
| Turkey / Goose | 170 - 190 | 15 - 20 minutes per 0.5 kg (1 lb) up to 3.5 kg (7 lb) then 10 minutes per 0.5 kg (1 lb) over 3.5 kg (7 lb) |
| Duck | 180 - 200 | 25 - 35 minutes per 0.5 kg (1 lb) and 25 - 30 minutes over |
| Pheasant | 170 - 190 | 35 - 40 minutes per 0.5 kg (1 lb) and 35 - 40 minutes over |
| Rabbit | 170 - 190 | 20 minutes per 0.5 kg (1 lb) and 20 minutes over |

GRILLING IN GENERAL



WARNING! Always grill with the oven door closed.

- **Always grill with the maximum temperature setting.**
- Set the shelf into the shelf position as recommended in the grilling table.
- Always set the deep pan to collect the fat into the first shelf position.

- Grill only flat pieces of meat or fish.

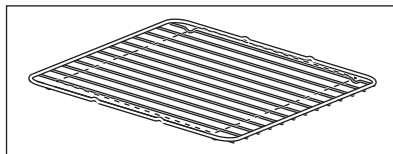

The grilling area is set in centre of the shelf.

DUAL GRILL - TOP OVEN

| Food | Time (min) | Shelf position |
|--------------------------------|------------|----------------|
| Bacon Rashers | 5 - 6 | 3 |
| Chicken Joints | 20 - 40 | 2 |
| Chops - Lamb | 15 - 25 | 2 - 3 |
| Chops - Pork | 20 - 25 | 2 - 3 |
| Fish - Whole / Trout / Makarel | 10 - 12 | 2 |
| Filletts - Plaice / Cod | 4 - 6 | 2 |
| Kebabs | 12 - 18 | 2 - 3 |

| Food | Time (min) | Shelf position |
|----------------------|------------|----------------|
| Kidneys - Lamb / Pig | 6 - 10 | 2 - 3 |
| Sausages | 20 - 30 | 3 |
| Steaks: Rare | 4 - 6 | 3 |
| Steaks: Medium | 6 - 8 | 3 |
| Steaks: Well Done | 12 - 15 | 3 |

DEFROST

- Remove the food packaging. Put the food on a plate.
 - Do not cover it with a bowl or a plate. This can extend the defrost time.
- Use the first shelf position. The one on the bottom.

INFORMATION FOR TEST INSTITUTES

Main oven

| Food | Function | Temperature (°C) | Time (min) | Accessories | Shelf position |
|---|----------------------|------------------|------------|-------------|----------------|
| Small cakes (20 small cakes per tray) | Conventional Cooking | 170 | 25 - 35 | Tray | 3 |
| Small cakes (20 small cakes per tray) | Thermaflow® | 150 | 25 - 35 | Tray | 3 |
| Small cakes (20 small cakes per tray) | Thermaflow® | 150 | 25 - 35 | Tray | 1 / 4 |
| Apple pie, 2 tins (ø 20 cm) on the grid, diagonally shifted | Conventional Cooking | 200 | 80 - 100 | Grid | 1 |
| Apple pie, 2 tins (ø 20 cm) on the grid, diagonally shifted | Thermaflow® | 170 | 80 - 100 | Grid | 2 |
| Apple pie, 2 tins (ø 20 cm) on the grid, diagonally shifted ¹⁾ | Plus Steam | 160 | 70 - 80 | Tray | 2 |
| Fatless sponge cake, 1 tin (ø 26 cm) on the grid | Conventional Cooking | 200 | 25 - 35 | Grid | 2 |
| Fatless sponge cake, 1 tin (ø 26 cm) on the grid | Thermaflow® | 170 | 25 - 35 | Grid | 2 |

| Food | Function | Temperature (°C) | Time (min) | Accessories | Shelf position |
|--|----------------------|------------------|------------|-------------|----------------|
| Fatless sponge cake, 1 tin (ø 26 cm) on the grid | Thermaflow® | 170 | 30 - 40 | Grid | 1 / 4 |
| Shortbread/Pastry strip | Conventional Cooking | 160 | 20 - 30 | Tray | 3 |
| Shortbread/Pastry strip | Thermaflow® | 140 | 20 - 30 | Tray | 3 |
| Shortbread/Pastry strip | Thermaflow® | 140 | 15 - 25 | Tray | 1 / 4 |

1) Add 150 ml of water to the cavity embossment.

Top oven

| Food | Function | Temperature (°C) | Time (min) | Accessories | Shelf position |
|---|----------------------|------------------|---|---------------------|----------------|
| Small cakes (20 small cakes per tray) | Conventional Cooking | 150 | 25 - 35 | Tray | 2 |
| Apple pie, 2 tins (ø 20 cm) on the grid, diagonally shifted | Conventional Cooking | 170 | 60 - 80 | Grid | 1 |
| Fatless sponge cake, 1 tin (ø 26 cm) on the grid | Conventional Cooking | 170 | 20 - 30 | Grid | 2 |
| Shortbread/Pastry strip | Conventional Cooking | 140 | 15 - 25 | Tray | 2 |
| Toast | Full Grill | - | 3 - 8 | Grid | 2 |
| Beef burger | Dual Circuit Grill | - | 15 - 25 (first side) 10 - 20 (second side) | Grid / Roasting pan | 2 |

OVEN - CARE AND CLEANING



WARNING! Refer to Safety chapters.

NOTES ON CLEANING

Agents

Clean the front of the oven with a soft cloth with warm water and a mild cleaning agent.

To clean metal surfaces, use a dedicated cleaning agent.

Clean stubborn stains with a special oven cleaner. Do not apply oven cleaner on the catalytic surfaces.

Everyday Use

Clean the oven cavity after each use. Fat accumulation or other food remains may cause a fire. The risk is higher for the grill pan.

Wipe off moisture from the cavity after each use.

Accessories

Clean all accessories after each use and let them dry. Use a soft cloth with warm water and a cleaning agent. Do not clean the accessories in the dishwasher.

Do not clean the non-stick accessories using aggressive agents, sharp-edged objects or in a dishwasher

STAINLESS STEEL OR ALUMINIUM OVENS

Clean the oven door with a damp cloth or sponge only. Dry it with a soft cloth.

Do not use steel wool, acids or abrasive materials as they can damage the oven surface. Clean the oven control panel with the same precautions.

CATALYTIC CLEANING



CAUTION! Do not clean the catalytic surface with oven sprays, abrasive cleaning agents, soap or other cleaning agents. This will damage the catalytic surface.



Spots or discolouration of the catalytic surface have no effect on catalytic properties.



WARNING! Keep children away when you clean the oven at a high temperature. The oven surface becomes very hot and there is a risk of burns.



CAUTION! Always turn the oven light on while using the catalytic cleaning (if applicable).



Before activating the catalytic cleaning remove all the accessories from the oven.

The walls with a catalytic coating are self-cleaning. They absorb fat which collects on the walls while the appliance operates.

To support the self-cleaning procedure, heat the empty oven on a regular basis.

1. Clean the oven floor with warm water and washing up liquid, then dry it.
2. Set the oven temperature to 250 °C and let the oven operate for 1 hour.
3. When the appliance is cool, clean it with a soft and moist sponge.

REMOVING THE SHELF SUPPORTS

To clean the oven, remove the shelf supports.

1. Pull the front of the shelf support away from the side wall.

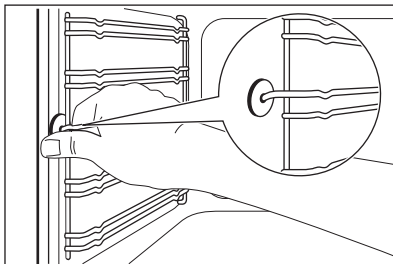

2. Pull the rear end of the shelf support away from the side wall and remove it.

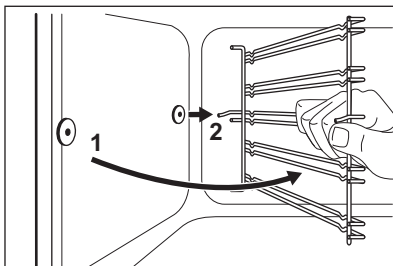

Install the shelf supports in the opposite sequence.



CAUTION! Make sure that the longer fixing wire is in the front. The ends of the two wires must point to the rear. Incorrect installation can cause damage to the enamel.

REMOVING AND CLEANING THE DOOR GLASSES - TOP OVEN



The door glass in your product can be different in type and shape from the examples you see in the image. The number of glasses can also be different.

1. Open the door.
2. Hold the door trim on the top edge of the door at the two sides and push inwards to release the clip seal.

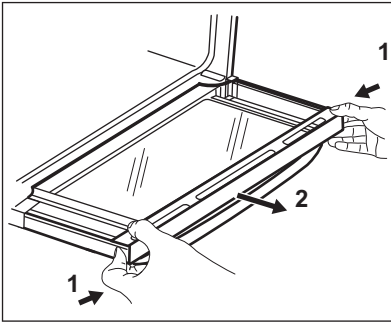

2. Pull up the trim.
3. Remove the glass panels.



To replace the glass panels, do the same steps in reverse. Before you lower the trim, attach the A trim part to the door. Refer to the image.

REPLACING THE LAMP



WARNING! Risk of electric shock. The lamp can be hot.

1. Turn off the oven.
Wait until the oven is cooled down.
2. Disconnect the oven from the mains.
3. Put a cloth on the bottom of the cavity.

The back lamp



The lamp glass cover is at the back of the cavity.

1. Turn the lamp glass cover counterclockwise to remove it.
2. Clean the glass cover.
3. Replace the oven lamp with a suitable 300 °C heat-resistant oven lamp. Use the same oven lamp type.
4. Install the glass cover.

3. Pull the door trim to the front to remove it.
 4. Remove the glass panels.
- To install the panels, do the same steps in reverse.

REMOVING AND CLEANING THE DOOR GLASSES - MAIN OVEN



The door glass in your product can be different in type and shape from the example you see in the image. The number of glasses can also be different.

1. Push the door trim at one side to remove it.

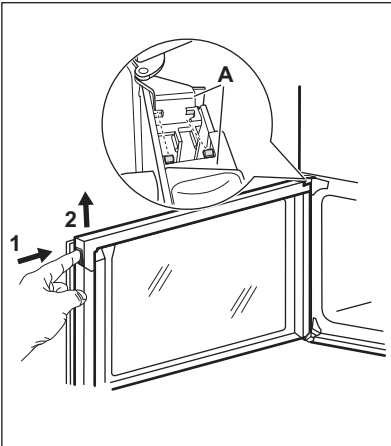

TROUBLESHOOTING



WARNING! Refer to Safety chapters.

WHAT TO DO IF...

| Problem | Possible cause | Remedy |
|--|--|---|
| You cannot activate the appliance. | The appliance is not connected to an electrical supply or it is connected incorrectly. | Check if the appliance is correctly connected to the electrical supply. |
| You cannot activate the appliance. | The fuse is blown. | Make sure that the fuse is the cause of the malfunction. If the fuse is blown again and again, contact a qualified electrician. |
| The burners do not work. | There is no gas supply. | Check the gas connection. |
| There is no spark when you try to activate the spark generator. | Burner cap and crown are placed incorrectly. | Place the burner cap and crown correctly. |
| The flame extinguishes immediately after ignition. | Thermocouple is not heated up sufficiently. | After lighting the flame, keep the knob pushed for equal or less than 10 seconds. |
| The flame ring is uneven. | Burner crown is blocked with food residues. | Make sure that the injector is not blocked and the burner crown is clean. |
| The oven does not heat up. | The oven is deactivated. | Activate the oven. |
| The oven does not heat up. | The clock is not set. | Set the clock. |
| The oven does not heat up. | The necessary settings are not set. | Make sure that the settings are correct. |
| The lamp does not operate. | The lamp is defective. | Replace the lamp. |
| The display shows "12.00". | There was a power cut. | Reset the clock. |
| Steam and condensation settle on the food and in the cavity of the oven. | You left the dish in the oven for too long. | Do not leave the dishes in the oven for longer than 15 - 20 minutes after the cooking process ends. |

SERVICE DATA

If you cannot find a solution to the problem yourself, contact your dealer or an Authorised Service Centre.

The necessary data for the service centre is on the rating plate. The rating plate is on the front frame of

the oven cavity. Do not remove the rating plate from the oven cavity.

We recommend that you write the data here:

| | |
|----------------------|-------|
| Model (MOD.) | |
| Product number (PNC) | |
| Serial number (S.N.) | |

INSTALLATION



WARNING! Refer to Safety chapters.

TECHNICAL DATA

Dimensions

| | |
|--------|--------------|
| Height | 894 - 912 mm |
| Width | 600 mm |
| Depth | 609 mm |

LOCATION OF THE APPLIANCE

You can install your freestanding appliance with cabinets on one or two sides and in the corner. For the minimal distances of fitting check the table.

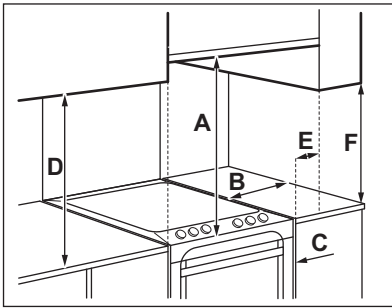

Minimum distances

| Dimension | mm |
|-----------|-----|
| A | 650 |
| B | 450 |

GAS BURNERS

| BURNER | NORMAL POWER kW | Natural Gas | |
|-----------|-----------------|------------------------|-------|
| | | INJECTOR MARK 1/100 mm | Btu/h |
| Auxiliary | 1 | 70 | 3412 |

| Dimension | mm |
|-----------|---------------|
| C | 2 |
| D | 400 |
| E | 150 |
| F | less than 400 |

LEVELLING OF THE APPLIANCE

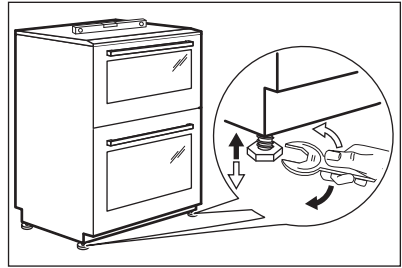

Use small feet on the bottom of appliance to set the appliance top surface level with other surfaces.

OTHER TECHNICAL DATA



WARNING! These instructions are only valid in the countries whose symbols appear on this booklet's cover.

| | |
|---------------|------------------|
| Gas category: | I2H |
| Gas supply: | G20 (2H) 20 mbar |
| Voltage: | 220-240 V |
| Frequency: | 50 Hz |

| BURNER | NORMAL POWER kW | Natural Gas | |
|------------|-----------------|------------------------|-------|
| | | INJECTOR MARK 1/100 mm | Btu/h |
| Semi-rapid | 1.9 | 96 | 6483 |
| Rapid | 3 | 119 | 10236 |

GAS CONNECTION

Use a flexible pipe in compliance with the regulation in force. Make sure they do not come in touch with mobile parts and are not squeezed.



WARNING! Only a qualified and competent person can do the gas installation.

Before you connect to gas, disconnect the appliance from the electricity supply or switch off the fuse in the fuse box. Close the primary valve of the gas supply.



Supply piping should not be less than R3/8. Connection is made to the Rc 1/2 (1/2 " B.S.P.) female threaded. The entry pipe is located just below the hob level on the rear left hand side of the appliance.

The gas supply ramp is on the rear side of the appliance.



WARNING! Only liquid sealants can be used when the inlet gas pipe is fitted i.e.: do not use the P.T.F.E. sealant tape.

When the installation is complete, carry out a gas tightness test and make sure that the seal of each pipe fitting does not leak.



Use flexible tubing, which comply with the BS.669 current edition.

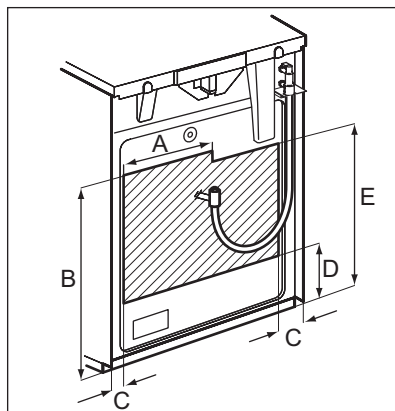

WARNING! The gas bayonet connector must be in the marked area.

| Dimension | mm |
|-----------|-----|
| A | 250 |
| B | 680 |
| C | 50 |
| D | 250 |
| E | 580 |

PRESSURE TEST

The Rapid injector is used as a pressure test point.

1. Connect the pressure gauge to the Rapid injector.
2. Examine the supply pressure by turning the Rapid burner and one other burner fully on, and lighting them. The pressure must be 20 mbar for Natural Gas.
3. Turn the taps off and disconnect the pressure gauge.

4. Make sure that all burners work correctly.

CHECKING THE HOB BURNERS

1. Lift the lid.
2. Put on the burner crowns and caps. Make sure that they are correctly seated.
3. Put on the pan supports.
4. Light one of the hob burners.
To light the hob burner refer to the "Ignition of the hob burners".
Check if the flame is regular.
Check each of the burners.
5. Turn the knob for the hob to the off position.

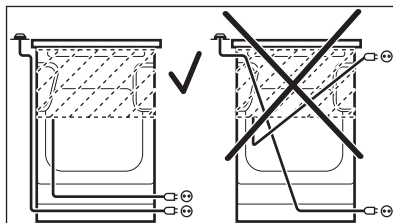

CHECKING THE LID SAFETY DEVICE

1. Lift the lid.
2. Light one of the hob burners.
To light the hob burner refer to the "Ignition of the hob burners".
3. Close the lid. There should be no gas supply to the hob burners. The burner goes out.
4. Turn the knob to the off position and lift the lid.
The gas supply should be restored to the hob burners, when you turn the knob on.

ELECTRICAL INSTALLATION



WARNING! The manufacturer is not responsible if you do not follow the safety precautions from Safety chapters.

This appliance is supplied without a main plug or a main cable.

Applicable types of cables for different phases:

| Phase | Min. size cable |
|----------------|-----------------------|
| 1 | 3x2.5 mm ² |
| 3 with neutral | 5x1.0 mm ² |



WARNING! The power cable must not touch the part of the appliance shaded in the illustration.

COVERING TERMINAL BOARD

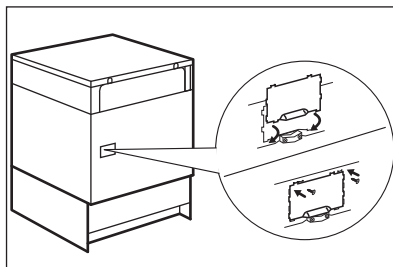

- The recommended cross-section area is six square millimetres (6 mm²).
- When you refit the mains terminal cover, make sure that the lower tabs are located inside the bottom edge of the aperture, before you fix the two screws into the top edge of the mains terminal cover.
- Make sure that the cover is securely fastened.



To open the cover of terminal board obey the procedure in opposite sequence.

TERMINAL BOARD



Do not remove blanking plates.

Make sure that the links are fitted as shown.

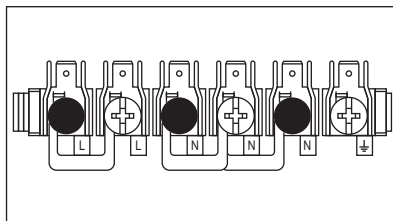

ENERGY EFFICIENCY

PRODUCT INFORMATION FOR HOB ACCORDING TO EU 66/2014

| | | |
|--|--|----------------|
| Model identification | ZCK66350BA ZCK66350WA ZCK66350XA | |
| Type of hob | Hob inside Freestanding Cooker | |
| Number of gas burners | 4 | |
| Energy efficiency per gas burner (EE gas burner) | Left Front - Rapid | 55.0 % |
| | Left rear - Semi Rapid | 55.6 % |
| | Right front - Auxiliary | not applicable |
| | Right rear- Semi Rapid | 55.6 % |
| Energy efficiency for the gas hob (EE gas hob) | 55.4 % | |

EN 30-2-1: Domestic cooking appliances burning gas - Part 2-1: Rational use of energy - General

HOB - ENERGY SAVING

You can save energy during everyday cooking if you follow below hints.

- When you heat up water, use only the amount you need.
- If it is possible, always put the lids on the cookware.
- Before you use the burners and pan support make sure they are assembled correctly.
- The cookware bottom should have the correct diameters for the burner size.
- Put the cookware directly over the burner and in the centre of it.
- When the liquid starts to boil, turn down the flame to barely simmer the liquid.
- If it is possible, use a pressure cooker. Refer to its user manual.

PRODUCT FICHE AND INFORMATION FOR OVENS ACCORDING TO EU 65-66/2014

| | |
|--|---|
| Supplier's name | Zanussi |
| Model identification | ZCK66350BA ZCK66350WA ZCK66350XA |
| Energy Efficiency Index | Top oven: 105.6 Main oven: 95.4 |
| Energy efficiency class | Top oven: A Main oven: A |
| Energy consumption with a standard load, conventional mode | Top oven: 0.75 kWh/cycle Main oven: not applicable |
| Energy consumption with a standard load, fan-forced mode | Top oven: not applicable Main oven: 0.83 kWh/cycle |
| Number of cavities | 2 |
| Heat source | Electricity |
| Volume | Top oven: 39 l Main oven: 77 l |
| Type of oven | Oven inside Freestanding Cooker |

Mass

| | |
|------------|---------|
| ZCK66350BA | 62.4 kg |
| ZCK66350WA | 62.4 kg |
| ZCK66350XA | 61.9 kg |

EN 60350-1 - Household electric cooking appliances - Part 1: Ranges, ovens, steam ovens and grills - Methods for measuring performance.

OVEN - ENERGY SAVING

The oven contains features which help you save energy during everyday cooking.

Make sure that the oven door is closed properly when the oven operates. Do not open the door too often during cooking. Keep the door gasket clean and make sure it is well fixed in its position.

Use metal cookware to improve energy saving.

When possible, do not preheat the oven before cooking.

Keep breaks between baking as short as possible when you prepare a few dishes at one time.

ENVIRONMENTAL CONCERNS

Recycle materials with the symbol . Put the packaging in relevant containers to recycle it. Help protect the environment and human health by recycling waste of electrical and electronic appliances. Do not dispose of appliances marked

Cooking with fan

When possible, use the cooking functions with fan to save energy.

Residual heat

When the cooking duration is longer than 30 minutes, reduce the oven temperature to minimum 3 - 10 minutes before the end of cooking. The residual heat inside the oven will continue to cook. Use the residual heat to warm up other dishes.

Keep food warm

Choose the lowest possible temperature setting to use residual heat and keep a meal warm.

with the symbol  with the household waste. Return the product to your local recycling facility or contact your municipal office.

WWW.ZANUSSI.COM/SHOP



CE

867338495-B-502018